

## A35867- COMPONENTS

PROJECT	_____
TYPE	_____
NOTES	_____
QUANTITY	_____
DATE	_____

### CP-70-15-42

#### DESCRIPTION

Chicago Plenum New Construction Recessed Frame Kit (70mm (2 3/4")), Max. 14.7W 350mA, Tri-Mode Dimming

#### GENERAL

Division: Architectural

#### PHYSICAL

Fixture Material: Metal

#### ELECTRICAL

Lamp Type: LED

Total Output Wattage (W): 8.4-14.7

Dimming: Phase Dimming (120Vac Only)

Driver Type: Constant Current - Universal

Driver Class: Class 2

Input Voltage (V): 120 - 277

Constant Current (mA): 350

Constant Voltage (V): 28-42

Upon Request: 0-10Vdc dimming / Phase dimming @120Vac only / 277Vac

#### RATINGS AND CERTIFICATIONS

Certified By: Certified for North American Standards

IP rating: Dry

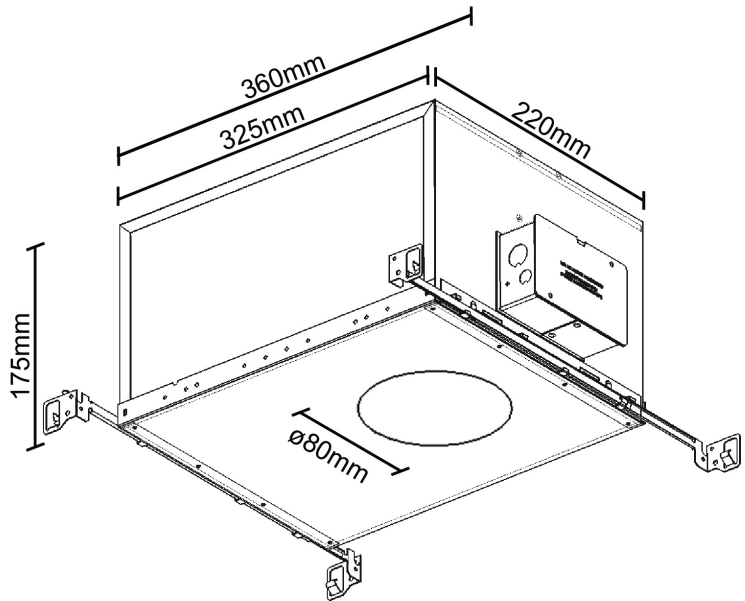
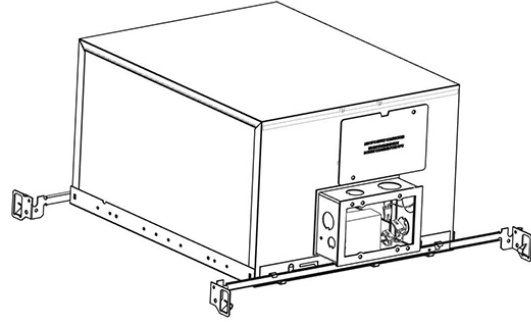

## A35867- COMPONENTS

PROJECT

TYPE

NOTES

QUANTITY

DATE

### DTM0150350ES

#### DESCRIPTION

ERP - ESS015W-0350-42 - 0-10Vdc & Phase [Leading and Trailing Edge @120Vac only] dimming - 15W - 350mA - 120 / 277Vac - LED power supply -Used with ENCP3 -Available with IP68-Outdoor Rated -ENCP20, ENCP22

#### GENERAL

Division: Architectural : Components : LED Drivers

#### PHYSICAL

Length (mm): 84

Length (in): 3 1/2

Width (mm): 40

Width (in): 1 9/16

Height (mm): 25.2

Height (in): 1

Weight (kg): 0.154

Weight (lbs): 0.339

Fixture Material: Plastic

#### ELECTRICAL

Lamp Type: LED

Total Output Wattage (W): 8.4-14.7

Dimming: Tri-Mode (Non-Dimming and Phase Dimming (120Vac only) and 0-10V Dimming)

Driver Type: Constant Current - Universal

Driver Class: Class 2

Input Voltage (V): 120 - 277

Constant Current (MA): 350

Constant Voltage (V): 28-42

Upon Request: 0-10Vdc dimming / Phase dimming @120Vac only / 277Vac

#### RATINGS AND CERTIFICATIONS

Certified By: UR Listed

Code Compliance: Title 24 commercial Installation

IP rating: Dry / Damp

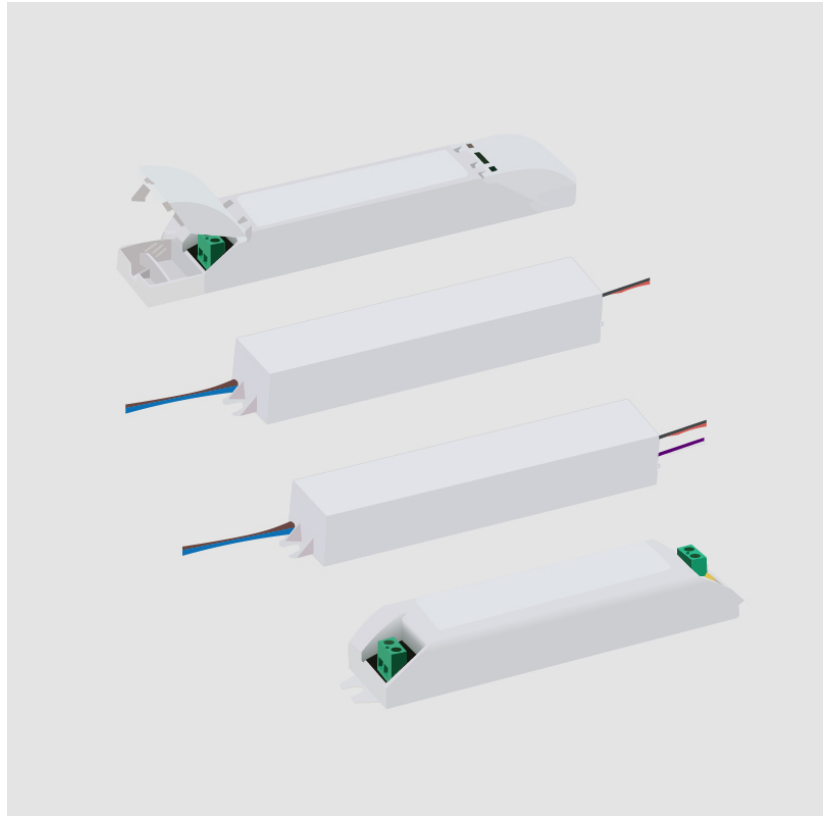

## A35867- COMPONENTS

PROJECT \_\_\_\_\_

TYPE \_\_\_\_\_

NOTES \_\_\_\_\_

QUANTITY \_\_\_\_\_

DATE \_\_\_\_\_

### IC-70-15-42

#### DESCRIPTION

Insulated Ceiling New Construction Recessed Frame Kit (70mm (2 3/4")), Max. 15W 350mA, Tri-Mode Dimming

#### GENERAL

Division: Architectural

#### ELECTRICAL

Dimming: Tri-Mode (Non-Dimming and Phase Dimming (120Vac only) and 0-10V Dimming)

Driver Included: Yes

Constant Current (MA): 250

#### RATINGS AND CERTIFICATIONS

Certified By: CSA Certified to UL and CSA Standards

IP rating: IP20

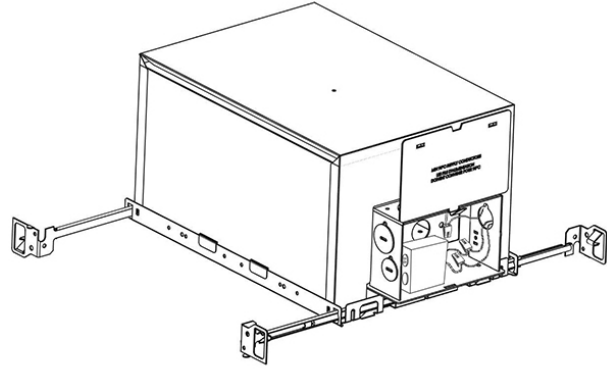

PROJECT	
TYPE	
NOTES	
QUANTITY	
DATE	

## A35867- COMPONENTS

### NC-70-15-42

#### DESCRIPTION

New Construction Recessed Frame Kit (70mm (2 3/4")), Max. 14.7W 350mA - Tri-Mode Dimming

#### GENERAL

Division: Architectural

#### PHYSICAL

Diameter (mm): 70

Length (mm): 316

Width (mm): 219

Height (mm): 19

Min. Recessing Depth (mm): 110

Fixture Material: Metal

#### ELECTRICAL

Lamp Type: LED

Driver Type: Integral 0-10V LED Driver 120/277Vac

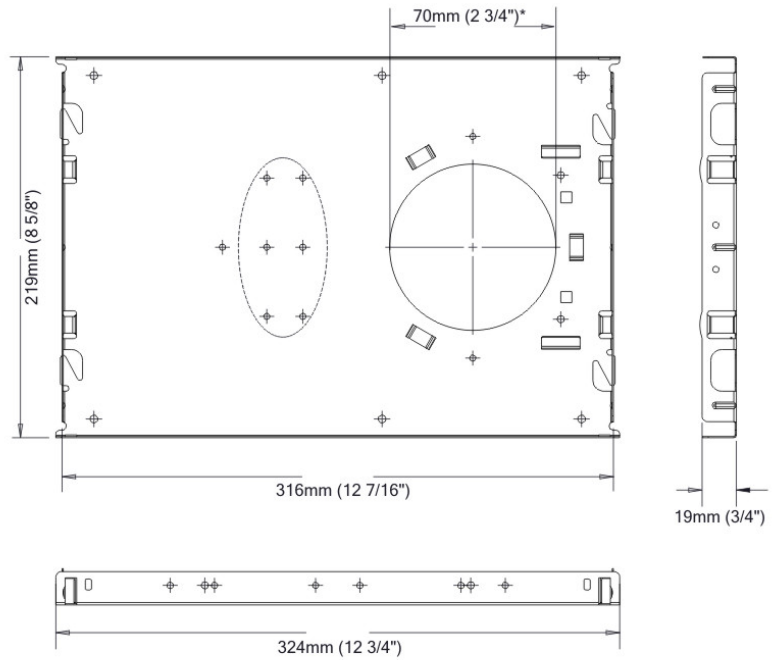

\* The cutout hole is not showing the right scale but the diameter is correct.



## A35867- COMPONENTS

PROJECT

TYPE

NOTES

QUANTITY

DATE

### RM-15-42

#### DESCRIPTION

Remodel Housing Kit, Max. 14.7W 350mA, Tri-Mode Dimming

#### GENERAL

Division: Architectural

#### PHYSICAL

Shape: Rectangle

Length (mm): 155

Length (in): 6 <sup>1</sup>/<sub>64</sub>

Width (mm): 53

Width (in): 2 <sup>7</sup>/<sub>32</sub>

Height (mm): 35

Height (in): 1 <sup>3</sup>/<sub>8</sub>

Fixture Material: Metal

#### ELECTRICAL

Lamp Type: LED

Total Output Wattage (W): 8.4-14.7

Dimming: Tri-Mode (Non-Dimming and Phase Dimming (120Vac only) and 0-10V Dimming)

Driver Included: Yes

Driver Type: Constant Current - Universal

Driver Class: Class 2

Housing: ENCP3







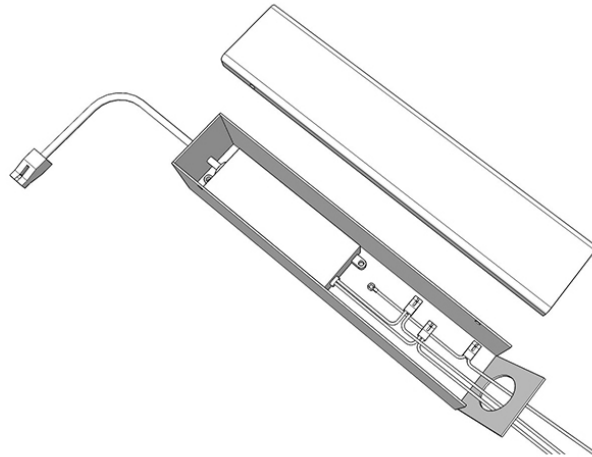
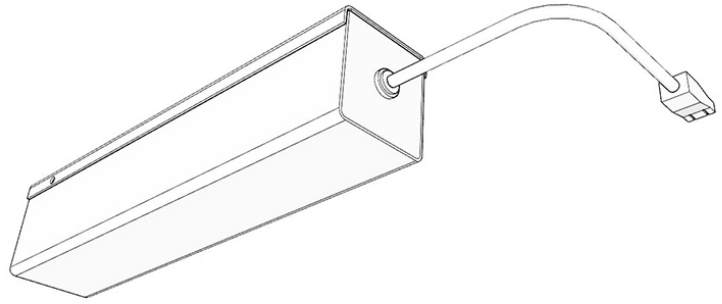





























































Input Voltage (V): 120 - 277

Constant Current (mA): 350











Constant Voltage (V): 28-42













### LEGEND

	floor-mounted		pivotal		special LED (upon request) RGB, RGBW, tunable, gold+, meat+, art+, fashion+
	wall and ceiling: recessed and surface mounted		rotating		warm dim / natural dimming LED
	ceiling-mounted and wall-mounted		illuminate tilted		rechargeable battery powered
	wall-mounted		color of suspension cable		fixture with natural vivid LED (upon request)
	omni-directional light distribution		length of suspension cable		color rendering index
	direct light distribution		reflector degree selection		color temperature
	direct/indirect light distribution		super spot		lumen (luminous flux)
	indirect light distribution		lens		efficacy (lumens per watt)
	asymmetric light distribution		lens pack		Unified Glare Rating (UGR) range from 5-40
	aura light distribution		shine ring		marine grade (AISI 316 stainless steel)
	round wall or ceiling cut-out		integrated shine ring with diffuser		walk on
	square wall or ceiling cut-out		free individual colors 01-29		drive on
	the supplied jig specifies the cutout dimensions		individual colors: 00 (free of charge), 01-25 (extra charge)		Dark Sky Compliance
	minimum distance (meters) lamp - object		luminaire part to be colored (F1)		Americans with Disabilities Act (less than 4" off the wall located between 27"-84" from floor)
	recessed depth		luminaire part to be colored (F2)		lamp protected against explosion
	ceiling thickness in mm		luminaire part to be colored (F3)		blown glass using traditional methods by master glass blower
	ceiling thickness selection		luminaire part to be colored (F4)		acoustic material
	dimnable DP (phase), DV (0-10V), DD (dali), DS (step-dim)		luminaire part to be colored (F5)		protection class I, protection insulation
	included or excluded LED driver/transformer/control gear		color of 3-circuit adaptor		protection class II, protection insulation
	separately switchable		indirect diffuser		ETL Certified to UL and CSA Standards
	sensor		direct diffuser		UL Certified to UL and CSA Standards
	remote control		ball-proof (upon request)		CSA Certified to UL and CSA Standards
	available upon request		accessory		Certified for North American Standards

### IP RATING

	protected against ingress of solid bodies greater than 12.5mm (finger)
	protected against ingress of solid bodies greater than 2.5mm protected against sprays of water up to 60 degrees from the vertical (rain)
	protected against ingress of solid bodies greater than 1mm (wire) no protection against the ingress of moisture
	protected against ingress of solid bodies greater than 1mm (wire) protected against sprays of water up to 60 degrees from the vertical (rain)
	protected against ingress of solid bodies greater than 1mm (wire) protected against water splashed from all directions
	protected against limited ingress of dust (wet rooms/covered outdoor areas) protected against water splashed from all directions
	protected against ingress of dust protected against jets of water
	protected against ingress of dust protected against powerful jets of water or heavy seas
	protected against ingress of dust protected against immersion of water between 15cm - 1m for 30 minutes
	protected against ingress of dust protected against immersion of water under pressure for long periods

### IK RATING

	protected against 0.14 joules impact (equivalent to 0.25kg mass dropped from 56mm above the surface)
	protected against 0.2 joules impact (equivalent to 0.25kg mass dropped from 80mm above the surface)
	protected against 0.35 joules impact (equivalent to 0.25kg mass dropped from 140mm above the surface)
	protected against 0.5 joules impact (equivalent to 0.25kg mass dropped from 200mm above the surface)
	protected against 0.7 joules impact (equivalent to 0.25kg mass dropped from 280mm above the surface)
	protected against 1 joules impact (equivalent to 0.25kg mass dropped from 400mm above the surface)
	protected against 2 joules impact (equivalent to 0.5kg mass dropped from 400mm above the surface)
	protected against 5 joules impact (equivalent to 1.7kg mass dropped from 300mm above the surface)
	protected against 10 joules impact (equivalent to 5.0kg mass dropped from 200mm above the surface)
	protected against 20 joules impact (equivalent to 5.0kg mass dropped from 400mm above the surface)