

A3GB-SUR-SYS COMPONENTS

PROJECT	_____
TYPE	_____
NOTES	_____
QUANTITY	_____
DATE	_____

A380041-

DESCRIPTION

Hangover Plug Shine - Track Head - 28mm / 1 1/8" x 300mm / 11 13/16" - 6.4W LED (Zhaga Standard) - 2700K / 3000K / 4000K - Lens 24°/32°/ 58°

GENERAL

Series: Hangover
 Subseries: Hangover Plug Standard (Track Insert)
 Partner: Prolicht
 Division: Architectural
 Light Distribution: Downlight

PHYSICAL

Aperture Sizes - Downlights: 1"
 Shape: Cylinder
 Diameter (mm): 28
 Diameter (in): 1 1/8"
 Height (mm): 350
 Height (in): 13 3/4"
 Weight (kg): 0.451
 Weight (lbs): 0.99
 Diffuser: Shine Ring 1-6
 Fixture Finish: SSR / BKV / CWI / CRY / HAB / UFT / ITA / RUA / FTG / MYG / LOD / PUS / FRO / FUP / KIA / POP / BLS / SPG / MEY / GOH / CHC / COM / ABZ / JAG / OBR / MOS / ROR
 Fixture Material: Aluminum
 Cable Details: 2,000mm or 4,000mm Cable - Black

ELECTRICAL

Input Wattage Range: 1 - 9 W
 Lamp Type: LED (Zhaga Standard)
 Input Wattage (W): 6.4
 Total Output Wattage (W): 5.8
 Dimming: 0-10V Dimming
 Driver Included: No
 Driver Location: External
 Input Voltage (V): 120

LED

Delivered Lumen Range: 100 - 499 lm
 Number of LEDs: 1
 Color Temperature (°K): 2700 / 3000 / 4000
 Max. Delivered Lumen (lm): 328 / 363 / 386
 Nominal Lumen (lm): 448 / 483 / 514
 CRI: >90 CRI
 Upon Request: Special Color Temperature

OPTICAL

Optic°: 24 / 32 / 58
 Upon Request: Special Beam Angles

RATINGS AND CERTIFICATIONS

Certified By: Certified for North American Standards
 IP rating: IP20



A3GB-SUR-SYS COMPONENTS

A380044-

DESCRIPTION
 Hangover Plug Decor - Blank Track Head - 28mm / 1 1/8" x 450mm / 17 11/16" -

GENERAL
 Series: Hangover
 Subseries: Hangover Plug Standard (Track Insert)
 Partner: Prolicht
 Division: Architectural

PHYSICAL
 Aperture Sizes - Downlights: 1"
 Shape: Cylinder
 Diameter (mm): 28
 Diameter (in): 1 1/8
 Height (mm): 450
 Height (in): 17 11/16
 Weight (kg): 0.32
 Weight (lbs): 0.706
 Fixture Finish: SSR / BKV / CWI / CRY / HAB / UFT / ITA / RUA / FTG / MYG / LOD / PUS / FRO / FUP / KIA / POP / BLS / SPG / MEY / GOH / CHC / COM / ABZ / JAG / OBR / MOS / ROR
 Fixture Material: Aluminum Die Cast

ELECTRICAL
 Lamp Type: LED (Zhaga Standard)

RATINGS AND CERTIFICATIONS
 Certified By: Certified for North American Standards
 IP rating: IP20

PROJECT	_____
TYPE	_____
NOTES	_____
QUANTITY	_____
DATE	_____

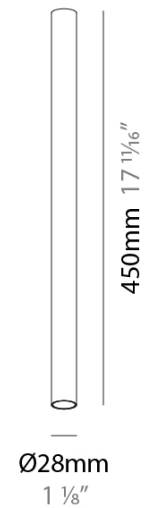
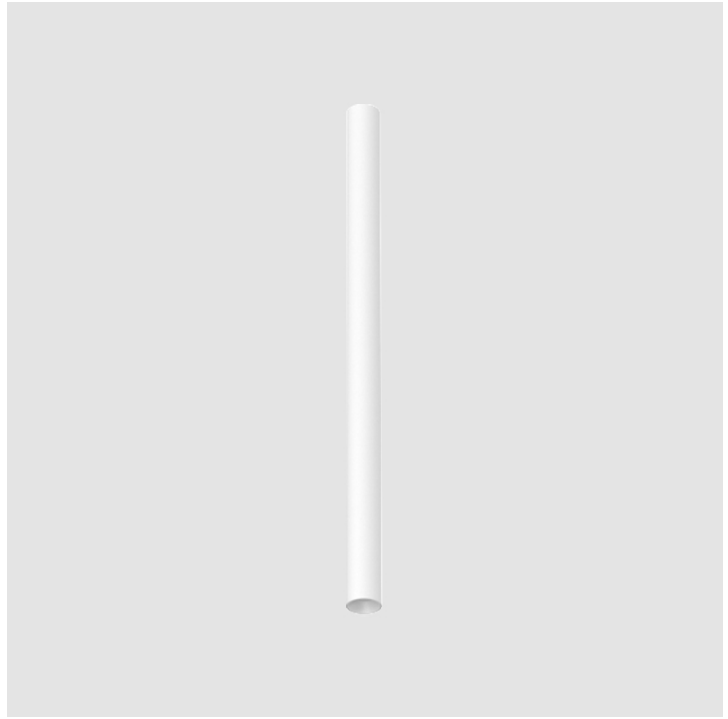

A3GB-SUR-SYS COMPONENTS

PROJECT _____
TYPE _____
NOTES _____
QUANTITY _____
DATE _____

A380106-

DESCRIPTION
Hangover 75 - Indirect Diffuser

GENERAL
Series: Hangover _____
Subseries: Hangover 75 _____
Partner: Prolicht _____
Division: Architectural _____

PHYSICAL
Shape: Round _____
Diameter (mm): 70 _____
Diameter (in): 2 7/8 _____
Fixture Finish: RED / ORG / YEL / GRN / BLU _____
Fixture Material: Acrylic _____

RATINGS AND CERTIFICATIONS
Certified By: Certified for North American Standards _____
IP rating: IP20 _____

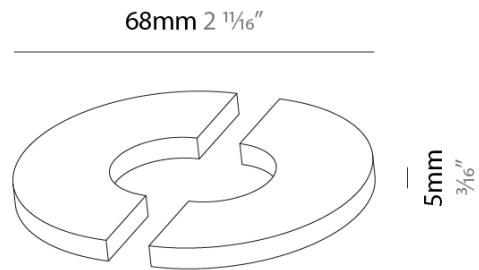

PROJECT	_____
TYPE	_____
NOTES	_____
QUANTITY	_____
DATE	_____

A3GB-SUR-SYS COMPONENTS SURFACE

A380107-

DESCRIPTION
 Hangover Plug 40 - 150mm / 5 7/8" - 10.9W LED (Zhaga Standard) - 2700K / 3000K / 4000K - Dimmable - Reflector 40° / 50°

GENERAL
 Series: Hangover
 Subseries: Hangover Plug 40
 Partner: Prolicht
 Division: Architectural
 Installation: Surface
 Product Type: Downlight
 Mounting Location: Ceiling
 Light Distribution: Downlight

PHYSICAL
 Aperture Sizes - Downlights: 1"
 Shape: Cylinder
 Diameter (mm): 40
 Diameter (in): 1 9/16
 Height (mm): 150
 Height (in): 5 7/8
 Weight (kg): 0.452
 Weight (lbs): 9.96
 Diffuser: Shine Ring 1-6
 Fixture Finish: SSR / BKV / CWI / CRY / HAB / UFT / ITA / RUA / FTG / MYG / LOD / PUS / FRO / FUP / KIA / POP / BLS / SPG / MEY / GOH / CHC / COM / ABZ / JAG / OBR / MOS / ROR
 Fixture Material: Aluminum

ELECTRICAL
 Input Wattage Range: 10 - 19 W
 Lamp Type: LED (Zhaga Standard)
 Input Wattage (W): 10.9
 Total Output Wattage (W): 10
 Dimming: 0-10V Dimming
 Driver Included: No
 Input Voltage (V): 48

LED
 Delivered Lumen Range: 500 - 999 lm
 Color Temperature (°K): 2700 / 3000 / 4000
 Max. Delivered Lumen (lm): 788 / 829 / 840
 Nominal Lumen (lm): 1016 / 1068 / 1082
 CRI: >90 CRI
 Lamp Life (hrs): 50000

OPTICAL
 Reflector: 40 / 50

RATINGS AND CERTIFICATIONS
 Certified By: Certified for North American Standards
 IP rating: IP20

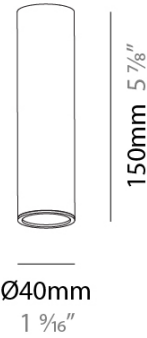

PROJECT	_____
TYPE	_____
NOTES	_____
QUANTITY	_____
DATE	_____

A3GB-SUR-SYS COMPONENTS SURFACE

A380111-

DESCRIPTION

Hangover Plug 75 - Track Head -150mm / 5 7/8" - 6.6W LED
(Zhaga Standard) - 2700K / 3000K / 4000K - Dimmable - Lens 9° /
24° / 39°

GENERAL

Series: Hangover _____
Subseries: Hangover Plug 75 _____
Partner: Prolicht _____
Division: Architectural _____
Installation: Surface _____
Product Type: Downlight _____
Mounting Location: Ceiling _____
Light Distribution: Downlight _____

PHYSICAL

Aperture Sizes - Downlights: 2" _____
Shape: Cylinder _____
Diameter (mm): 75 _____
Diameter (in): 2 15/16 _____
Height (mm): 150 _____
Height (in): 5 7/8 _____
Weight (kg): 0.532 _____
Weight (lbs): 1.17 _____
Diffuser: Shine Ring 1-6 _____
Fixture Finish: SSR / BKV / CWI / CRY / HAB / UFT / ITA / RUA / FTG /
MYG / LOD / PUS / FRO / FUP / KIA / POP / BLS / SPG / MEY / GOH /
CHC / COM / ABZ / JAG / OBR / MOS / ROR _____
Fixture Material: Aluminum _____

ELECTRICAL

Input Wattage Range: 1 - 9 W _____
Lamp Type: LED (Zhaga Standard) _____
Input Wattage (W): 6.6 _____
Total Output Wattage (W): 6 _____
Dimming: 0-10V Dimming _____
Driver Included: No _____
Input Voltage (V): 48 _____

LED

Delivered Lumen Range: 100 - 499 lm _____
Color Temperature (°K): 2700 / 3000 / 4000 _____
Max. Delivered Lumen (lm): 385 / 408 / 442 _____
Nominal Lumen (lm): 455.22 / 482 / 522.17 _____
CRI: >90 CRI _____
Lamp Life (hrs): 50000 _____

OPTICAL

Optic°: 9 / 24 / 39 _____

RATINGS AND CERTIFICATIONS

Certified By: Certified for North American Standards _____
IP rating: IP20 _____

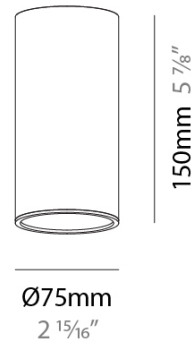

A3GB-SUR-SYS COMPONENTS

PROJECT	_____
TYPE	_____
NOTES	_____
QUANTITY	_____
DATE	_____

A38818-

DESCRIPTION
 Snooker Decor - Track - Blank Globe - _____

GENERAL
 Series: Snooker _____
 Partner: Prolicht _____
 Division: Architectural _____

PHYSICAL
 Shape: Round _____
 Diameter (mm): 72 _____
 Diameter (in): 2 ¹³/₁₆ _____
 Height (mm): 72 _____
 Height (in): 2 ¹³/₁₆ _____
 Weight (kg): 0.733 _____
 Weight (lbs): 1.62 _____
 Fixture Finish: SSR / BKV / CWI / CRY / HAB / UFT / ITA / RUA / FTG / MYG / LOD / PUS / FRO / FUP / KIA / POP / BLS / SPG / MEY / GOH / CHC / COM / ABZ / JAG / OBR / MOS / ROR _____
 Fixture Material: Aluminum Die Cast _____

RATINGS AND CERTIFICATIONS
 Certified By: Certified for North American Standards _____
 IP rating: IP20 _____

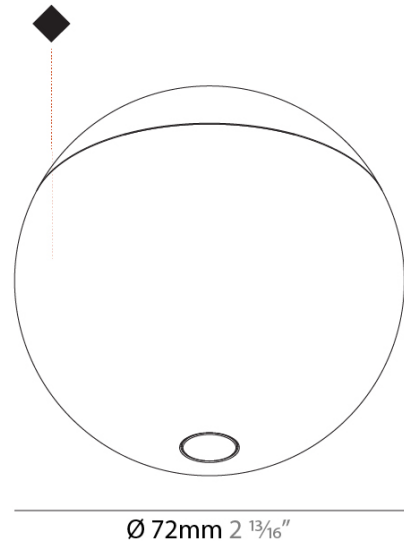

A3GB-SUR-SYS COMPONENTS

A38862-

DESCRIPTION
 Snooker - Track- Suspension Insert for Gravity Lift - 6.4W LED
 (Zhaga Standard) - 2700K / 3000K / 4000K

GENERAL

Series: Snooker _____
 Partner: Prolicht _____
 Division: Architectural _____
 Light Distribution: Downlight _____

PHYSICAL

Shape: Round _____
 Diameter (mm): 72 _____
 Diameter (in): 2 13/16 _____
 Height (mm): 72 _____
 Height (in): 2 13/16 _____
 Weight (kg): 0.733 _____
 Weight (lbs): 1.62 _____
 Fixture Finish: SSR / BKV / CWI / CRY / HAB / UFT / ITA / RUA / FTG /
 MYG / LOD / PUS / FRO / FUP / KIA / POP / BLS / SPG / MEY / GOH /
 CHC / COM / ABZ / JAG / OBR / MOS / ROR _____
 Fixture Material: Aluminum Die Cast _____

ELECTRICAL

Input Wattage Range: 1 - 9 W _____
 Lamp Type: LED (Zhaga Standard) _____
 Input Wattage (W): 6.5 _____
 Total Output Wattage (W): 5.8 _____
 Dimming: 0-10V Dimming _____
 Driver Included: No _____
 Driver Location: External _____
 Input Voltage (V): 48 _____
 Constant Current (MA): 500 _____

LED

Delivered Lumen Range: 100 - 499 lm _____
 Number of LEDs: 1 _____
 Color Temperature (°K): 2700 / 3000 / 4000 _____
 Max. Delivered Lumen (lm): 270 / 290 / 310 _____
 Nominal Lumen (lm): 448 / 483 / 514 _____
 CRI: >90 CRI _____
 Upon Request: Special Color Temperature 3500K available in
 minimum quantities (larger quantities upon request) _____

OPTICAL

Beam Angle: 55 _____
 Upon Request: 55° Beam Angle: Dual Focus lens technology - very
 low UGR _____

RATINGS AND CERTIFICATIONS

Certified By: Certified for North American Standards _____
 IP rating: IP20 _____

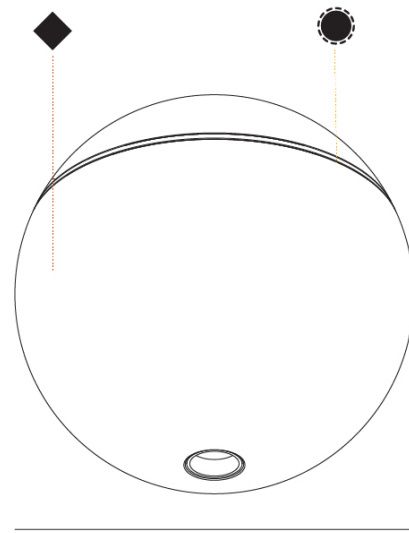

Ø 72mm 2 13/16"



PROJECT _____
 TYPE _____
 NOTES _____
 QUANTITY _____
 DATE _____

A3GB-SUR-SYS COMPONENTS

A38866-

DESCRIPTION
 Snooker - G-Board - Suspension Insert - 6.4W LED (Zhaga Standard) - 2700K / 3000K / 4000K including Cable

GENERAL
 Series: Snooker _____
 Partner: Prolicht _____
 Division: Architectural _____
 Light Distribution: Downlight _____

PHYSICAL
 Shape: Round _____
 Diameter (mm): 72 _____
 Diameter (in): 2 13/16 _____
 Height (mm): 72 _____
 Height (in): 2 13/16 _____
 Weight (kg): 0.733 _____
 Weight (lbs): 1.6 _____
 Fixture Finish: SSR / BKV / CWI / CRY / HAB / UFT / ITA / RUA / FTG / MYG / LOD / PUS / FRO / FUP / KIA / POP / BLS / SPG / MEY / GOH / CHC / COM / ABZ / JAG / OBR / MOS / ROR _____
 Fixture Material: Aluminum Die Cast _____

ELECTRICAL
 Input Wattage Range: 1 - 9 W _____
 Lamp Type: LED (Zhaga Standard) _____
 Input Wattage (W): 6.5 _____
 Total Output Wattage (W): 5.8 _____
 Driver Included: No _____
 Driver Location: External _____
 Input Voltage (V): 48 _____
 Constant Current (MA): 500 _____

LED
 Delivered Lumen Range: 100 - 499 lm _____
 Number of LEDs: 1 _____
 Color Temperature (°K): 2700 / 3000 / 4000 _____
 Max. Delivered Lumen (lm): 270 / 290 / 310 _____
 Nominal Lumen (lm): 448 / 483 / 514 _____
 CRI: >90 CRI _____
 Upon Request: Special Color Temperature 3500K available in minimum quantities (larger quantities upon request) _____

OPTICAL
 Beam Angle: 55 _____
 Upon Request: 55° Beam Angle: Dual Focus lens technology - very low UGR _____

RATINGS AND CERTIFICATIONS
 Certified By: Certified for North American Standards _____
 IP rating: IP20 _____

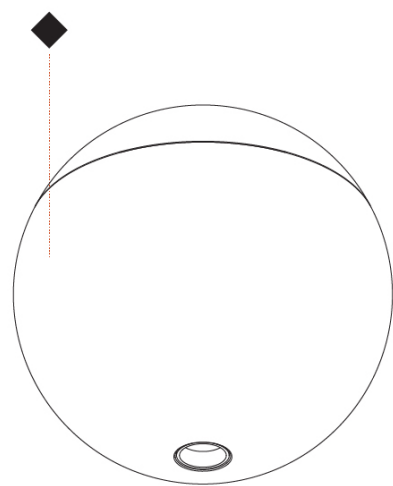
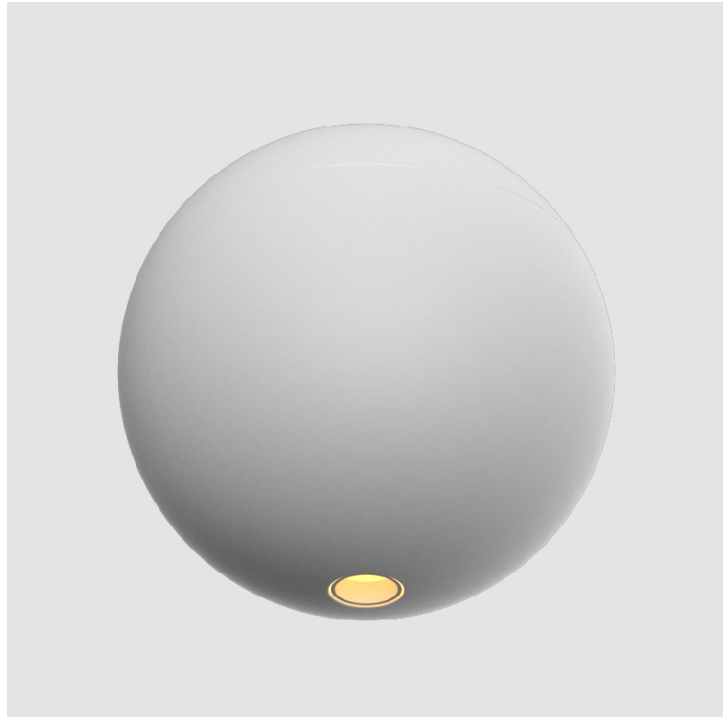

Ø 72mm 2 13/16"



PROJECT	_____
TYPE	_____
NOTES	_____
QUANTITY	_____
DATE	_____

A3GB-SUR-SYS COMPONENTS SURFACE

A38950-

DESCRIPTION
G-Board for Gravity Lift - Surface

GENERAL

Series: G-Board
Subseries: G-Board Standard
Partner: Prolicht
Division: Architectural
Installation: Surface
Product Type: Modular Systems
Mounting Location: Ceiling

PHYSICAL

Shape: Abstract
Length (mm): 990
Length (in): 39
Width (mm): 745
Width (in): 29 5/16
Height (mm): 50
Height (in): 1 15/16
Weight (kg): 5.205
Weight (lbs): 11.48
Fixture Finish: SSR / BKV / CWI / CRY / HAB / UFT / ITA / RUA / FTG / MYG / LOD / PUS / FRO / FUP / KIA / POP / BLS / SPG / MEY / GOH / CHC / COM / ABZ / JAG / OBR / MOS / ROR
Fixture Material: Aluminum

RATINGS AND CERTIFICATIONS

Certified By: Certified for North American Standards
IP rating: IP20

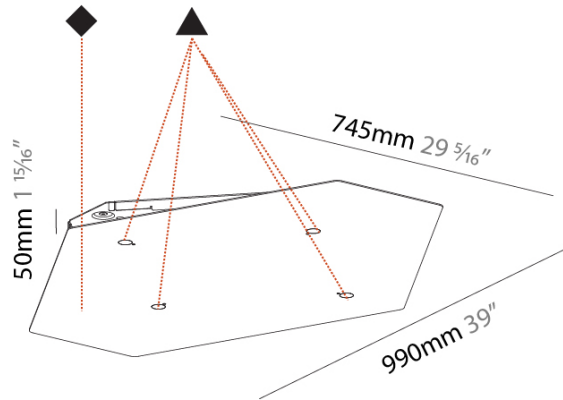
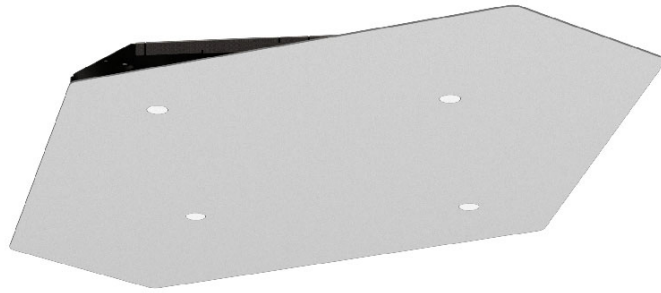

A3GB-SUR-SYS COMPONENTS

PROJECT	_____
TYPE	_____
NOTES	_____
QUANTITY	_____
DATE	_____

A3895199

DESCRIPTION
 G-50 Channel | Gravity Lift - Surface Profile - Mounting Gauge - 1 Pair

GENERAL

Series: G-Board _____
 Partner: Prolight _____
 Division: Architectural _____

PHYSICAL

Shape: Rectangle _____
 Length (mm): 1280 _____
 Length (in): 50 ³/₈ _____
 Width (mm): 25 _____
 Width (in): 1 _____
 Height (mm): 30 _____
 Height (in): 1 ¹/₁₆ _____
 Weight (kg): 1.662 _____
 Weight (lbs): 3.66 _____
 Fixture Material: Aluminum _____

RATINGS AND CERTIFICATIONS

Certified By: Certified for North American Standards _____
 IP rating: IP20 _____

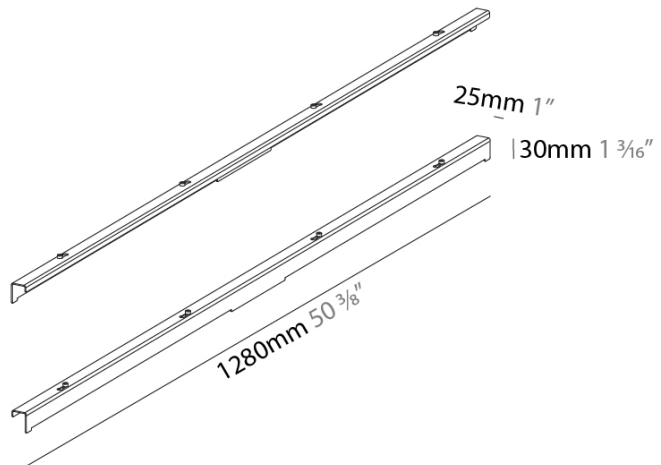
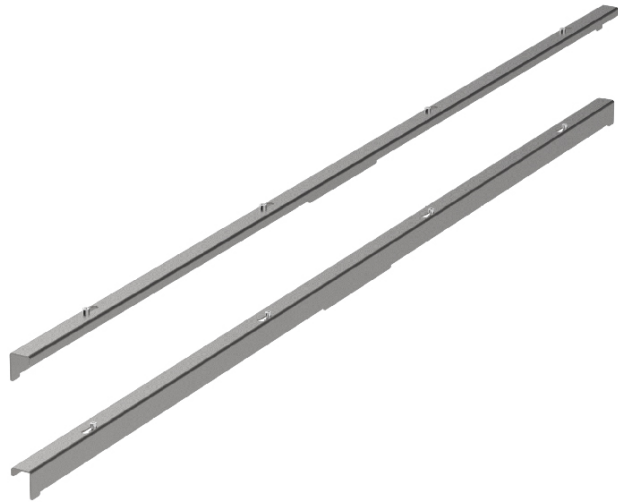

PROJECT _____
 TYPE _____
 NOTES _____
 QUANTITY _____
 DATE _____

A3GB-SUR-SYS COMPONENTS

A38954

DESCRIPTION
 Mechanical Gravity Lift for G-Board

GENERAL
 Series: Snooker
 Subseries: Snooker G-Board for Gravity Lift
 Partner: Prolicht
 Division: Architectural

PHYSICAL
 Shape: Rectangle
 Length (mm): 350
 Length (in): 13 3/4
 Width (mm): 42
 Width (in): 1 5/8
 Height (mm): 105
 Height (in): 4 1/8
 Fixture Material: Aluminum

RATINGS AND CERTIFICATIONS
 Certified By: Certified for North American Standards
 IP rating: IP20

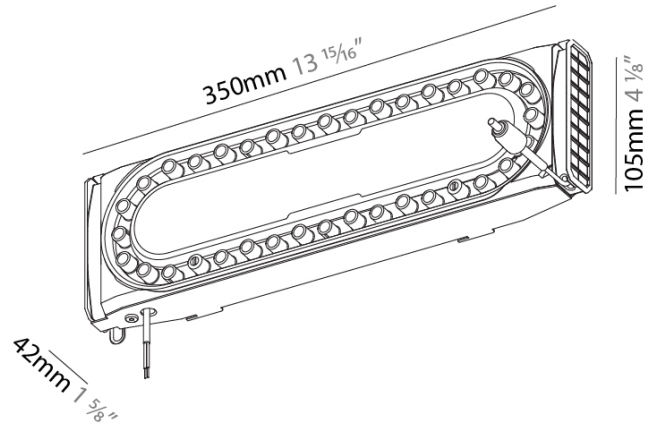

PROJECT _____





































































TYPE _____

NOTES _____











QUANTITY _____

DATE _____











LEGEND

	floor-mounted		pivotable		special LED (upon request) RGB, RGBW, tunable, gold+, meat+, art+, fashion+
	wall and ceiling: recessed and surface mounted		rotating		warm dim / natural dimming LED
	ceiling-mounted and wall-mounted		illuminate tilted		rechargeable battery powered
	wall-mounted		color of suspension cable		fixture with natural vivid LED (upon request)
	omni-directional light distribution		length of suspension cable		color rendering index
	direct light distribution		reflector degree selection		color temperature
	direct/indirect light distribution		super spot		lumen (luminous flux)
	indirect light distribution		lens		efficacy (lumens per watt)
	asymmetric light distribution		lens pack		Unified Glare Rating (UGR) range from 5-40
	aura light distribution		shine ring		marine grade (AISI 316 stainless steel)
	round wall or ceiling cut-out		integrated shine ring with diffuser		walk on
	square wall or ceiling cut-out		free individual colors 01-29		drive on
	the supplied jig specifies the cutout dimensions		individual colors: 00 (free of charge), 01-25 (extra charge)		Dark Sky Compliance
	minimum distance (meters) lamp - object		luminaire part to be colored (F1)		Americans with Disabilities Act (less than 4" off the wall located between 27"-84" from floor)
	recessed depth		luminaire part to be colored (F2)		lamp protected against explosion
	ceiling thickness in mm		luminaire part to be colored (F3)		blown glass using traditional methods by master glass blower
	ceiling thickness selection		luminaire part to be colored (F4)		acoustic material
	dimmable DP (phase), DV (0-10V), DD (dali), DS (step-dim)		luminaire part to be colored (F5)		protection class I, protection insulation
	included or excluded LED driver/transformer/control gear		color of 3-circuit adaptor		protection class II, protection insulation
	separately switchable		indirect diffuser		ETL Certified to UL and CSA Standards
	sensor		direct diffuser		UL Certified to UL and CSA Standards
	remote control		ball-proof (upon request)		CSA Certified to UL and CSA Standards
	available upon request		accessory		Certified for North American Standards

IP RATING

	protected against ingress of solid bodies greater than 12.5mm (finger)
	protected against ingress of solid bodies greater than 2.5mm protected against sprays of water up to 60 degrees from the vertical (rain)
	protected against ingress of solid bodies greater than 1mm (wire) no protection against the ingress of moisture
	protected against ingress of solid bodies greater than 1mm (wire) protected against sprays of water up to 60 degrees from the vertical (rain)
	protected against ingress of solid bodies greater than 1mm (wire) protected against water splashed from all directions
	protected against limited ingress of dust (wet rooms/covered outdoor areas) protected against water splashed from all directions
	protected against ingress of dust protected against jets of water
	protected against ingress of dust protected against powerful jets of water or heavy seas
	protected against ingress of dust protected against immersion of water between 15cm - 1m for 30 minutes
	protected against ingress of dust protected against immersion of water under pressure for long periods

IK RATING

	protected against 0.14 joules impact (equivalent to 0.25kg mass dropped from 56mm above the surface)
	protected against 0.2 joules impact (equivalent to 0.25kg mass dropped from 80mm above the surface)
	protected against 0.35 joules impact (equivalent to 0.25kg mass dropped from 140mm above the surface)
	protected against 0.5 joules impact (equivalent to 0.25kg mass dropped from 200mm above the surface)
	protected against 0.7 joules impact (equivalent to 0.25kg mass dropped from 280mm above the surface)
	protected against 1 joules impact (equivalent to 0.25kg mass dropped from 400mm above the surface)
	protected against 2 joules impact (equivalent to 0.5kg mass dropped from 400mm above the surface)
	protected against 5 joules impact (equivalent to 1.7kg mass dropped from 300mm above the surface)
	protected against 10 joules impact (equivalent to 5.0kg mass dropped from 200mm above the surface)
	protected against 20 joules impact (equivalent to 5.0kg mass dropped from 400mm above the surface)