

D14DAO-MOD-SYS COMPONENTS SUSPENSION

D141277-

DESCRIPTION

Dao - Suspension - 100mm - 1 x Max. 8W LED Retrofit - E26 - Ribbed Glass without Canopy

GENERAL

Series: Dao
 Subseries: Dao Modular System
 Partner: Cangini & Tucci
 Division: Design
 Installation: Suspension
 Product Type: Clusters
 Mounting Location: Ceiling

PHYSICAL

Shape: Cylinder
 Diameter (mm): 100
 Diameter (in): 3 ¹⁵/₁₆"
 Height (mm): 370
 Height (in): 14 ⁷/₁₆"
 Max. Overall Height (mm): 1870
 Max. Overall Height (in): 73 ⁵/₈"
 Weight (kg): 1.5
 Weight (lbs): 3.31
 Fixture Finish: AMB / GRN / PNK / RUB / SMK / TOB / TRA
 Holder Finish: CHR
 Fixture Material: Glass / Metal
 Primary Material: Glass - Borosilicate
 Cable Details: 1500mm Cable

ELECTRICAL

Number of Lamps: 1
 Lamp Type: LED Retrofit
 Lamp Shape: A19
 Bulb Included: Bulb Not Included
 Max. Wattage Per Lamp (W): 8
 Lamp Base: E26
 Input Voltage (V): 120
 Upon Request: GU24 / 277Vac

RATINGS AND CERTIFICATIONS

Certified By: Certified for North American Standards
 IP rating: IP20

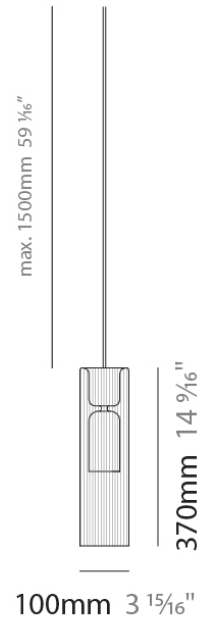

D14DAO-MOD-SYS COMPONENTS

D149001-

DESCRIPTION

Single 120mm - Round Canopy

GENERAL

Partner: Cangini & Tucci

Division: Design

PHYSICAL

Shape: Round

Diameter (mm): 120

Diameter (in): 4 ³/₄

Height (mm): 30

Height (in): 1 ³/₁₆

Fixture Finish: CHR / BCR / MBK / MWH

Fixture Material: Metal

RATINGS AND CERTIFICATIONS

Certified By: Certified for North American Standards

IP rating: IP20

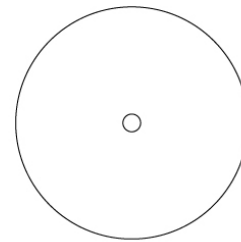

Ø120mm 4 ³/₄"

1 ³/₁₆"
30mm

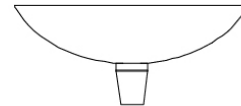

D14DAO-MOD-SYS COMPONENTS

D149006-

DESCRIPTION

Round Canopy - 95mm - 3 Holes

GENERAL

Partner: Cangini & Tucci

Division: Design

PHYSICAL

Shape: Round

Diameter (mm): 120

Diameter (in): 4 ¾

Height (mm): 25

Height (in): 1

Fixture Finish: CHR / BCR / MBK / MWH

Fixture Material: Metal

RATINGS AND CERTIFICATIONS

Certified By: Certified for North American Standards

IP rating: IP20

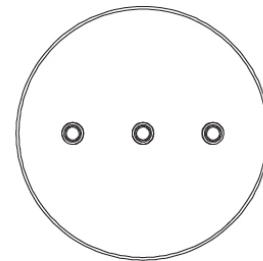

Ø120mm 4 ¾"

1"
25mm



D14DAO-MOD-SYS COMPONENTS

D149007-

DESCRIPTION

Round Canopy - 120mm - 5 Holes

GENERAL

Partner: Cangini & Tucci

Division: Design

PHYSICAL

Shape: Round

Diameter (mm): 120

Diameter (in): 4 ¾

Height (mm): 25

Height (in): 1

Fixture Finish: CHR / BCR / MBK / MWH

Fixture Material: Metal

RATINGS AND CERTIFICATIONS

Certified By: Certified for North American Standards

IP rating: IP20

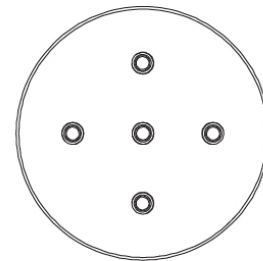

Ø120mm 4 ¾"

1"
25mm



D14DAO-MOD-SYS COMPONENTS

D149008-

DESCRIPTION

Single 120mm - Round Cone Canopy - 2 External Holes + 1 Central Hole

GENERAL

Partner: Cangini & Tucci

Division: Design

PHYSICAL

Shape: Round

Diameter (mm): 120

Diameter (in): 4 3/4

Height (mm): 70

Height (in): 2 3/4

Fixture Finish: CHR / BCR / MBK / MWH

Fixture Material: Metal

RATINGS AND CERTIFICATIONS

Certified By: Certified for North American Standards

IP rating: IP20

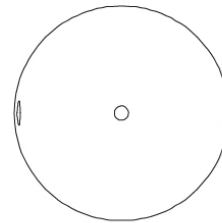
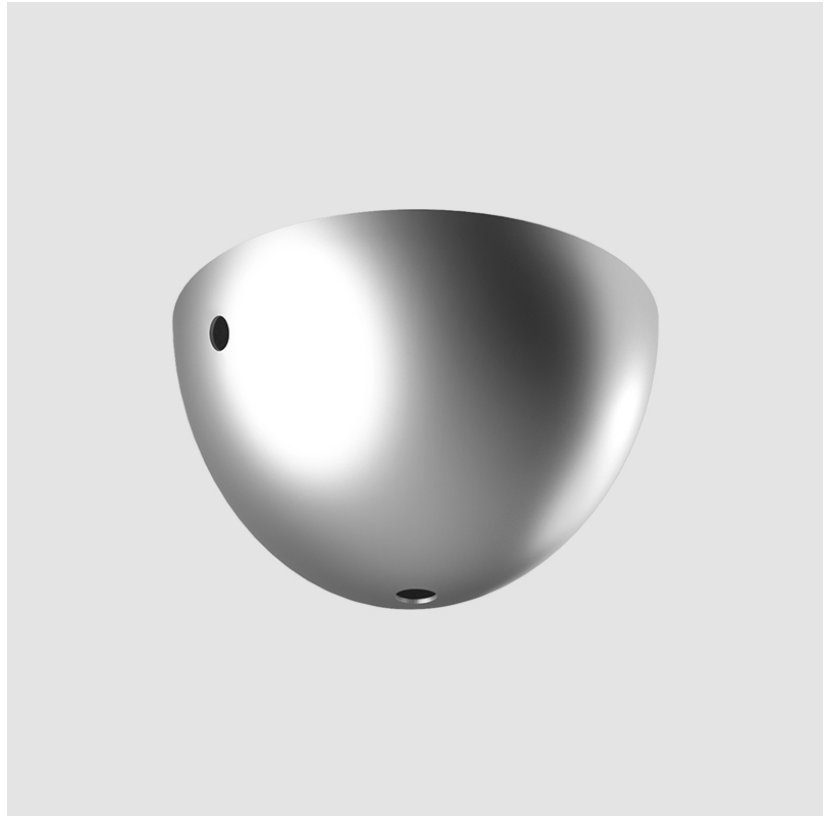

Ø120mm 4 3/4"

70mm 2 3/4"

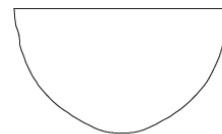

D14DAO-MOD-SYS COMPONENTS

D149009-

DESCRIPTION
 Single 120mm - Round Cone Canopy - 4 External Holes + 1 Central Hole

GENERAL
 Partner: Cangini & Tucci
 Division: Design

PHYSICAL
 Shape: Round
 Diameter (mm): 120
 Diameter (in): 4 3/4
 Height (mm): 90
 Height (in): 3 9/16
 Fixture Finish: CHR / BCR / MBK / MWH
 Fixture Material: Metal

RATINGS AND CERTIFICATIONS
 Certified By: Certified for North American Standards
 IP rating: IP20

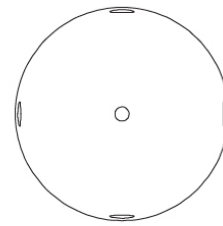

Ø120mm 4 3/4"

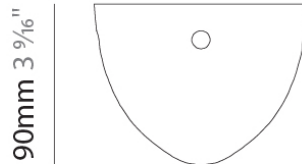

D14DAO-MOD-SYS COMPONENTS

D149012-

DESCRIPTION
 Accessory - Wall Stud Cable Spacer

GENERAL
 Series: Flute
 Partner: Cangini & Tucci
 Division: Design

PHYSICAL
 Fixture Finish: CHR / BCR / MBK / MWH
 Fixture Material: Metal

RATINGS AND CERTIFICATIONS
 Certified By: Certified for North American Standards
 IP rating: IP20

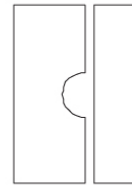
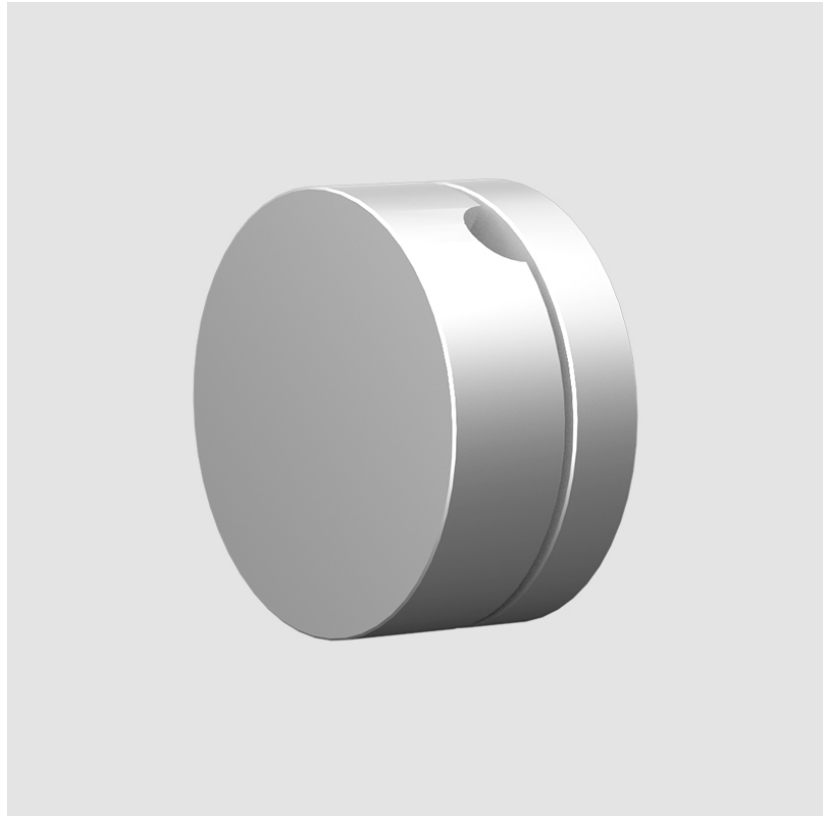

20mm $\frac{13}{16}$ "



10mm $\frac{3}{8}$ "

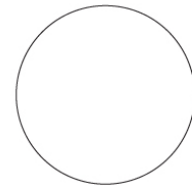

20mm $\frac{13}{16}$ "



PROJECT	
TYPE	
NOTES	
QUANTITY	
DATE	

D14DAO-MOD-SYS COMPONENTS

D149013-

DESCRIPTION

Accessory - Ceiling Cable Spacer

GENERAL

Series: Flute

Partner: Cangini & Tucci

Division: Design

PHYSICAL

Fixture Finish: CHR / BCR / MBK / MWH

Fixture Material: Metal

RATINGS AND CERTIFICATIONS

Certified By: Certified for North American Standards

IP rating: IP20

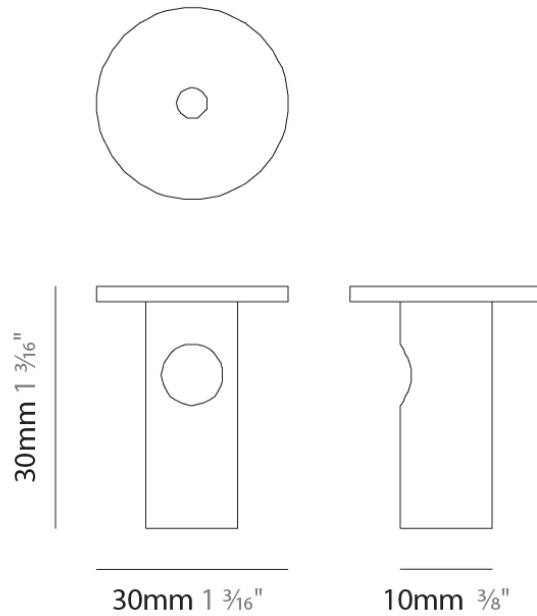

PROJECT	
TYPE	
NOTES	
QUANTITY	
DATE	

D14DAO-MOD-SYS COMPONENTS

D149014-

DESCRIPTION
 Round Canopy - 270mm - for 3 - 5 - 6 lights

GENERAL
 Partner: Cangini & Tucci
 Division: Design

PHYSICAL
 Shape: Round
 Diameter (mm): 270
 Diameter (in): 10 ⁵/₈
 Height (mm): 30
 Height (in): 1 ³/₁₆
 Fixture Finish: CHR / BCR / MBK / MWH
 Fixture Material: Metal

RATINGS AND CERTIFICATIONS
 Certified By: Certified for North American Standards
 IP rating: IP20

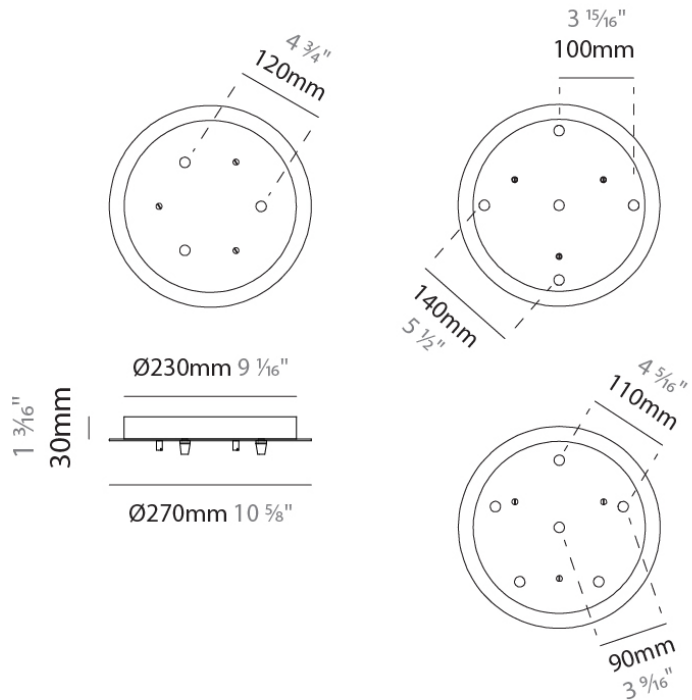

PROJECT	
TYPE	
NOTES	
QUANTITY	
DATE	

D14DAO-MOD-SYS COMPONENTS

D149015-

DESCRIPTION
 Round Canopy - 430mm - for 3 - 5 - 6 - 7 - 8 - 9 - 10 -11 lights

GENERAL
 Partner: Cangini & Tucci
 Division: Design

PHYSICAL
 Shape: Round
 Diameter (mm): 430
 Diameter (in): 16 ¹⁵/₁₆
 Height (mm): 40
 Height (in): 1 ⁹/₁₆
 Fixture Finish: CHR / BCR / MBK / MWH
 Fixture Material: Metal

RATINGS AND CERTIFICATIONS
 Certified By: Certified for North American Standards
 IP rating: IP20

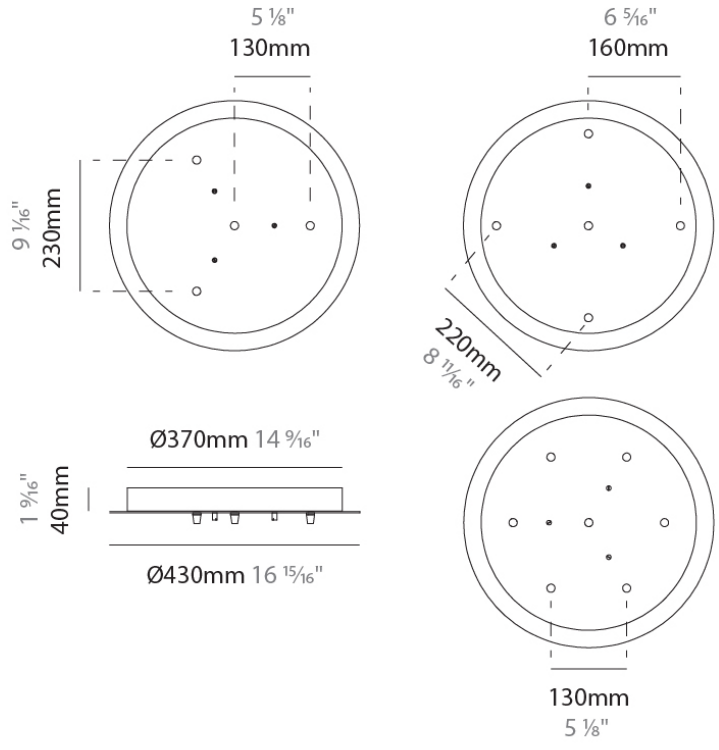

PROJECT	
TYPE	
NOTES	
QUANTITY	
DATE	

D14DAO-MOD-SYS COMPONENTS

D149016-

DESCRIPTION
 Round Canopy - 500mm - for 3 - 4 - 5 lights

GENERAL
 Partner: Cangini & Tucci
 Division: Design

PHYSICAL
 Shape: Round
 Diameter (mm): 500
 Diameter (in): 19 11/16
 Height (mm): 40
 Height (in): 1 9/16
 Fixture Finish: CHR / BCR / MBK / MWH
 Fixture Material: Metal

RATINGS AND CERTIFICATIONS
 Certified By: Certified for North American Standards
 IP rating: IP20

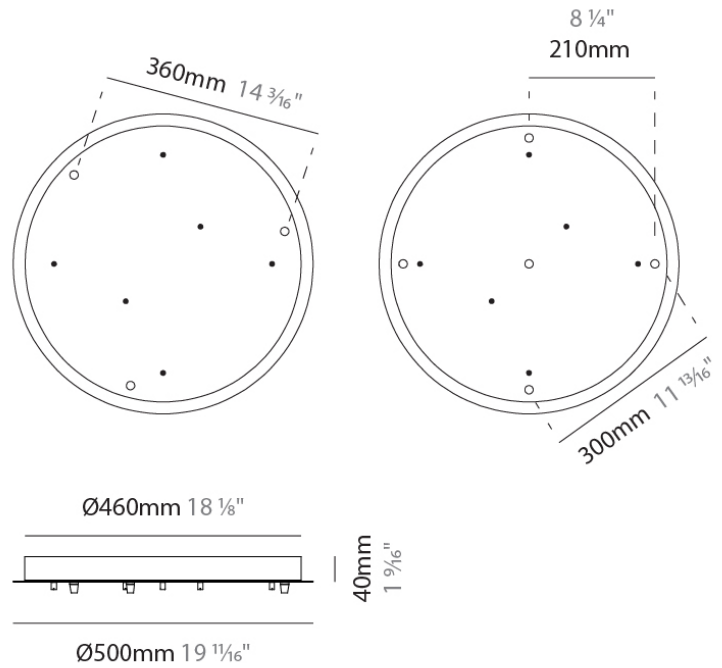

PROJECT	
TYPE	
NOTES	
QUANTITY	
DATE	

D14DAO-MOD-SYS COMPONENTS

D149017-

DESCRIPTION

Square Canopy - 300mm - for 5 lights

GENERAL

Partner: Cangini & Tucci

Division: Design

PHYSICAL

Shape: Square

Length (mm): 300

Length (in): 11 ¹³/₁₆"

Width (mm): 300

Width (in): 11 ¹³/₁₆"

Height (mm): 30

Height (in): 1 ³/₁₆"

Fixture Finish: CHR / BCR / MBK / MWH

Fixture Material: Metal

RATINGS AND CERTIFICATIONS

Certified By: Certified for North American Standards

IP rating: IP20

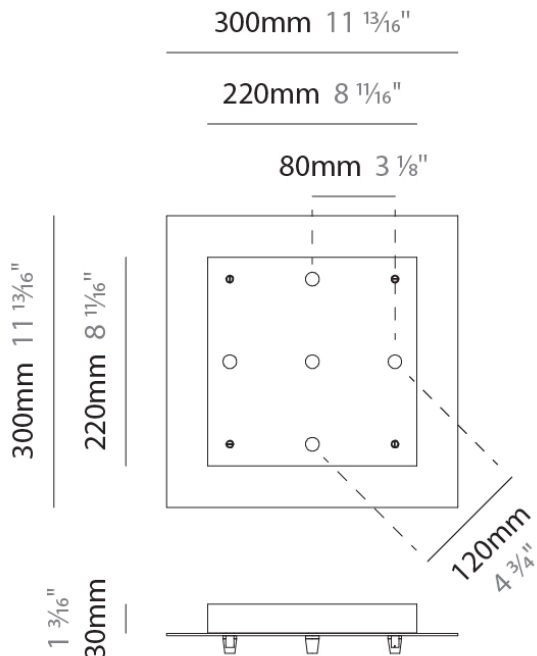

PROJECT	
TYPE	
NOTES	
QUANTITY	
DATE	

D14DAO-MOD-SYS COMPONENTS

D149018-

DESCRIPTION

Square Canopy - 400mm - for 5 lights

GENERAL

Partner: Cangini & Tucci

Division: Design

PHYSICAL

Shape: Square

Length (mm): 400

Length (in): 15 3/4

Width (mm): 400

Width (in): 15 3/4

Height (mm): 30

Height (in): 1 3/16

Fixture Finish: CHR / BCR / MBK / MWH

Fixture Material: Metal

RATINGS AND CERTIFICATIONS

Certified By: Certified for North American Standards

IP rating: IP20

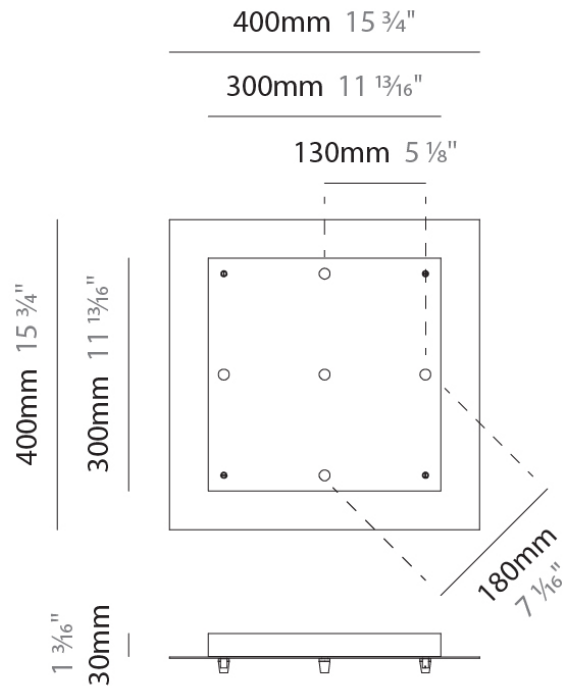

D14DAO-MOD-SYS COMPONENTS

PROJECT	
TYPE	
NOTES	
QUANTITY	
DATE	

D149019-

DESCRIPTION
Slim Linear Canopy - 300mm - 2 lights

GENERAL
Partner: Cangini & Tucci
Division: Design

PHYSICAL
Shape: Rectangle
Length (mm): 300
Length (in): 11 ¹³/₁₆"
Width (mm): 30
Width (in): 1 ³/₁₆"
Height (mm): 30
Height (in): 1 ³/₁₆"
Fixture Finish: CHR / BCR / MBK / MWH
Fixture Material: Metal

RATINGS AND CERTIFICATIONS
Certified By: Certified for North American Standards
IP rating: IP20

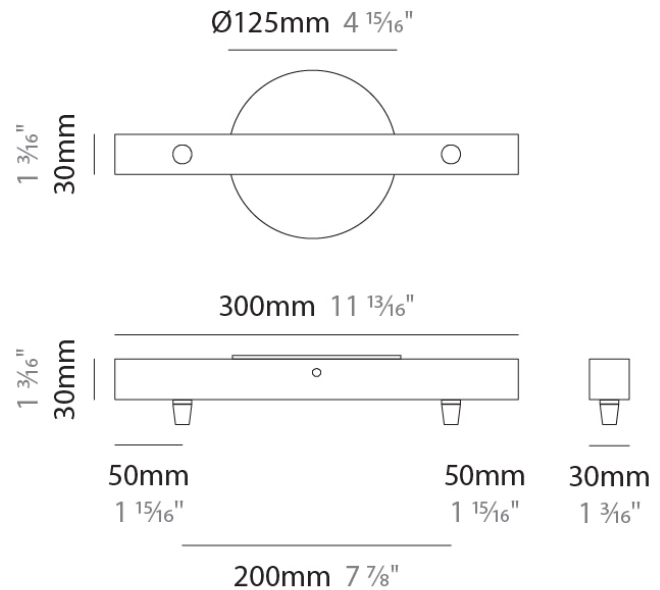

D14DAO-MOD-SYS COMPONENTS

PROJECT	
TYPE	
NOTES	
QUANTITY	
DATE	

D149020-

DESCRIPTION
Slim Linear Canopy - 500mm - 3 lights

GENERAL
Partner: Cangini & Tucci
Division: Design

PHYSICAL
Shape: Rectangle
Length (mm): 500
Length (in): 19 11/16
Width (mm): 30
Width (in): 1 3/16
Height (mm): 30
Height (in): 1 3/16
Fixture Finish: CHR / BCR / MBK / MWH
Fixture Material: Metal

RATINGS AND CERTIFICATIONS
Certified By: Certified for North American Standards
IP rating: IP20

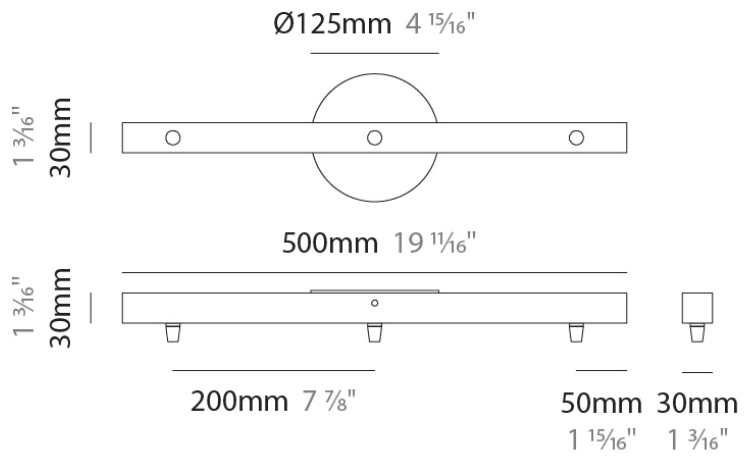

D14DAO-MOD-SYS COMPONENTS

LEGEND

	floor-mounted		pivotable		special LED (upon request) RGB, RGBW, tunable, gold+, meat+, art+, fashion+
	wall and ceiling: recessed and surface mounted		rotating		warm dim / natural dimming LED
	ceiling-mounted and wall-mounted		illuminate tilted		rechargeable battery powered
	wall-mounted		color of suspension cable		fixture with natural vivid LED (upon request)
	omni-directional light distribution		length of suspension cable		color rendering index
	direct light distribution		reflector degree selection		color temperature
	direct/indirect light distribution		super spot		lumen (luminous flux)
	indirect light distribution		lens		efficacy (lumens per watt)
	asymmetric light distribution		lens pack		Unified Glare Rating (UGR) range from 5-40
	aura light distribution		shine ring		marine grade (AISI 316 stainless steel)
	round wall or ceiling cut-out		integrated shine ring with diffuser		walk on
	square wall or ceiling cut-out		free individual colors 01-29		drive on
	the supplied jig specifies the cutout dimensions		individual colors: 00 (free of charge), 01-25 (extra charge)		Dark Sky Compliance
	minimum distance (meters) lamp - object		luminaire part to be colored (F1)		Americans with Disabilities Act (less than 4" off the wall located between 27"-84" from floor)
	recessed depth		luminaire part to be colored (F2)		lamp protected against explosion
	ceiling thickness in mm		luminaire part to be colored (F3)		blown glass using traditional methods by master glass blower
	ceiling thickness selection		luminaire part to be colored (F4)		acoustic material
	dimmable DP (phase), DV (0-10V), DD (dali), DS (step-dim)		luminaire part to be colored (F5)		protection class I, protection insulation
	included or excluded LED driver/transformer/control gear		color of 3-circuit adaptor		protection class II, protection insulation
	separately switchable		indirect diffuser		ETL Certified to UL and CSA Standards
	sensor		direct diffuser		UL Certified to UL and CSA Standards
	remote control		ball-proof (upon request)		CSA Certified to UL and CSA Standards
	available upon request		accessory		Certified for North American Standards

IP RATING

	protected against ingress of solid bodies greater than 12.5mm (finger)
	protected against ingress of solid bodies greater than 2.5mm protected against sprays of water up to 60 degrees from the vertical (rain)
	protected against ingress of solid bodies greater than 1mm (wire) no protection against the ingress of moisture
	protected against ingress of solid bodies greater than 1mm (wire) protected against sprays of water up to 60 degrees from the vertical (rain)
	protected against ingress of solid bodies greater than 1mm (wire) protected against water splashed from all directions
	protected against limited ingress of dust (wet rooms/covered outdoor areas) protected against water splashed from all directions
	protected against ingress of dust protected against jets of water
	protected against ingress of dust protected against powerful jets of water or heavy seas
	protected against ingress of dust protected against immersion of water between 15cm - 1m for 30 minutes
	protected against ingress of dust protected against immersion of water under pressure for long periods

IK RATING

	protected against 0.14 joules impact (equivalent to 0.25kg mass dropped from 56mm above the surface)
	protected against 0.2 joules impact (equivalent to 0.25kg mass dropped from 80mm above the surface)
	protected against 0.35 joules impact (equivalent to 0.25kg mass dropped from 140mm above the surface)
	protected against 0.5 joules impact (equivalent to 0.25kg mass dropped from 200mm above the surface)
	protected against 0.7 joules impact (equivalent to 0.25kg mass dropped from 280mm above the surface)
	protected against 1 joules impact (equivalent to 0.25kg mass dropped from 400mm above the surface)
	protected against 2 joules impact (equivalent to 0.5kg mass dropped from 400mm above the surface)
	protected against 5 joules impact (equivalent to 1.7kg mass dropped from 300mm above the surface)
	protected against 10 joules impact (equivalent to 5.0kg mass dropped from 200mm above the surface)
	protected against 20 joules impact (equivalent to 5.0kg mass dropped from 400mm above the surface)