

D14MARK-MOD-SYS COMPONENTS SUSPENSION

D141318-

DESCRIPTION

Mark Suspension 250mm/9 13/16" x 220mm/98 11/16", 1 x 6W LED, 866lm, 350mA, CRI95, Without Canopy, Round Shape Abstract Glass

GENERAL

Series: Mark
 Subseries: Mark - Modular System
 Partner: Cangini & Tucci
 Division: Design
 Installation: Suspension
 Product Type: Pendant
 Mounting Location: Ceiling

PHYSICAL

Shape: Abstract
 Diameter (mm): 250
 Diameter (in): 9 13/16
 Height (mm): 220
 Height (in): 8 11/16
 Max. Overall Height (mm): 2220
 Max. Overall Height (in): 86 5/8
 Weight (kg): 1.20
 Weight (lbs): 2.65
 Fixture Finish: AMB / BLK / BRZ / GLD / GRN / PNK / RGD / RUB / SKB / SMK / STE / TOB / TRA
 Holder Finish: CHR / BCR / MWH / MBK
 Fixture Material: Glass / Metal
 Primary Material: Glass - Borosilicate
 Cable Details: 2000mm/78 3/4" Transparent Cable

ELECTRICAL

Input Wattage Range: 1 - 9 W
 Lamp Type: LED
 Input Wattage (W): 6
 Dimming: Tri-Mode (Non-Dimming and Phase Dimming (120Vac only) and 0-10V Dimming)
 Driver Included: Yes
 Driver Location: Integrated
 Driver Type: Constant Current - Universal
 Driver Class: Class 2
 Input Voltage (V): 120
 Constant Current (MA): 500mA

LED

Number of LEDs: 1
 Color Temperature (°K): 2700 / 3000
 Nominal Lumen (lm): 866
 CRI: >95 CRI
 Lamp Life (hrs): 50000

RATINGS AND CERTIFICATIONS

Certified By: Certified for North American Standards
 IP rating: IP20

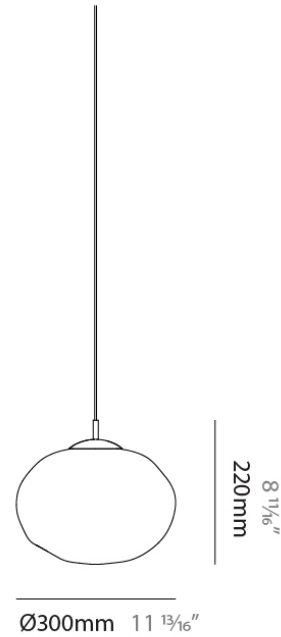

D14MARK-MOD-SYS COMPONENTS SUSPENSION

D141319-

DESCRIPTION

Mark Suspension 300mm/11 13/16" x 300mm/11 13/16", 1 x 8.4W LED, 1202lm, 350mA, CRI95, Without Canopy, Round Shape Abstract Glass

GENERAL

Series: Mark
 Subseries: Mark - Modular System
 Partner: Cangini & Tucci
 Division: Design
 Installation: Suspension
 Product Type: Pendant
 Mounting Location: Ceiling

PHYSICAL

Shape: Round
 Diameter (mm): 300
 Diameter (in): 11 13/16
 Height (mm): 300
 Height (in): 12 3/16
 Max. Overall Height (mm): 2300
 Max. Overall Height (in): 90 9/16
 Weight (kg): 1.50
 Weight (lbs): 3.31
 Diffuser: Glass
 Fixture Finish: AMB / BLK / BRZ / GLD / GRN / PNK / RGD / RUB / SKB / SMK / STE / TOB / TRA
 Holder Finish: CHR / BCR / MWH / MBK
 Fixture Material: Glass / Metal
 Primary Material: Glass - Borosilicate
 Cable Details: 2000mm/78 3/4" Transparent Cable

ELECTRICAL

Input Wattage Range: 1 - 9 W
 Lamp Type: LED
 Input Wattage (W): 8.4
 Dimming: Tri-Mode (Non-Dimming and Phase Dimming (120Vac only) and 0-10V Dimming)
 Driver Included: Yes
 Driver Location: Integrated
 Driver Type: Constant Current - Universal
 Driver Class: Class 2
 Input Voltage (V): 120
 Constant Current (MA): 350mA

LED

Number of LEDs: 1
 Color Temperature (°K): 2700 / 3000
 Nominal Lumen (lm): 1202
 CRI: >95 CRI
 Lamp Life (hrs): 50000

RATINGS AND CERTIFICATIONS

Certified By: Certified for North American Standards
 IP rating: IP20

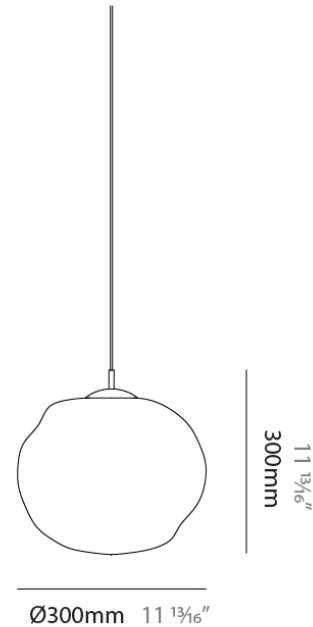

PROJECT
TYPE
NOTES
QUANTITY
DATE

D14MARK-MOD-SYS COMPONENTS SUSPENSION

D141320-

DESCRIPTION

Mark Suspension 250mm/9 13/16" x 190mm/7 1/2", 1 x 6W LED, 866lm, 350mA, CRI95, Without Canopy, Oval Shape Abstract Glass

GENERAL

Series: Mark
 Subseries: Mark - Modular System
 Partner: Cangini & Tucci
 Division: Design
 Installation: Suspension
 Product Type: Pendant
 Mounting Location: Ceiling

PHYSICAL

Shape: Oval
 Diameter (mm): 250
 Diameter (in): 9 13/16
 Height (mm): 190
 Height (in): 7 1/2
 Max. Overall Height (mm): 2190
 Max. Overall Height (in): 8 1/4
 Weight (kg): 1.20
 Weight (lbs): 2.65
 Diffuser: Glass
 Fixture Finish: AMB / BLK / BRZ / GLD / GRN / PNK / RGD / RUB / SKB / SMK / STE / TOB / TRA
 Holder Finish: CHR / BCR / MWH / MBK
 Fixture Material: Glass / Metal
 Primary Material: Glass - Borosilicate
 Cable Details: 2000mm/78 3/4" Transparent Cable

ELECTRICAL

Input Wattage Range: 1 - 9 W
 Lamp Type: LED
 Input Wattage (W): 6
 Dimming: Tri-Mode (Non-Dimming and Phase Dimming (120Vac only) and 0-10V Dimming)
 Driver Included: Yes
 Driver Location: Integrated
 Driver Type: Constant Current - Universal
 Driver Class: Class 2
 Input Voltage (V): 120
 Constant Current (mA): 500mA

LED

Number of LEDs: 1
 Color Temperature (°K): 2700 / 3000
 Nominal Lumen (lm): 866
 CRI: >95 CRI
 Lamp Life (hrs): 50000

RATINGS AND CERTIFICATIONS

Certified By: Certified for North American Standards
 IP rating: IP20

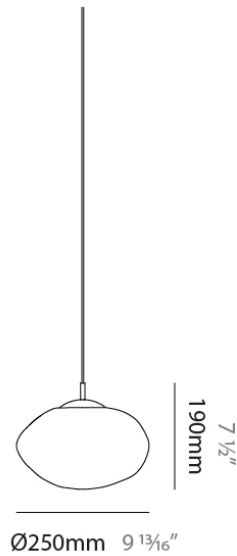

PROJECT	
TYPE	
NOTES	
QUANTITY	
DATE	

D14MARK-MOD-SYS COMPONENTS SUSPENSION

D141321-

DESCRIPTION

Mark Suspension 300mm/11 13/16" x 240mm/9 7/16", 1 x 8.4W LED, 1202lm, 350mA, CRI95, Without Canopy, Oval Shape Abstract Glass

GENERAL

Series: Mark
 Subseries: Mark - Modular System
 Partner: Cangini & Tucci
 Division: Design
 Installation: Suspension
 Product Type: Pendant
 Mounting Location: Ceiling

PHYSICAL

Shape: Oval
 Diameter (mm): 300
 Diameter (in): 11 13/16
 Height (mm): 240
 Height (in): 9 7/16
 Max. Overall Height (mm): 2240
 Max. Overall Height (in): 88 3/16
 Weight (kg): 1.50
 Weight (lbs): 3.31
 Diffuser: Glass
 Fixture Finish: AMB / BLK / BRZ / GLD / GRN / PNK / RGD / RUB / SKB / SMK / STE / TOB / TRA
 Holder Finish: CHR / BCR / MWH / MBK
 Fixture Material: Glass / Metal
 Primary Material: Glass - Borosilicate
 Cable Details: 2000mm/78 3/4" Transparent Cable

ELECTRICAL

Input Wattage Range: 1 - 9 W
 Lamp Type: LED
 Input Wattage (W): 8.4
 Dimming: Tri-Mode (Non-Dimming and Phase Dimming (120Vac only) and 0-10V Dimming)
 Driver Included: Yes
 Driver Location: Integrated
 Driver Type: Constant Current - Universal
 Driver Class: Class 2
 Input Voltage (V): 120
 Constant Current (MA): 350mA

LED

Number of LEDs: 1
 Color Temperature (°K): 2700 / 3000
 Nominal Lumen (lm): 1202
 CRI: >95 CRI
 Lamp Life (hrs): 50000

RATINGS AND CERTIFICATIONS

Certified By: Certified for North American Standards
 IP rating: IP20

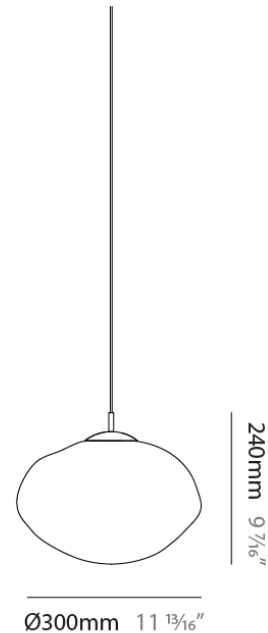

PROJECT
TYPE
NOTES
QUANTITY
DATE

D14MARK-MOD-SYS COMPONENTS SUSPENSION

D141322-

DESCRIPTION

Mark Suspension 300mm/11 13/16" x 180mm/7 1/16", 1 x 6W LED, 866lm, 350mA, CRI95, Without Canopy, Disk Shape Abstract Glass

GENERAL

Series: Mark
 Subseries: Mark - Modular System
 Partner: Cangini & Tucci
 Division: Design
 Installation: Suspension
 Product Type: Pendant
 Mounting Location: Ceiling

PHYSICAL

Shape: Oval
 Diameter (mm): 300
 Diameter (in): 11 13/16
 Height (mm): 180
 Height (in): 7 1/16
 Max. Overall Height (mm): 2180
 Max. Overall Height (in): 85 13/16
 Weight (kg): 1.20
 Weight (lbs): 2.65
 Diffuser: Glass
 Fixture Finish: AMB / BLK / BRZ / GLD / GRN / PNK / RGD / RUB / SKB / SMK / STE / TOB / TRA
 Holder Finish: CHR / BCR / MWH / MBK
 Fixture Material: Glass / Metal
 Primary Material: Glass - Borosilicate
 Cable Details: 2000mm/78 3/4" Transparent Cable

ELECTRICAL

Input Wattage Range: 1 - 9 W
 Lamp Type: LED
 Input Wattage (W): 6
 Dimming: Tri-Mode (Non-Dimming and Phase Dimming (120Vac only) and 0-10V Dimming)
 Driver Included: Yes
 Driver Location: Integrated
 Driver Type: Constant Current - Universal
 Driver Class: Class 2
 Input Voltage (V): 120
 Constant Current (MA): 500mA

LED

Number of LEDs: 1
 Color Temperature (°K): 2700 / 3000
 Nominal Lumen (lm): 866
 CRI: >95 CRI
 Lamp Life (hrs): 50000

RATINGS AND CERTIFICATIONS

Certified By: Certified for North American Standards
 IP rating: IP20

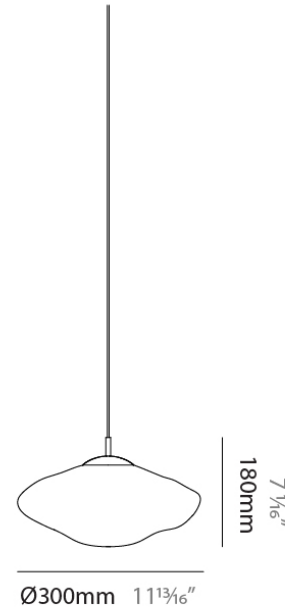

PROJECT	
TYPE	
NOTES	
QUANTITY	
DATE	

D14MARK-MOD-SYS COMPONENTS SUSPENSION

D141323-

DESCRIPTION

Mark Suspension 350mm/13 3/4" x 200mm/7 7/8", 1 x 8.4W LED, 1202lm, 350mA, CRI95, Without Canopy, Disk Shape Abstract Glass

GENERAL

Series: Mark
 Subseries: Mark - Modular System
 Partner: Cangini & Tucci
 Division: Design
 Installation: Suspension
 Product Type: Pendant
 Mounting Location: Ceiling

PHYSICAL

Shape: Oval
 Diameter (mm): 350
 Diameter (in): 13 3/4
 Height (mm): 200
 Height (in): 7 7/8
 Max. Overall Height (mm): 2200
 Max. Overall Height (in): 86 5/8
 Weight (kg): 1.50
 Weight (lbs): 3.31
 Diffuser: Glass
 Fixture Finish: AMB / BLK / BRZ / GLD / GRN / PNK / RGD / RUB / SKB / SMK / STE / TOB / TRA
 Holder Finish: CHR / BCR / MWH / MBK
 Fixture Material: Glass / Metal
 Primary Material: Glass - Borosilicate

ELECTRICAL

Input Wattage Range: 1 - 9 W
 Lamp Type: LED
 Input Wattage (W): 8.4
 Dimming: Tri-Mode (Non-Dimming and Phase Dimming (120Vac only) and 0-10V Dimming)
 Driver Included: Yes
 Driver Location: Integrated
 Driver Type: Constant Current - Universal
 Driver Class: Class 2
 Input Voltage (V): 120
 Constant Current (MA): 350mA

LED

Number of LEDs: 1
 Color Temperature (°K): 2700 / 3000
 Nominal Lumen (lm): 1202
 CRI: >95 CRI
 Lamp Life (hrs): 50000

RATINGS AND CERTIFICATIONS

Certified By: Certified for North American Standards
 IP rating: IP20

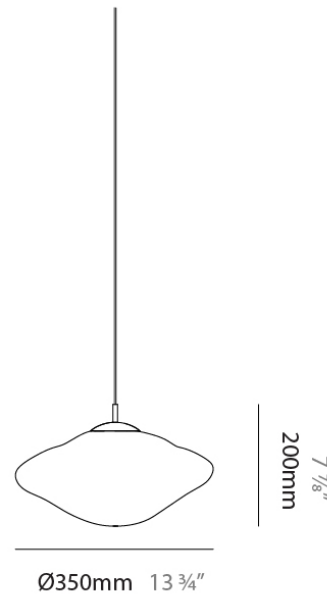

D14MARK-MOD-SYS COMPONENTS

D149000-

DESCRIPTION

Standard Single 120mm - Round Canopy

GENERAL

Partner: Cangini & Tucci

Division: Design

PHYSICAL

Shape: Round

Diameter (mm): 120

Diameter (in): 4 ³/₄

Height (mm): 30

Height (in): 1 ³/₁₆

Fixture Finish: CHR / BCR / MBK / MWH

Fixture Material: Metal

RATINGS AND CERTIFICATIONS

Certified By: Certified for North American Standards

IP rating: IP20

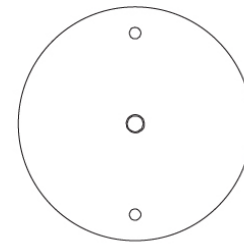
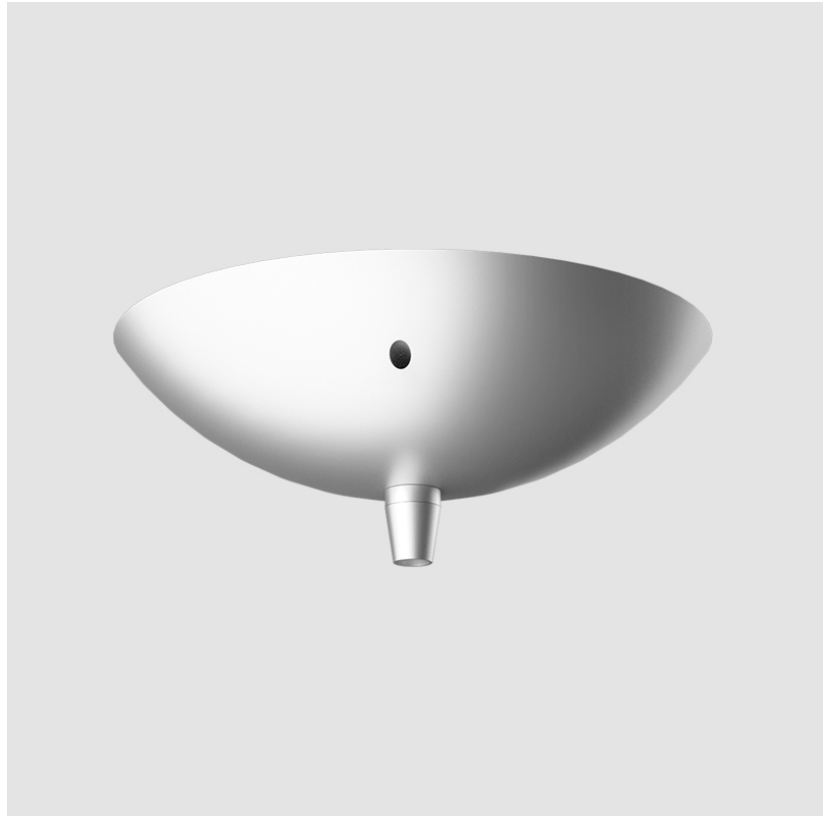

Ø120mm 4 ³/₄"

1 ³/₁₆"
30mm

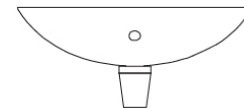

D14MARK-MOD-SYS COMPONENTS

D149001-

DESCRIPTION

Single 120mm - Round Canopy

GENERAL

Partner: Cangini & Tucci

Division: Design

PHYSICAL

Shape: Round

Diameter (mm): 120

Diameter (in): 4 ¾

Height (mm): 30

Height (in): 1 ⅜

Fixture Finish: CHR / BCR / MBK / MWH

Fixture Material: Metal

RATINGS AND CERTIFICATIONS

Certified By: Certified for North American Standards

IP rating: IP20

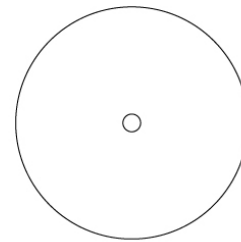

Ø120mm 4 ¾"

1 ⅜"
30mm

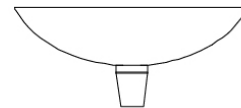

D14MARK-MOD-SYS COMPONENTS

D149004-

DESCRIPTION

Recessed Round 45mm Canopy

GENERAL

Partner: Cangini & Tucci

Division: Design

PHYSICAL

Shape: Round

Diameter (mm): 45

Diameter (in): 1 3/4

Fixture Finish: CHR / BCR / MBK / MWH

Fixture Material: Metal

RATINGS AND CERTIFICATIONS

Certified By: Certified for North American Standards

IP rating: IP20

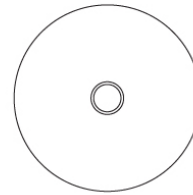

Ø45mm 1 3/4"

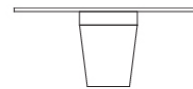

D14MARK-MOD-SYS COMPONENTS

D149006-

DESCRIPTION

Round Canopy - 95mm - 3 Holes

GENERAL

Partner: Cangini & Tucci

Division: Design

PHYSICAL

Shape: Round

Diameter (mm): 120

Diameter (in): 4 ¾

Height (mm): 25

Height (in): 1

Fixture Finish: CHR / BCR / MBK / MWH

Fixture Material: Metal

RATINGS AND CERTIFICATIONS

Certified By: Certified for North American Standards

IP rating: IP20

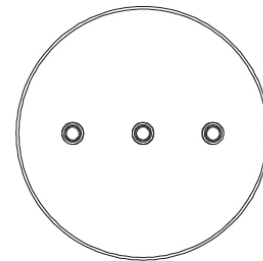

Ø120mm 4 ¾"

1"
25mm



D14MARK-MOD-SYS COMPONENTS

D149007-

DESCRIPTION

Round Canopy - 120mm - 5 Holes

GENERAL

Partner: Cangini & Tucci

Division: Design

PHYSICAL

Shape: Round

Diameter (mm): 120

Diameter (in): 4 ¾

Height (mm): 25

Height (in): 1

Fixture Finish: CHR / BCR / MBK / MWH

Fixture Material: Metal

RATINGS AND CERTIFICATIONS

Certified By: Certified for North American Standards

IP rating: IP20

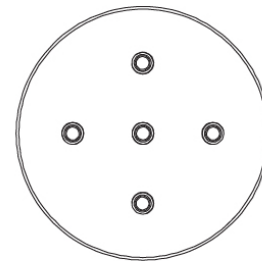

Ø120mm 4 ¾"

1"
25mm



D14MARK-MOD-SYS COMPONENTS

D149008-

DESCRIPTION

Single 120mm - Round Cone Canopy - 2 External Holes + 1 Central Hole

GENERAL

Partner: Cangini & Tucci

Division: Design

PHYSICAL

Shape: Round

Diameter (mm): 120

Diameter (in): 4 ¾

Height (mm): 70

Height (in): 2 ¾

Fixture Finish: CHR / BCR / MBK / MWH

Fixture Material: Metal

RATINGS AND CERTIFICATIONS

Certified By: Certified for North American Standards

IP rating: IP20

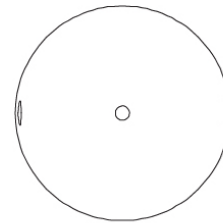
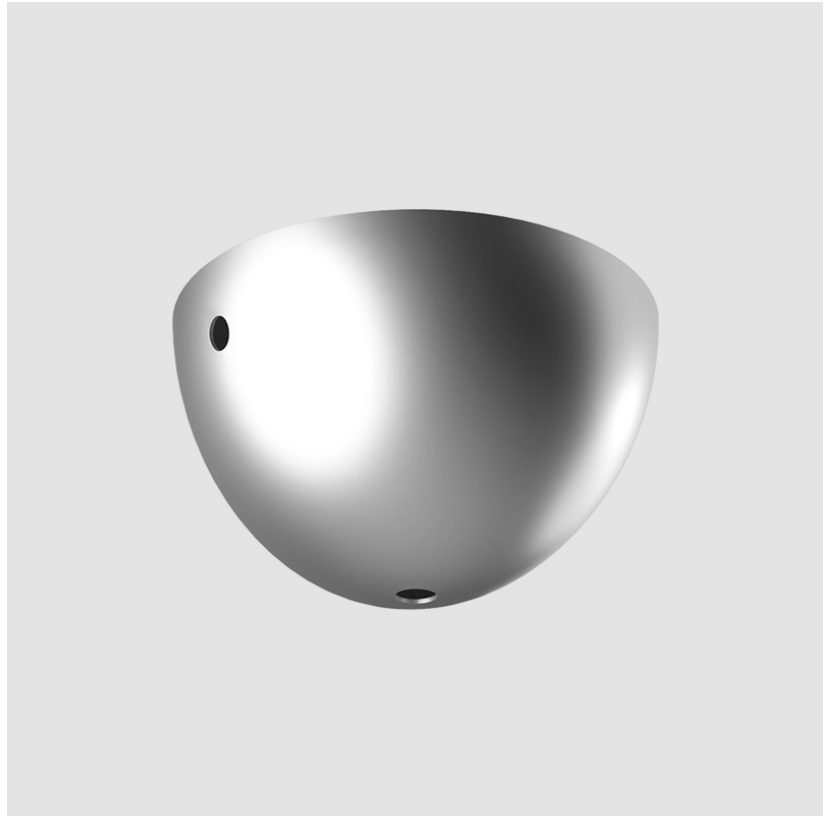

Ø120mm 4 ¾"

70mm 2 ¾"

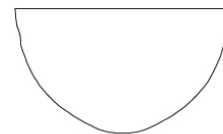

D14MARK-MOD-SYS COMPONENTS

D149009-

DESCRIPTION

Single 120mm - Round Cone Canopy - 4 External Holes + 1 Central Hole

GENERAL

Partner: Cangini & Tucci

Division: Design

PHYSICAL

Shape: Round

Diameter (mm): 120

Diameter (in): 4 ³/₄

Height (mm): 90

Height (in): 3 ⁹/₁₆

Fixture Finish: CHR / BCR / MBK / MWH

Fixture Material: Metal

RATINGS AND CERTIFICATIONS

Certified By: Certified for North American Standards

IP rating: IP20

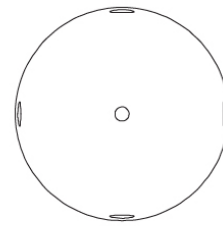

Ø120mm 4 ³/₄"

90mm 3 ⁹/₁₆"

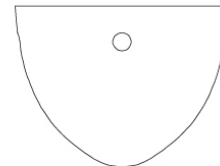

D14MARK-MOD-SYS COMPONENTS

D149011-

DESCRIPTION

Flute - Cable Spacer

GENERAL

Series: Flute _____
 Partner: Cangini & Tucci _____
 Division: Design _____

PHYSICAL

Fixture Finish: CHR / BCR / MBK / MWH _____
 Fixture Material: Metal _____

RATINGS AND CERTIFICATIONS

Certified By: Certified for North American Standards _____
 IP rating: IP20 _____

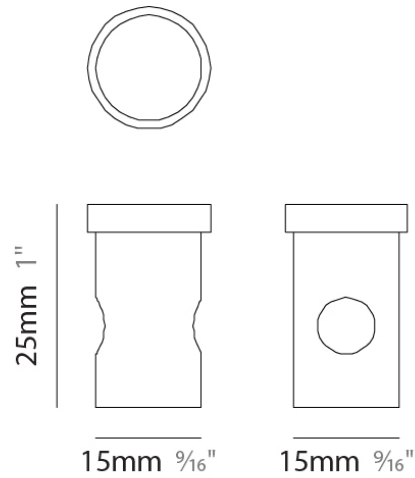

D14MARK-MOD-SYS COMPONENTS

D149012-

DESCRIPTION
 Accessory - Wall Stud Cable Spacer

GENERAL
 Series: Flute
 Partner: Cangini & Tucci
 Division: Design

PHYSICAL
 Fixture Finish: CHR / BCR / MBK / MWH
 Fixture Material: Metal

RATINGS AND CERTIFICATIONS
 Certified By: Certified for North American Standards
 IP rating: IP20

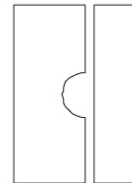
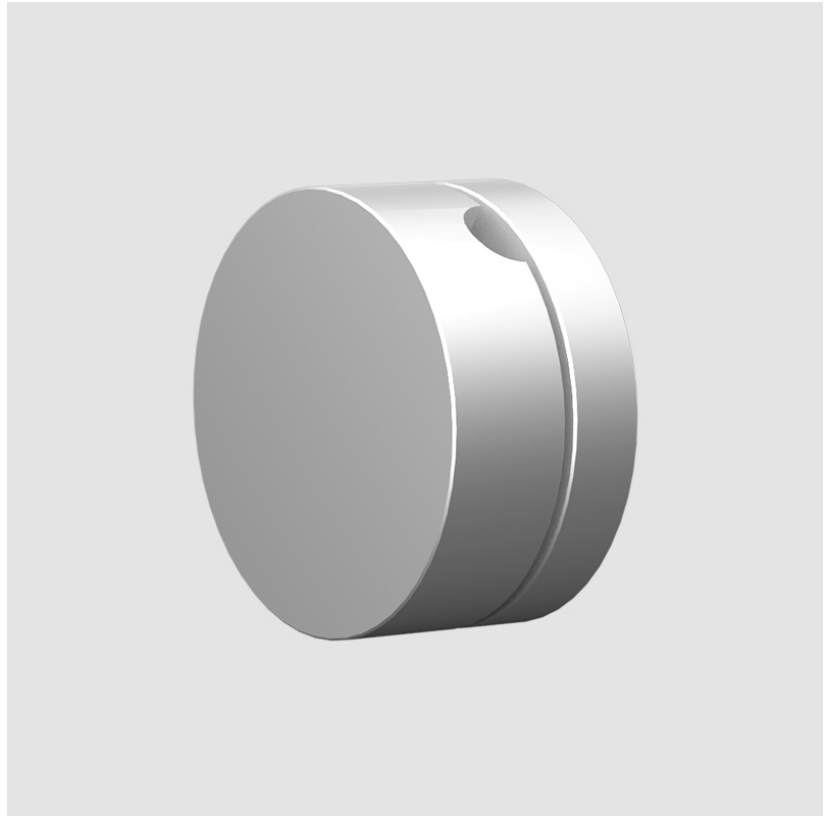

20mm ¹³/₁₆"



10mm ³/₈"

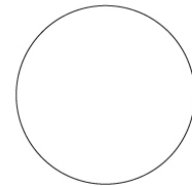

20mm ¹³/₁₆"



PROJECT	
TYPE	
NOTES	
QUANTITY	
DATE	

D14MARK-MOD-SYS COMPONENTS

D149013-

DESCRIPTION

Accessory - Ceiling Cable Spacer

GENERAL

Series: Flute

Partner: Cangini & Tucci

Division: Design

PHYSICAL

Fixture Finish: CHR / BCR / MBK / MWH

Fixture Material: Metal

RATINGS AND CERTIFICATIONS

Certified By: Certified for North American Standards

IP rating: IP20

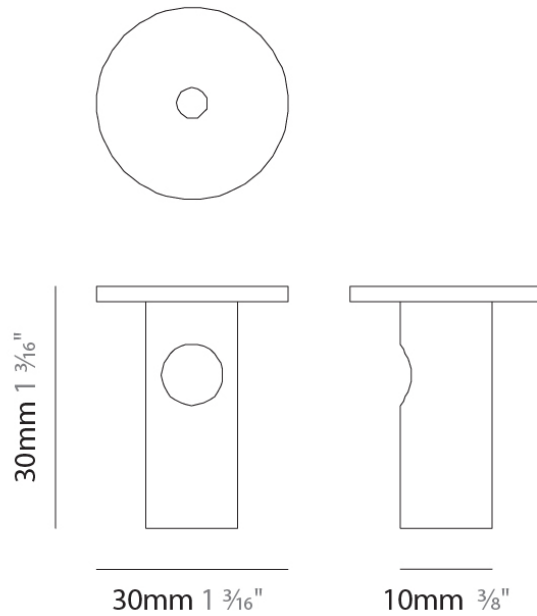

PROJECT	
TYPE	
NOTES	
QUANTITY	
DATE	

D14MARK-MOD-SYS COMPONENTS

D149014-

DESCRIPTION
 Round Canopy - 270mm - for 3 - 5 - 6 lights

GENERAL
 Partner: Cangini & Tucci
 Division: Design

PHYSICAL
 Shape: Round
 Diameter (mm): 270
 Diameter (in): 10 ⁵/₈
 Height (mm): 30
 Height (in): 1 ³/₁₆
 Fixture Finish: CHR / BCR / MBK / MWH
 Fixture Material: Metal

RATINGS AND CERTIFICATIONS
 Certified By: Certified for North American Standards
 IP rating: IP20

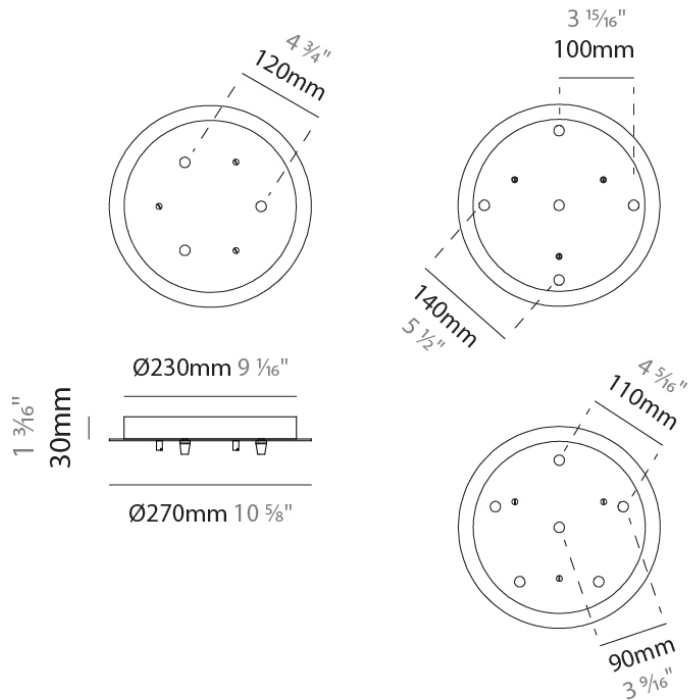

PROJECT	
TYPE	
NOTES	
QUANTITY	
DATE	

D14MARK-MOD-SYS COMPONENTS

D149015-

DESCRIPTION
 Round Canopy - 430mm - for 3 - 5 - 6 - 7 - 8 - 9 - 10 -11 lights

GENERAL
 Partner: Cangini & Tucci
 Division: Design

PHYSICAL
 Shape: Round
 Diameter (mm): 430
 Diameter (in): 16 ¹⁵/₁₆
 Height (mm): 40
 Height (in): 1 ⁹/₁₆
 Fixture Finish: CHR / BCR / MBK / MWH
 Fixture Material: Metal

RATINGS AND CERTIFICATIONS
 Certified By: Certified for North American Standards
 IP rating: IP20

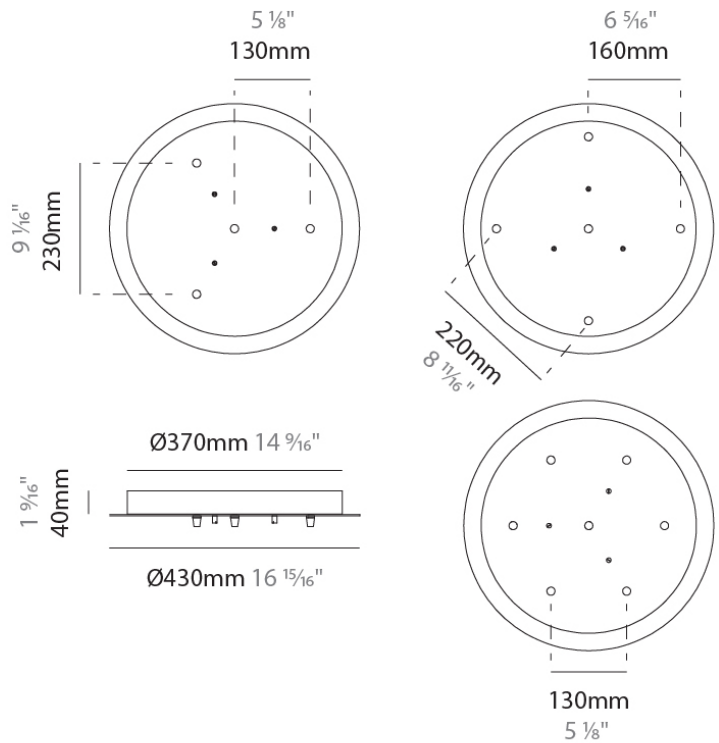

PROJECT	
TYPE	
NOTES	
QUANTITY	
DATE	

D14MARK-MOD-SYS COMPONENTS

D149016-

DESCRIPTION

Round Canopy - 500mm - for 3 - 4 - 5 lights

GENERAL

Partner: Cangini & Tucci

Division: Design

PHYSICAL

Shape: Round

Diameter (mm): 500

Diameter (in): 19 ¹¹/₁₆"

Height (mm): 40

Height (in): 1 ⁹/₁₆"

Fixture Finish: CHR / BCR / MBK / MWH

Fixture Material: Metal

RATINGS AND CERTIFICATIONS

Certified By: Certified for North American Standards

IP rating: IP20

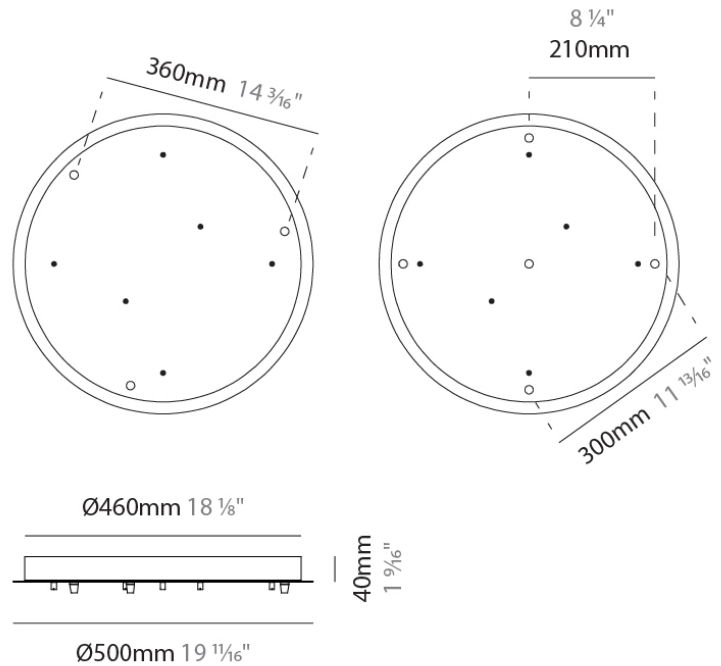

D14MARK-MOD-SYS COMPONENTS

PROJECT	
TYPE	
NOTES	
QUANTITY	
DATE	

D149017-

DESCRIPTION
 Square Canopy - 300mm - for 5 lights

GENERAL
 Partner: Cangini & Tucci
 Division: Design

PHYSICAL
 Shape: Square
 Length (mm): 300
 Length (in): 11 ¹³/₁₆"
 Width (mm): 300
 Width (in): 11 ¹³/₁₆"
 Height (mm): 30
 Height (in): 1 ³/₁₆"
 Fixture Finish: CHR / BCR / MBK / MWH
 Fixture Material: Metal

RATINGS AND CERTIFICATIONS
 Certified By: Certified for North American Standards
 IP rating: IP20

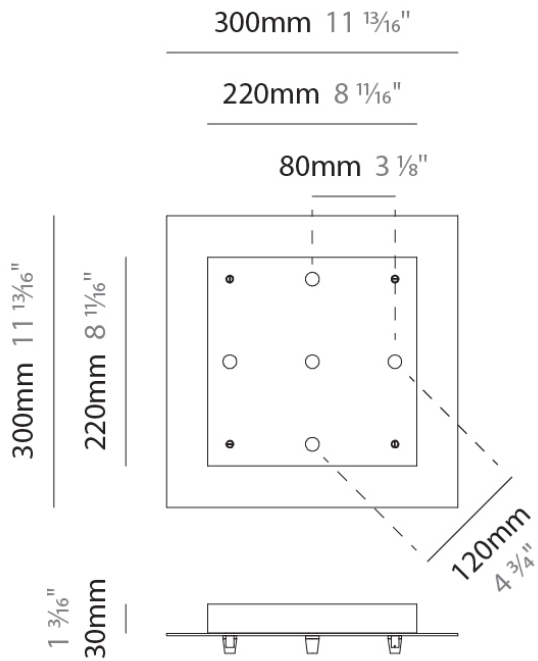

D14MARK-MOD-SYS COMPONENTS

PROJECT	
TYPE	
NOTES	
QUANTITY	
DATE	

D149018-

DESCRIPTION
 Square Canopy - 400mm - for 5 lights

GENERAL
 Partner: Cangini & Tucci
 Division: Design

PHYSICAL
 Shape: Square
 Length (mm): 400
 Length (in): 15 3/4
 Width (mm): 400
 Width (in): 15 3/4
 Height (mm): 30
 Height (in): 1 3/16
 Fixture Finish: CHR / BCR / MBK / MWH
 Fixture Material: Metal

RATINGS AND CERTIFICATIONS
 Certified By: Certified for North American Standards
 IP rating: IP20

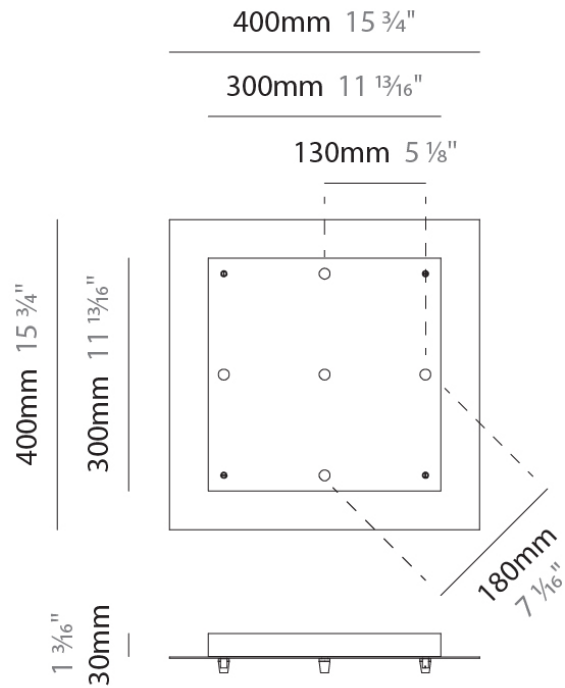

D14MARK-MOD-SYS COMPONENTS

PROJECT	
TYPE	
NOTES	
QUANTITY	
DATE	

D149019-

DESCRIPTION
Slim Linear Canopy - 300mm - 2 lights

GENERAL
Partner: Cangini & Tucci
Division: Design

PHYSICAL
Shape: Rectangle
Length (mm): 300
Length (in): 11 ¹³/₁₆"
Width (mm): 30
Width (in): 1 ³/₁₆"
Height (mm): 30
Height (in): 1 ³/₁₆"
Fixture Finish: CHR / BCR / MBK / MWH
Fixture Material: Metal

RATINGS AND CERTIFICATIONS
Certified By: Certified for North American Standards
IP rating: IP20

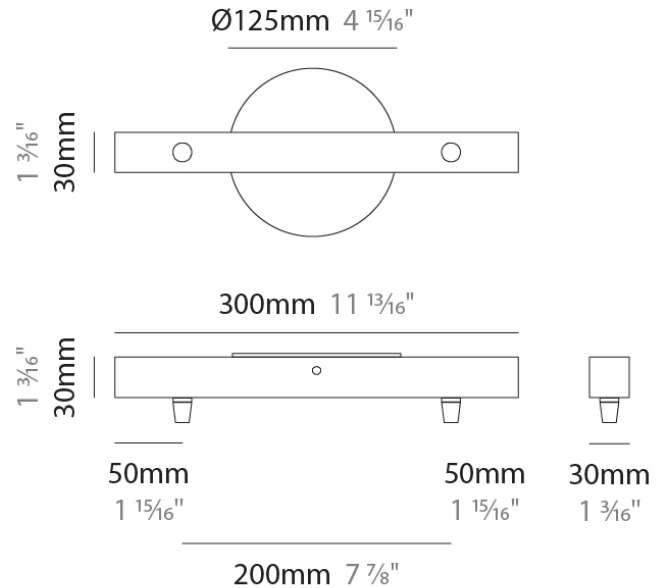

PROJECT	
TYPE	
NOTES	
QUANTITY	
DATE	

D14MARK-MOD-SYS COMPONENTS

D149020-

DESCRIPTION

Slim Linear Canopy - 500mm - 3 lights

GENERAL

Partner: Cangini & Tucci

Division: Design

PHYSICAL

Shape: Rectangle

Length (mm): 500

Length (in): 19 ¹¹/₁₆"

Width (mm): 30

Width (in): 1 ³/₁₆"

Height (mm): 30

Height (in): 1 ³/₁₆"

Fixture Finish: CHR / BCR / MBK / MWH

Fixture Material: Metal

RATINGS AND CERTIFICATIONS

Certified By: Certified for North American Standards

IP rating: IP20

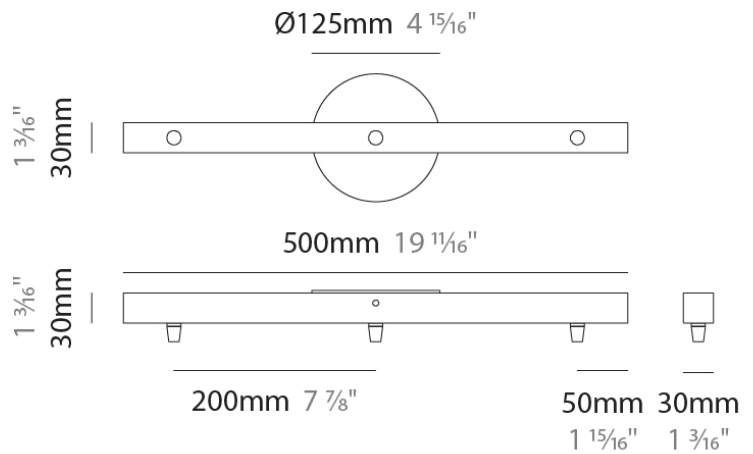

D14MARK-MOD-SYS COMPONENTS

LEGEND

	floor-mounted		pivotal		special LED (upon request) RGB, RGBW, tunable, gold+, meat+, art+, fashion+
	wall and ceiling: recessed and surface mounted		rotating		warm dim / natural dimming LED
	ceiling-mounted and wall-mounted		illuminate tilted		rechargeable battery powered
	wall-mounted		color of suspension cable		fixture with natural vivid LED (upon request)
	omni-directional light distribution		length of suspension cable		color rendering index
	direct light distribution		reflector degree selection		color temperature
	direct/indirect light distribution		super spot		lumen (luminous flux)
	indirect light distribution		lens		efficacy (lumens per watt)
	asymmetric light distribution		lens pack		Unified Glare Rating (UGR) range from 5-40
	aura light distribution		shine ring		marine grade (AISI 316 stainless steel)
	round wall or ceiling cut-out		integrated shine ring with diffuser		walk on
	square wall or ceiling cut-out		free individual colors 01-29		drive on
	the supplied jig specifies the cutout dimensions		individual colors: 00 (free of charge), 01-25 (extra charge)		Dark Sky Compliance
	minimum distance (meters) lamp - object		luminaire part to be colored (F1)		Americans with Disabilities Act (less than 4" off the wall located between 27"-84" from floor)
	recessed depth		luminaire part to be colored (F2)		lamp protected against explosion
	ceiling thickness in mm		luminaire part to be colored (F3)		blown glass using traditional methods by master glass blower
	ceiling thickness selection		luminaire part to be colored (F4)		acoustic material
	dimnable DP (phase), DV (0-10V), DD (dali), DS (step-dim)		luminaire part to be colored (F5)		protection class I, protection insulation
	included or excluded LED driver/transformer/control gear		color of 3-circuit adaptor		protection class II, protection insulation
	separately switchable		indirect diffuser		ETL Certified to UL and CSA Standards
	sensor		direct diffuser		UL Certified to UL and CSA Standards
	remote control		ball-proof (upon request)		CSA Certified to UL and CSA Standards
	available upon request		accessory		Certified for North American Standards

IP RATING

	protected against ingress of solid bodies greater than 12.5mm (finger)
	protected against ingress of solid bodies greater than 2.5mm protected against sprays of water up to 60 degrees from the vertical (rain)
	protected against ingress of solid bodies greater than 1mm (wire) no protection against the ingress of moisture
	protected against ingress of solid bodies greater than 1mm (wire) protected against sprays of water up to 60 degrees from the vertical (rain)
	protected against ingress of solid bodies greater than 1mm (wire) protected against water splashed from all directions
	protected against limited ingress of dust (wet rooms/covered outdoor areas) protected against water splashed from all directions
	protected against ingress of dust protected against jets of water
	protected against ingress of dust protected against powerful jets of water or heavy seas
	protected against ingress of dust protected against immersion of water between 15cm - 1m for 30 minutes
	protected against ingress of dust protected against immersion of water under pressure for long periods

IK RATING

	protected against 0.14 joules impact (equivalent to 0.25kg mass dropped from 56mm above the surface)
	protected against 0.2 joules impact (equivalent to 0.25kg mass dropped from 80mm above the surface)
	protected against 0.35 joules impact (equivalent to 0.25kg mass dropped from 140mm above the surface)
	protected against 0.5 joules impact (equivalent to 0.25kg mass dropped from 200mm above the surface)
	protected against 0.7 joules impact (equivalent to 0.25kg mass dropped from 280mm above the surface)
	protected against 1 joules impact (equivalent to 0.25kg mass dropped from 400mm above the surface)
	protected against 2 joules impact (equivalent to 0.5kg mass dropped from 400mm above the surface)
	protected against 5 joules impact (equivalent to 1.7kg mass dropped from 300mm above the surface)
	protected against 10 joules impact (equivalent to 5.0kg mass dropped from 200mm above the surface)
	protected against 20 joules impact (equivalent to 5.0kg mass dropped from 400mm above the surface)