

E12I0012- COMPONENTS

DND0120024HY

DESCRIPTION

Hatch - LV12-24N-UNV-Y - Non-dimming - 12W - 24Vdc - 120-277Vac - LED power supply -Used with ENCP4 -Available with IP68-Outdoor Rated -ENCP20, ENCP22

GENERAL

Division: Architectural : Components : LED Drivers

PHYSICAL

Length (mm): 75.9

Length (in): 3

Width (mm): 31.2

Width (in): 1 ⁷/₃₂

Height (mm): 24

Height (in): 1

Fixture Material: Plastic

ELECTRICAL

Lamp Type: LED

Input Wattage (W): 16

Total Output Wattage (W): 4.32-12

Dimming: Non-Dimmable

Driver Type: Constant Voltage - Universal

Driver Class: Class 2

Input Voltage (V): 120 - 277

Output Voltage (V): 24

RATINGS AND CERTIFICATIONS

Certified By: UR Listed

IP rating: Dry / Damp

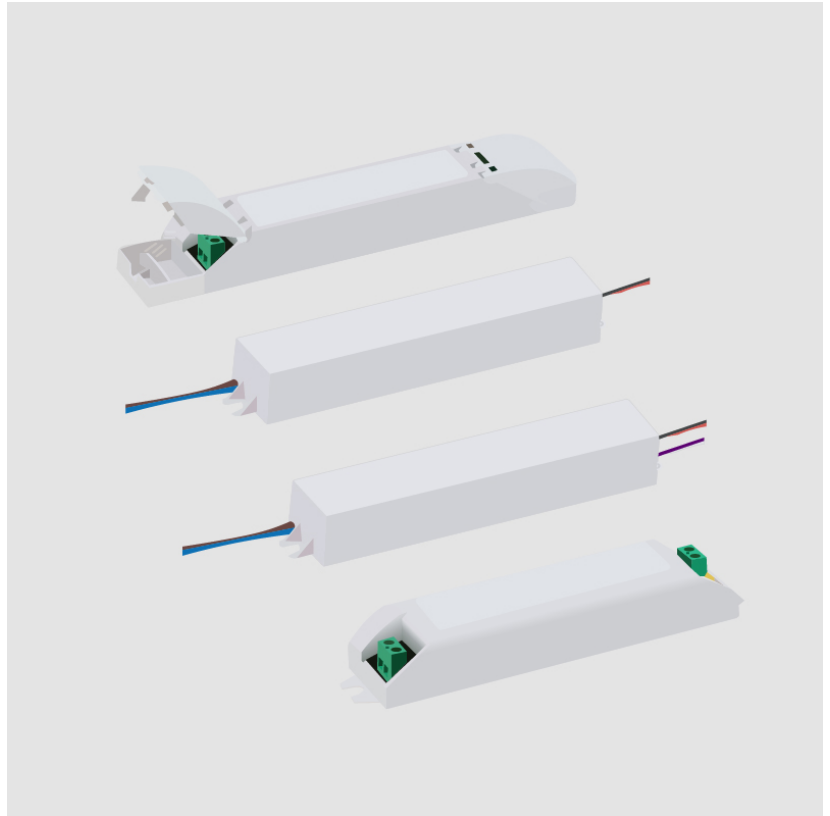

E12I0012- COMPONENTS

DPH0300024EL

DESCRIPTION

EMCOD - MLE30-24DC - Phase dimming (LE / TE) @120Vac only - 1.2-30W - 24Vdc - 120-277Vac - (Outdoor) LED power supply w/UL approved enclosure

GENERAL

Division: Architectural : Components : LED Drivers

PHYSICAL

Length (mm): 165.1

Length (in): 6 1/2

Width (mm): 91.95

Width (in): 3 5/8

Height (mm): 25.9

Height (in): 1

Weight (kg): 0.09

Weight (lbs): 0.21

Fixture Material: Metal

ELECTRICAL

Lamp Type: LED

Total Output Wattage (W): 1.5-30

Dimming: Phase Dimming (120Vac Only)

Driver Type: Constant Voltage - Universal

Driver Class: Class 2

Input Voltage (V): 120 - 277

Output Voltage (V): 24

LED

Efficiency (%): 90

RATINGS AND CERTIFICATIONS

Certified By: UL Listed

IP rating: Dry / Damp

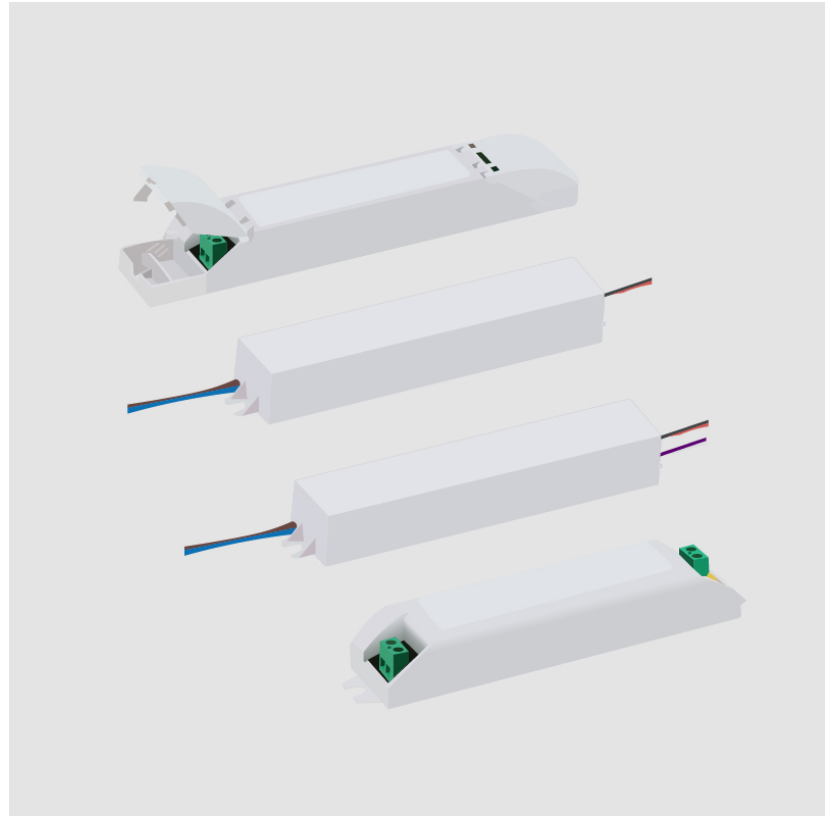

PROJECT
TYPE
NOTES
QUANTITY
DATE

E12I0012- COMPONENTS

DVO0160024MF

DESCRIPTION

MeanWell - LPF-16D-24 - 1-10Vdc / Resistance / 10V PWM
Dimming - 5.28-16.08W - 24Vdc - 120-277Vac - LED power supply
-Used with ENCP5 -Available with IP68-Outdoor Rated -ENCP20,
ENCP22

GENERAL

Division: Architectural

PHYSICAL

Length (mm): 151

Length (in): 5 ¹⁵/₁₆

Width (mm): 40

Width (in): 1 ³⁷/₆₄

Height (mm): 32

Height (in): 1 ¹⁷/₆₄

Weight (kg): 0.21

Weight (lbs): 0.46

Fixture Material: Plastic

ELECTRICAL

Lamp Type: LED

Input Wattage (W): 18

Total Output Wattage (W): 5.28- 16.08

Dimming: 1-10V Dimming to 10%

Driver Type: Constant Voltage - Universal

Driver Class: Class 2

Input Voltage (V): 120 - 277

Output Voltage (V): 24

Constant Voltage (V): 13.2-24

RATINGS AND CERTIFICATIONS

Certified By: UR Listed

IP rating: IP30

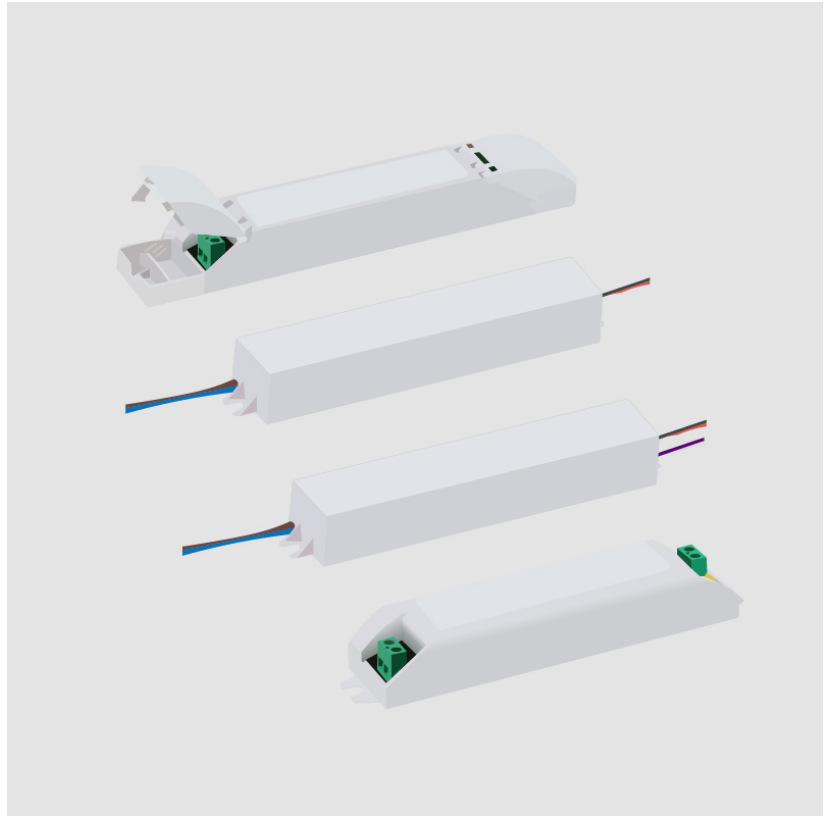

E12I0012- COMPONENTS

PROJECT
TYPE
NOTES
QUANTITY
DATE

E12A0027

DESCRIPTION
 Caliber 80 - Wall - Fixing springs

GENERAL
 Series: Caliber
 Brand: Unonovesette
 Division: Exterior

RATINGS AND CERTIFICATIONS
 Certified By: Certified for North American Standards
 IP rating: IP68

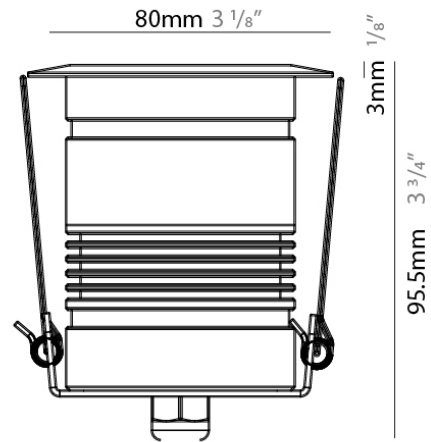

E12I0012- COMPONENTS

E12A0028

DESCRIPTION

Caliber 80 - Housing box

GENERAL

Series: Caliber

Subseries: Caliber 80

Brand: Unonovesette

Division: Exterior

PHYSICAL

Diameter (mm): 75

Diameter (in): $2 \frac{15}{16}$

Height (mm): 120

Height (in): $4 \frac{3}{4}$

Fixture Material: Plastic

RATINGS AND CERTIFICATIONS

Certified By: Certified for North American Standards

IP rating: IP68

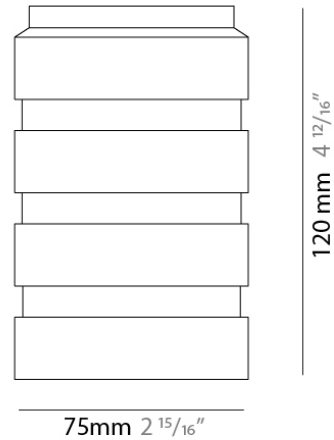

PROJECT	_____
TYPE	_____
NOTES	_____
QUANTITY	_____
DATE	_____

E12I0012- COMPONENTS

E12A0074

DESCRIPTION

0/1-10V dimmer fader sequencer - input 12/24/48Vdc - 1 ch. - Constant Voltage (Required for 0-10V dimming. To be used with Non Dimming Driver)

GENERAL

Brand: Unonovesette

Division: Exterior

PHYSICAL

Length (mm): 58

Length (in): 2 ⁵/₁₆

Width (mm): 45

Width (in): 1 ³/₄

Height (mm): 25

Height (in): 1

Fixture Material: Plastic

RATINGS AND CERTIFICATIONS

Certified By: Certified for North American Standards

IP rating: IP68

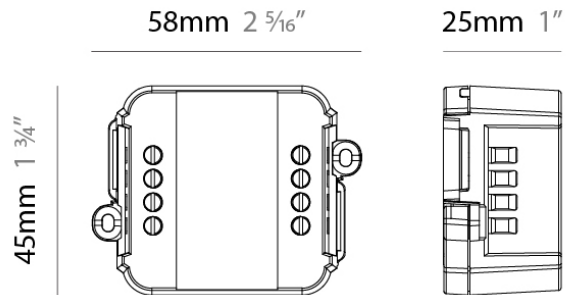

E12I0012- COMPONENTS

E12A0075

DESCRIPTION

DALI dimmer fader sequencer input - 12/24/48Vdc 1 ch. constant voltage (Required for DALI dimming. To be used with Non Dimming Driver)

GENERAL

Brand: Unonovesette

Division: Exterior

RATINGS AND CERTIFICATIONS

Certified By: Certified for North American Standards

IP rating: IP68

PROJECT

TYPE

NOTES

QUANTITY

DATE



E12I0012- COMPONENTS

E12A0076

DESCRIPTION

DALI dimmer fader sequencer input - 12/24/48Vdc 1 ch. constant voltage - IP67 (Required for DALI dimming. To be used with Non Dimming Driver)

GENERAL

Brand: Unonovesette

Division: Exterior

RATINGS AND CERTIFICATIONS

Certified By: Certified for North American Standards

IP rating: IP68

PROJECT

TYPE

NOTES

QUANTITY

DATE



E12I0012- COMPONENTS

PROJECT	
TYPE	
NOTES	
QUANTITY	
DATE	

ENCP4

DESCRIPTION

Empty Metal Enclosure for Driver - IP20 - Indoor Rated

GENERAL

Division: Architectural

PHYSICAL

Shape: Rectangle

Length (mm): 92

Length (in): 3 ⁵/₈

Width (mm): 68

Width (in): 2 ¹¹/₁₆

Height (mm): 40

Height (in): 1 ⁹/₁₆

Screws: A4 stainless steel

Fixture Material: Metal

RATINGS AND CERTIFICATIONS

IP rating: IP20

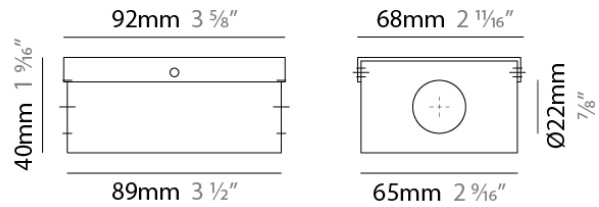

E12I0012- COMPONENTS

PROJECT
TYPE
NOTES
QUANTITY
DATE

ENCP9

DESCRIPTION

Empty Metal Enclosure for Driver - IP20 - Indoor Rated

GENERAL

Division: Architectural : Components

PHYSICAL

Shape: Rectangle

Length (mm): 280

Length (in): 11

Width (mm): 58

Width (in): 2 ⁵/₁₆

Height (mm): 54

Height (in): 2 ¹/₈

Screws: A4 stainless steel

Fixture Material: Metal

RATINGS AND CERTIFICATIONS

IP rating: IP20

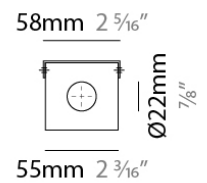
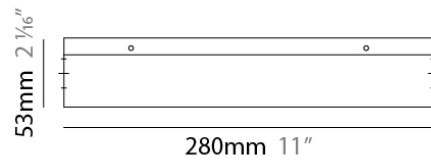

LEGEND

	floor-mounted		pivotal		special LED (upon request) RGB, RGBW, tunable, gold+, meat+, art+, fashion+
	wall and ceiling: recessed and surface mounted		rotating		warm dim / natural dimming LED
	ceiling-mounted and wall-mounted		illuminate tilted		rechargeable battery powered
	wall-mounted		color of suspension cable		fixture with natural vivid LED (upon request)
	omni-directional light distribution		length of suspension cable		color rendering index
	direct light distribution		reflector degree selection		color temperature
	direct/indirect light distribution		super spot		lumen (luminous flux)
	indirect light distribution		lens		efficacy (lumens per watt)
	asymmetric light distribution		lens pack		Unified Glare Rating (UGR) range from 5-40
	aura light distribution		shine ring		marine grade (AISI 316 stainless steel)
	round wall or ceiling cut-out		integrated shine ring with diffuser		walk on
	square wall or ceiling cut-out		free individual colors 01-29		drive on
	the supplied jig specifies the cutout dimensions		individual colors: 00 (free of charge), 01-25 (extra charge)		Dark Sky Compliance
	minimum distance (meters) lamp - object		luminaire part to be colored (F1)		Americans with Disabilities Act (less than 4" off the wall located between 27"-84" from floor)
	recessed depth		luminaire part to be colored (F2)		lamp protected against explosion
	ceiling thickness in mm		luminaire part to be colored (F3)		blown glass using traditional methods by master glass blower
	ceiling thickness selection		luminaire part to be colored (F4)		acoustic material
	dimmable DP (phase), DV (0-10V), DD (dali), DS (step-dim)		luminaire part to be colored (F5)		protection class I, protection insulation
	included or excluded LED driver/transformer/control gear		color of 3-circuit adaptor		protection class II, protection insulation
	separately switchable		indirect diffuser		ETL Certified to UL and CSA Standards
	sensor		direct diffuser		UL Certified to UL and CSA Standards
	remote control		ball-proof (upon request)		CSA Certified to UL and CSA Standards
	available upon request		accessory		Certified for North American Standards

IP RATING

	protected against ingress of solid bodies greater than 12.5mm (finger)
	protected against ingress of solid bodies greater than 2.5mm protected against sprays of water up to 60 degrees from the vertical (rain)
	protected against ingress of solid bodies greater than 1mm (wire) no protection against the ingress of moisture
	protected against ingress of solid bodies greater than 1mm (wire) protected against sprays of water up to 60 degrees from the vertical (rain)
	protected against ingress of solid bodies greater than 1mm (wire) protected against water splashed from all directions
	protected against limited ingress of dust (wet rooms/covered outdoor areas) protected against water splashed from all directions
	protected against ingress of dust protected against jets of water
	protected against ingress of dust protected against powerful jets of water or heavy seas
	protected against ingress of dust protected against immersion of water between 15cm - 1m for 30 minutes
	protected against ingress of dust protected against immersion of water under pressure for long periods

IK RATING

	protected against 0.14 joules impact (equivalent to 0.25kg mass dropped from 56mm above the surface)
	protected against 0.2 joules impact (equivalent to 0.25kg mass dropped from 80mm above the surface)
	protected against 0.35 joules impact (equivalent to 0.25kg mass dropped from 140mm above the surface)
	protected against 0.5 joules impact (equivalent to 0.25kg mass dropped from 200mm above the surface)
	protected against 0.7 joules impact (equivalent to 0.25kg mass dropped from 280mm above the surface)
	protected against 1 joules impact (equivalent to 0.25kg mass dropped from 400mm above the surface)
	protected against 2 joules impact (equivalent to 0.5kg mass dropped from 400mm above the surface)
	protected against 5 joules impact (equivalent to 1.7kg mass dropped from 300mm above the surface)
	protected against 10 joules impact (equivalent to 5.0kg mass dropped from 200mm above the surface)
	protected against 20 joules impact (equivalent to 5.0kg mass dropped from 400mm above the surface)