

## E12I0025- COMPONENTS

PROJECT

TYPE

NOTES

QUANTITY

DATE

### DND0120024HY

#### DESCRIPTION

Hatch - LV12-24N-UNV-Y - Non-dimming - 12W - 24Vdc - 120-277Vac - LED power supply -Used with ENCP4 -Available with IP68-Outdoor Rated -ENCP20, ENCP22

#### GENERAL

Division: Architectural : Components : LED Drivers

#### PHYSICAL

Length (mm): 75.9

Length (in): 3

Width (mm): 31.2

Width (in): 1 <sup>7</sup>/<sub>32</sub>

Height (mm): 24

Height (in): 1

Fixture Material: Plastic

#### ELECTRICAL

Lamp Type: LED

Input Wattage (W): 16

Total Output Wattage (W): 4.32-12

Dimming: Non-Dimmable

Driver Type: Constant Voltage - Universal

Driver Class: Class 2

Input Voltage (V): 120 - 277

Output Voltage (V): 24

#### RATINGS AND CERTIFICATIONS

Certified By: UR Listed

IP rating: Dry / Damp



## E12I0025- COMPONENTS

PROJECT

TYPE

NOTES

QUANTITY

DATE

### DPH0300024EL

#### DESCRIPTION

EMCOD - MLE30-24DC - Phase dimming (LE / TE) @120Vac only - 1.2-30W - 24Vdc - 120-277Vac - (Outdoor) LED power supply w/UL approved enclosure

#### GENERAL

Division: Architectural : Components : LED Drivers

#### PHYSICAL

Length (mm): 165.1

Length (in): 6 1/2

Width (mm): 91.95

Width (in): 3 5/8

Height (mm): 25.9

Height (in): 1

Weight (kg): 0.09

Weight (lbs): 0.21

Fixture Material: Metal

#### ELECTRICAL

Lamp Type: LED

Total Output Wattage (W): 1.5-30

Dimming: Phase Dimming (120Vac Only)

Driver Type: Constant Voltage - Universal

Driver Class: Class 2

Input Voltage (V): 120 - 277

Output Voltage (V): 24

#### LED

Efficiency (%): 90

#### RATINGS AND CERTIFICATIONS

Certified By: UL Listed

IP rating: Dry / Damp

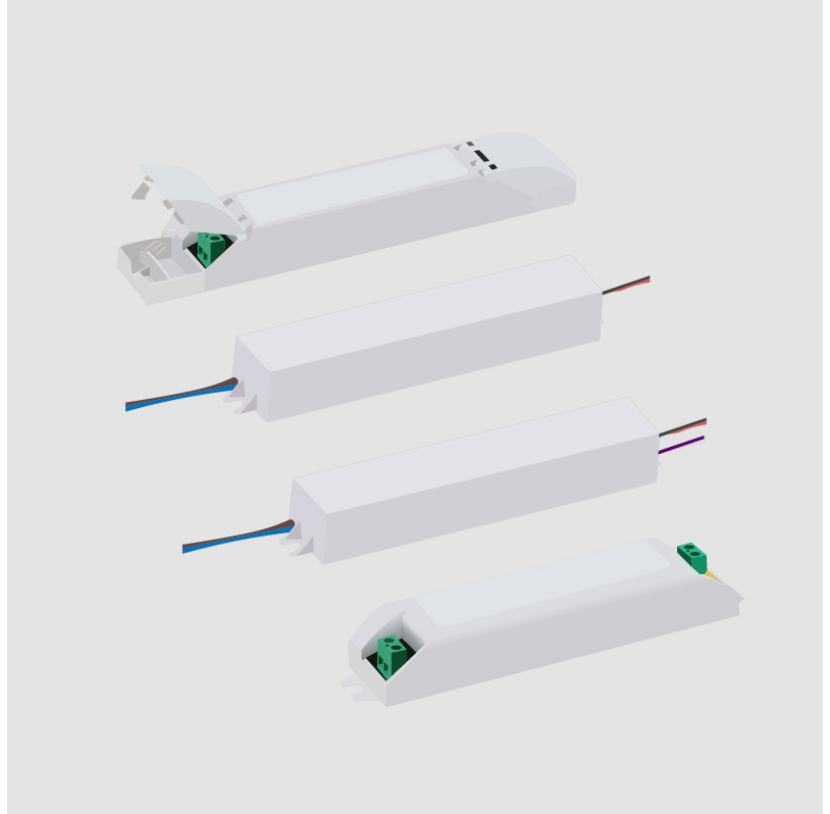

## E12I0025- COMPONENTS

PROJECT	_____
TYPE	_____
NOTES	_____
QUANTITY	_____
DATE	_____

### DVO0160024MF

#### DESCRIPTION

MeanWell - LPF-16D-24 - 1-10Vdc / Resistance / 10V PWM  
Dimming - 5.28-16.08W - 24Vdc - 120-277Vac - LED power supply  
-Used with ENCP5 -Available with IP68-Outdoor Rated -ENCP20,  
ENCP22

#### GENERAL

Division: Architectural

#### PHYSICAL

Length (mm): 151

Length (in): 5 <sup>15</sup>/<sub>16</sub>

Width (mm): 40

Width (in): 1 <sup>37</sup>/<sub>64</sub>

Height (mm): 32

Height (in): 1 <sup>17</sup>/<sub>64</sub>

Weight (kg): 0.21

Weight (lbs): 0.46

Fixture Material: Plastic

#### ELECTRICAL

Lamp Type: LED

Input Wattage (W): 18

Total Output Wattage (W): 5.28- 16.08

Dimming: 1-10V Dimming to 10%

Driver Type: Constant Voltage - Universal

Driver Class: Class 2

Input Voltage (V): 120 - 277

Output Voltage (V): 24

Constant Voltage (V): 13.2-24

#### RATINGS AND CERTIFICATIONS

Certified By: UR Listed

IP rating: IP30

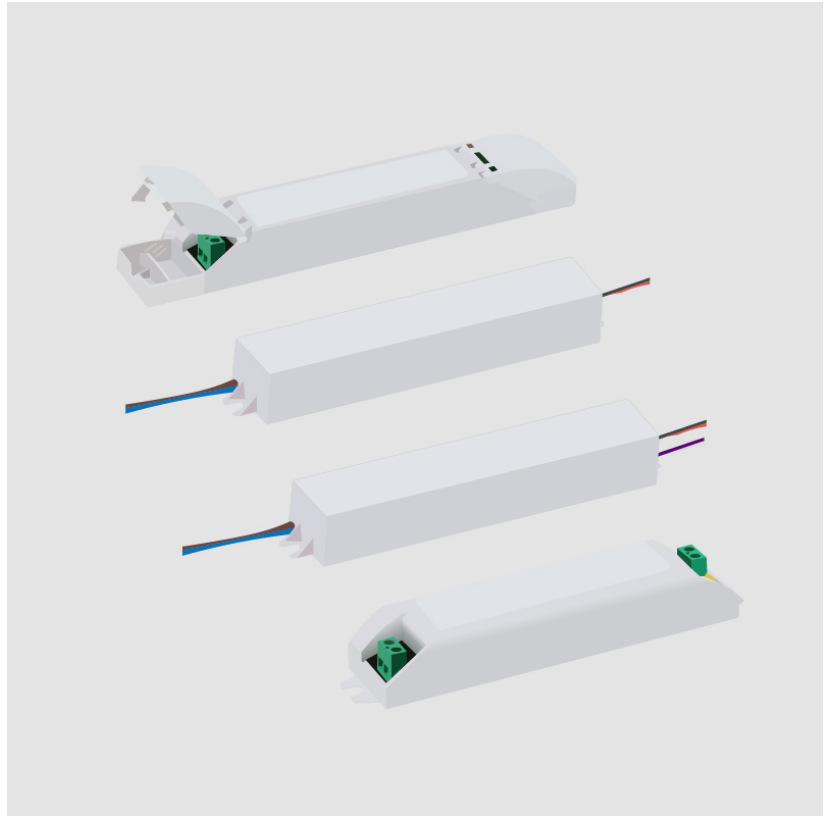

## E12I0025- COMPONENTS

### DVO0300024MUL-E

#### DESCRIPTION

Magnitude - CVD30L24DC - 0-10Vdc Dimming (1%) - 30W - 24Vdc  
- 120-277Vac - LED power supply w/UL Listed Enclosure

#### GENERAL

Division: Architectural : Components : LED Drivers

#### PHYSICAL

Length (mm): 290

Length (in): 11 <sup>27</sup>/<sub>64</sub>

Width (mm): 59.9

Width (in): 2 <sup>23</sup>/<sub>64</sub>

Height (mm): 35

Height (in): 1 <sup>3</sup>/<sub>8</sub>

#### ELECTRICAL

Lamp Type: LED

Total Output Wattage (W): 0-30

Dimming: 0-10V Dimming to 1%

Driver Type: Constant Voltage - Universal

Driver Class: Class 2

Input Voltage (V): 120 - 277

Output Voltage (V): 24

#### RATINGS AND CERTIFICATIONS

Certified By: UL Listed

IP rating: IP65

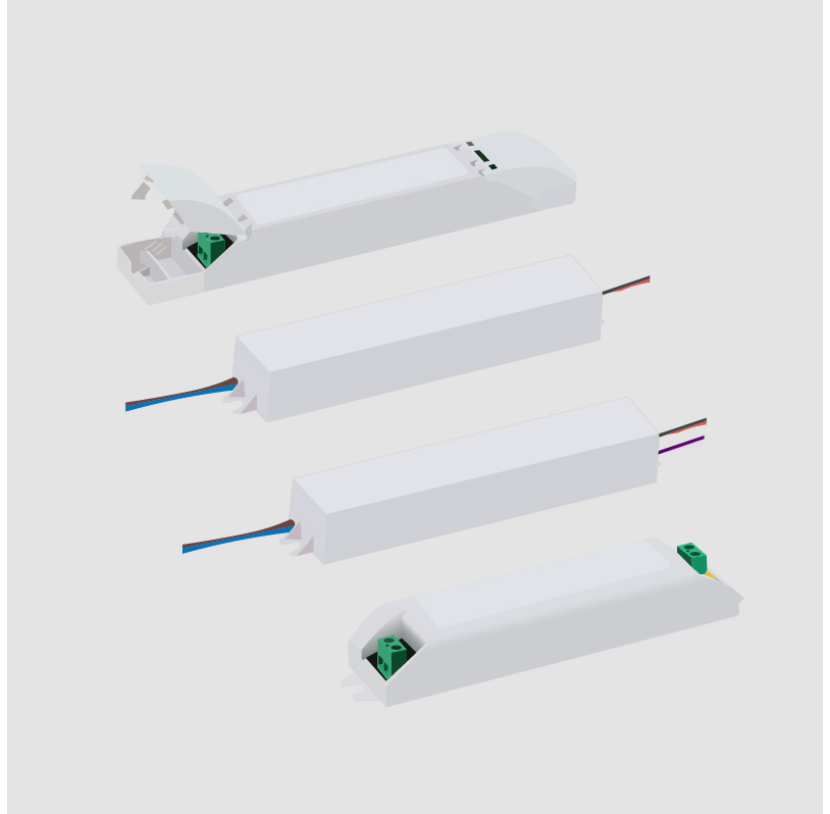

## E12I0025- COMPONENTS

PROJECT	
TYPE	
NOTES	
QUANTITY	
DATE	

### E12A0027

**DESCRIPTION**  
 Caliber 80 - Wall - Fixing springs

**GENERAL**  
 Series: Caliber  
 Brand: Unonovesette  
 Division: Exterior

**RATINGS AND CERTIFICATIONS**  
 Certified By: Certified for North American Standards  
 IP rating: IP68

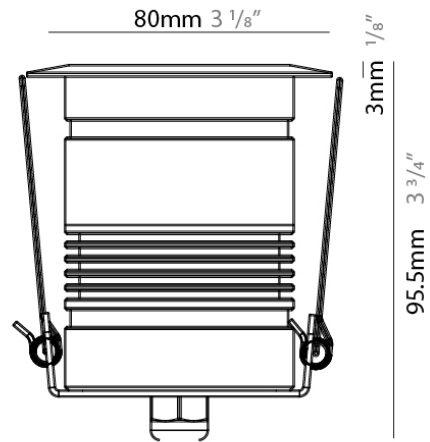
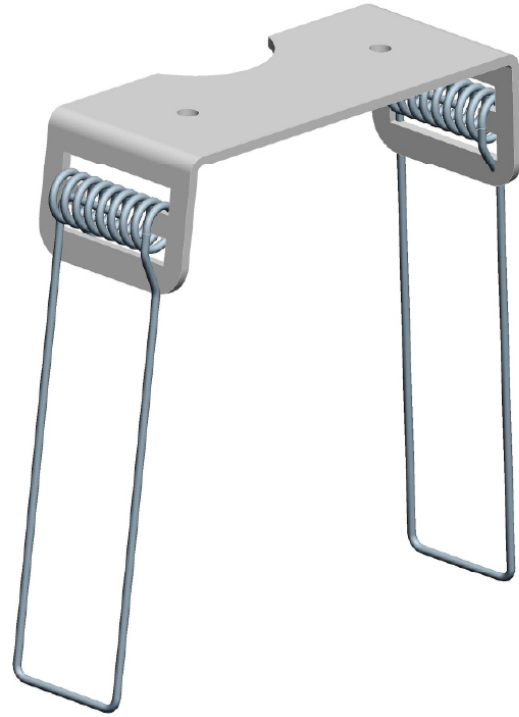

## E12I0025- COMPONENTS

### E12A0028

#### DESCRIPTION

Caliber 80 - Housing box

#### GENERAL

Series: Caliber

Subseries: Caliber 80

Brand: Unonovesette

Division: Exterior

#### PHYSICAL

Diameter (mm): 75

Diameter (in):  $2 \frac{15}{16}$

Height (mm): 120

Height (in):  $4 \frac{3}{4}$

Fixture Material: Plastic

#### RATINGS AND CERTIFICATIONS

Certified By: Certified for North American Standards

IP rating: IP68

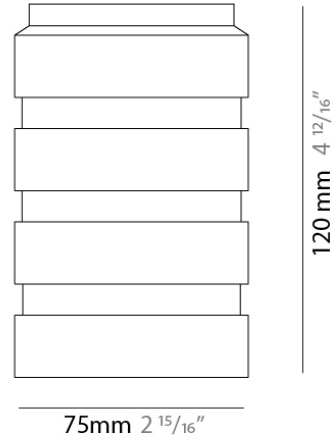

PROJECT	
TYPE	
NOTES	
QUANTITY	
DATE	

## E12I0025- COMPONENTS

### E12A0074

#### DESCRIPTION

0/1-10V dimmer fader sequencer - input 12/24/48Vdc - 1 ch. - Constant Voltage (Required for 0-10V dimming. To be used with Non Dimming Driver)

#### GENERAL

Brand: Unonovesette

Division: Exterior

#### PHYSICAL

Length (mm): 58

Length (in): 2 <sup>5</sup>/<sub>16</sub>

Width (mm): 45

Width (in): 1 <sup>3</sup>/<sub>4</sub>

Height (mm): 25

Height (in): 1

Fixture Material: Plastic

#### RATINGS AND CERTIFICATIONS

Certified By: Certified for North American Standards

IP rating: IP68

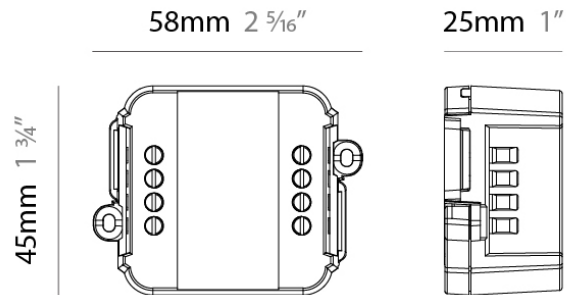

## E12I0025- COMPONENTS

### E12A0075

#### DESCRIPTION

DALI dimmer fader sequencer input - 12/24/48Vdc 1 ch. constant voltage (Required for DALI dimming. To be used with Non Dimming Driver)

#### GENERAL

Brand: Unonovesette

Division: Exterior

#### RATINGS AND CERTIFICATIONS

Certified By: Certified for North American Standards

IP rating: IP68

PROJECT

TYPE

NOTES

QUANTITY

DATE





## E12I0025- COMPONENTS

### E12A0076

#### DESCRIPTION

DALI dimmer fader sequencer input - 12/24/48Vdc 1 ch. constant voltage - IP67 (Required for DALI dimming. To be used with Non Dimming Driver)

#### GENERAL

Brand: Unonovesette

Division: Exterior

#### RATINGS AND CERTIFICATIONS

Certified By: Certified for North American Standards

IP rating: IP68

PROJECT

TYPE

NOTES

QUANTITY

DATE

## E12I0025- COMPONENTS

PROJECT	
TYPE	
NOTES	
QUANTITY	
DATE	

### ENCP4

#### DESCRIPTION

Empty Metal Enclosure for Driver - IP20 - Indoor Rated

#### GENERAL

Division: Architectural

#### PHYSICAL

Shape: Rectangle

Length (mm): 92

Length (in): 3 <sup>5</sup>/<sub>8</sub>

Width (mm): 68

Width (in): 2 <sup>11</sup>/<sub>16</sub>

Height (mm): 40

Height (in): 1 <sup>9</sup>/<sub>16</sub>

Screws: A4 stainless steel

Fixture Material: Metal

#### RATINGS AND CERTIFICATIONS

IP rating: IP20

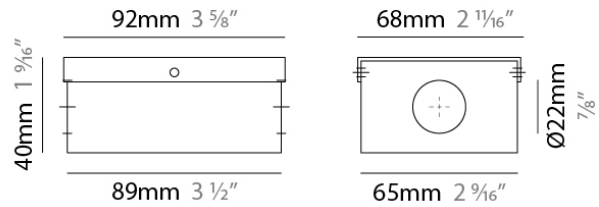

## E12I0025- COMPONENTS

PROJECT
TYPE
NOTES
QUANTITY
DATE

### ENCP9

#### DESCRIPTION

Empty Metal Enclosure for Driver - IP20 - Indoor Rated

#### GENERAL

Division: Architectural : Components

#### PHYSICAL

Shape: Rectangle

Length (mm): 280

Length (in): 11

Width (mm): 58

Width (in): 2 <sup>5</sup>/<sub>16</sub>

Height (mm): 54

Height (in): 2 <sup>1</sup>/<sub>8</sub>

Screws: A4 stainless steel

Fixture Material: Metal

#### RATINGS AND CERTIFICATIONS

IP rating: IP20

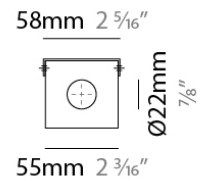
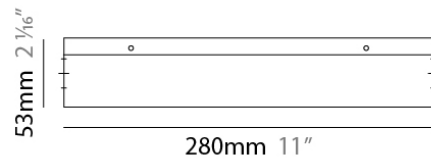

### LEGEND

 floor-mounted	 pivotable	 special LED (upon request) RGB, RGBW, tunable, gold+, meat+, art+, fashion+
 wall and ceiling: recessed and surface mounted	 rotating	 warm dim / natural dimming LED
 ceiling-mounted and wall-mounted	 illuminate tilted	 rechargeable battery powered
 wall-mounted	 color of suspension cable	 fixture with natural vivid LED (upon request)
 omni-directional light distribution	 length of suspension cable	 color rendering index
 direct light distribution	 reflector degree selection	 color temperature
 direct/indirect light distribution	 super spot	 lumen (luminous flux)
 indirect light distribution	 lens	 efficacy (lumens per watt)
 asymmetric light distribution	 lens pack	 Unified Glare Rating (UGR) range from 5-40
 aura light distribution	 shine ring	 marine grade (AISI 316 stainless steel)
 round wall or ceiling cut-out	 integrated shine ring with diffuser	 walk on
 square wall or ceiling cut-out	 free individual colors 01-29	 drive on
 the supplied jig specifies the cutout dimensions	 individual colors: 00 (free of charge), 01-25 (extra charge)	 Dark Sky Compliance
 minimum distance (meters) lamp - object	 luminaire part to be colored (F1)	 Americans with Disabilities Act (less than 4" off the wall located between 27"-84" from floor)
 recessed depth	 luminaire part to be colored (F2)	 lamp protected against explosion
 ceiling thickness in mm	 luminaire part to be colored (F3)	 blown glass using traditional methods by master glass blower
 ceiling thickness selection	 luminaire part to be colored (F4)	 acoustic material
 dimmable DP (phase), DV (0-10V), DD (dali), DS (step-dim)	 luminaire part to be colored (F5)	 protection class I, protection insulation
 included or excluded LED driver/transformer/control gear	 color of 3-circuit adaptor	 protection class II, protection insulation
 separately switchable	 indirect diffuser	 ETL Certified to UL and CSA Standards
 sensor	 direct diffuser	 UL Certified to UL and CSA Standards
 remote control	 ball-proof (upon request)	 CSA Certified to UL and CSA Standards
 available upon request	 accessory	 Certified for North American Standards

### IP RATING

 IP20	protected against ingress of solid bodies greater than 12.5mm (finger)
 IP33	protected against ingress of solid bodies greater than 2.5mm protected against sprays of water up to 60 degrees from the vertical (rain)
 IP40	protected against ingress of solid bodies greater than 1mm (wire) no protection against the ingress of moisture
 IP43	protected against ingress of solid bodies greater than 1mm (wire) protected against sprays of water up to 60 degrees from the vertical (rain)
 IP44	protected against ingress of solid bodies greater than 1mm (wire) protected against water splashed from all directions
 IP54	protected against limited ingress of dust (wet rooms/covered outdoor areas) protected against water splashed from all directions
 IP65	protected against ingress of dust protected against jets of water
 IP66	protected against ingress of dust protected against powerful jets of water or heavy seas
 IP67	protected against ingress of dust protected against immersion of water between 15cm - 1m for 30 minutes
 IP68	protected against ingress of dust protected against immersion of water under pressure for long periods

### IK RATING

 IK01	protected against 0.14 joules impact (equivalent to 0.25kg mass dropped from 56mm above the surface)
 IK02	protected against 0.2 joules impact (equivalent to 0.25kg mass dropped from 80mm above the surface)
 IK03	protected against 0.35 joules impact (equivalent to 0.25kg mass dropped from 140mm above the surface)
 IK04	protected against 0.5 joules impact (equivalent to 0.25kg mass dropped from 200mm above the surface)
 IK05	protected against 0.7 joules impact (equivalent to 0.25kg mass dropped from 280mm above the surface)
 IK06	protected against 1 joules impact (equivalent to 0.25kg mass dropped from 400mm above the surface)
 IK07	protected against 2 joules impact (equivalent to 0.5kg mass dropped from 400mm above the surface)
 IK08	protected against 5 joules impact (equivalent to 1.7kg mass dropped from 300mm above the surface)
 IK09	protected against 10 joules impact (equivalent to 5.0kg mass dropped from 200mm above the surface)
 IK10	protected against 20 joules impact (equivalent to 5.0kg mass dropped from 400mm above the surface)