

## E12S0003- COMPONENTS

### DAL20150SETTC

#### DESCRIPTION

TCI - MINI JOLLY DALI 20 - DALI Dimming - 2-15W - 250-700mA or 24Vdc - 120Vac - LED power supply / P/N: 125403 - Used with ENCP13 - Available with IP68-Outdoor Rated - ENCP20, ENCP22

#### GENERAL

Division: Architectural : Components : LED Drivers

#### PHYSICAL

Shape: Rectangle

Length (mm): 115

Length (in): 4 1/2

Width (mm): 52

Width (in): 2

Height (mm): 22

Height (in): 7/8

Weight (kg): 0.11

Weight (lbs): 0.24

Fixture Finish: BLK

Fixture Material: Plastic

#### ELECTRICAL

Lamp Type: LED

Total Output Wattage (W): 0.7-15

Dimming: Dali Dimming

Driver Type: Constant Current / Constant Voltage - 120Vac

Driver Class: Class 2

Input Voltage (V): 120

Constant Current (MA): 250-700

Constant Voltage (V): 3-49 Dependent on Switch

#### LED

Efficiency (%): 92

#### RATINGS AND CERTIFICATIONS

Certified By: UR Listed

IP rating: Dry / Damp

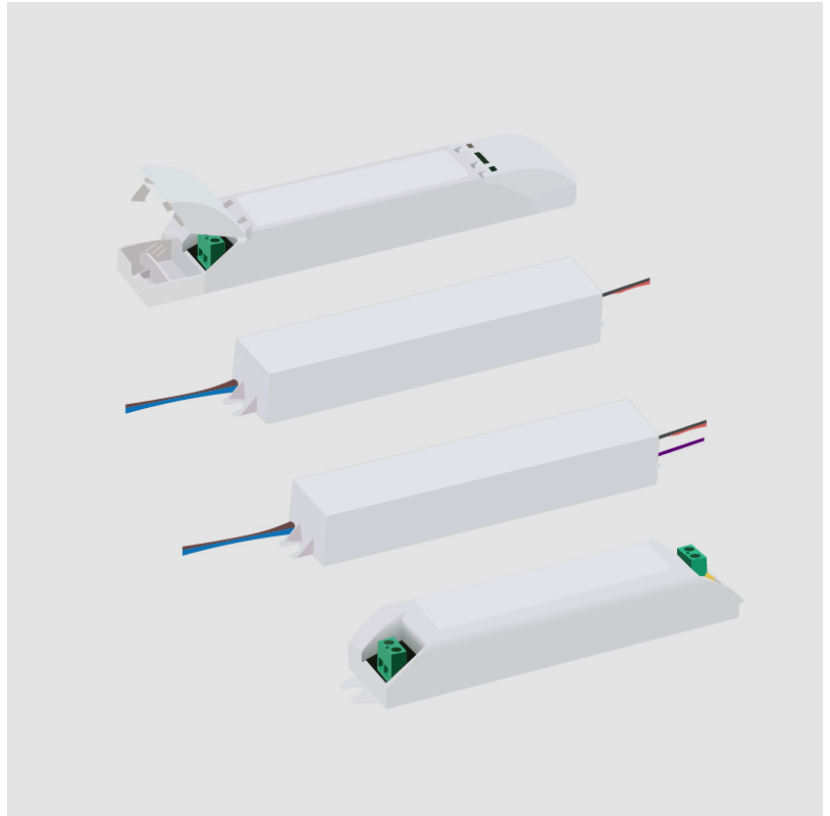

## E12S0003- COMPONENTS

### DND0120024HY

#### DESCRIPTION

Hatch - LV12-24N-UNV-Y - Non-dimming - 12W - 24Vdc - 120-277Vac - LED power supply -Used with ENCP4 -Available with IP68-Outdoor Rated -ENCP20, ENCP22

#### GENERAL

Division: Architectural : Components : LED Drivers

#### PHYSICAL

Length (mm): 75.9

Length (in): 3

Width (mm): 31.2

Width (in): 1  $\frac{7}{32}$

Height (mm): 24

Height (in): 1

Fixture Material: Plastic

#### ELECTRICAL

Input Wattage Range: 10 - 19 W

Lamp Type: LED

Input Wattage (W): 12

Total Output Wattage (W): 4.32-12

Dimming: Non-Dimmable

Driver Type: Constant Voltage - Universal

Driver Class: Class 2

Input Voltage (V): 120 - 277

Output Voltage (V): 24

#### RATINGS AND CERTIFICATIONS

Certified By: UR Listed

IP rating: Dry / Damp



## E12S0003- COMPONENTS

### DVO0160024MF

#### DESCRIPTION

MeanWell - LPF-16D-24 - 1-10Vdc / Resistance / 10V PWM  
Dimming - 5.28-16.08W - 24Vdc - 120-277Vac - LED power supply  
-Used with ENCP5 -Available with IP68-Outdoor Rated -ENCP20,  
ENCP22

#### GENERAL

Division: Architectural

#### PHYSICAL

Length (mm): 151

Length (in): 5 <sup>15</sup>/<sub>16</sub>

Width (mm): 40

Width (in): 1 <sup>37</sup>/<sub>64</sub>

Height (mm): 32

Height (in): 1 <sup>17</sup>/<sub>64</sub>

Weight (kg): 0.21

Weight (lbs): 0.46

Fixture Material: Plastic

#### ELECTRICAL

Lamp Type: LED

Input Wattage (W): 18

Total Output Wattage (W): 5.28- 16.08

Dimming: 1-10V Dimming to 10%

Driver Type: Constant Voltage - Universal

Driver Class: Class 2

Input Voltage (V): 120 - 277

Output Voltage (V): 24

Constant Voltage (V): 13.2-24

#### RATINGS AND CERTIFICATIONS

Certified By: UR Listed

IP rating: IP30

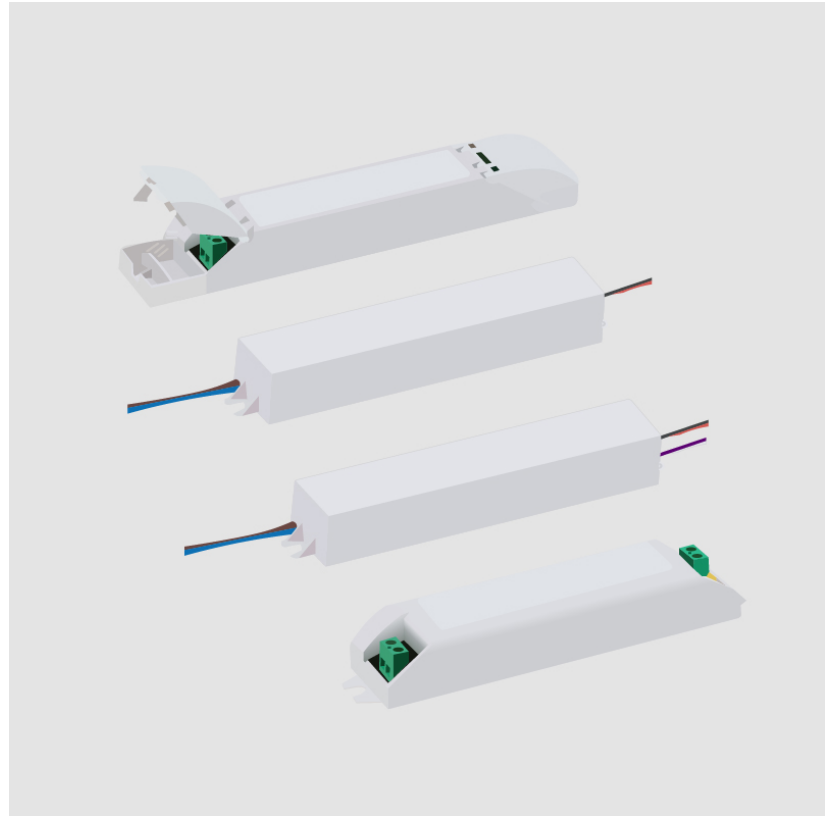

## E12S0003- COMPONENTS

PROJECT	
TYPE	
NOTES	
QUANTITY	
DATE	

### ENCP13

**DESCRIPTION**  
Empty Metal Enclosure for Driver - IP20 - Indoor Rated

**GENERAL**  
Division: Architectural : Components

**PHYSICAL**  
Shape: Rectangle  
Length (mm): 203  
Length (in): 8  
Width (mm): 68  
Width (in): 2 11/16  
Height (mm): 54  
Height (in): 2 1/8  
Fixture Material: Metal

**RATINGS AND CERTIFICATIONS**  
IP rating: IP20

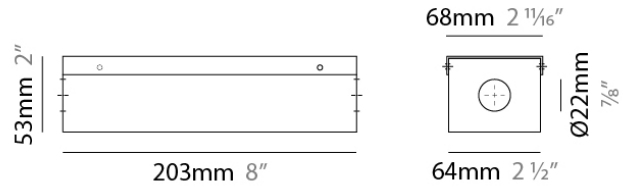

## E12S0003- COMPONENTS

PROJECT	_____
TYPE	_____
NOTES	_____
QUANTITY	_____
DATE	_____

### ENCP20

#### DESCRIPTION

Polycarbonate - IP68 - Outdoor Rated - UL listed - Power Supply Enclosure in Light Gray

#### GENERAL

Division: Architectural : Components

#### PHYSICAL

Shape: Rectangle

Length (mm): 160

Length (in): 6  $\frac{5}{16}$ "

Width (mm): 90

Width (in): 3  $\frac{5}{16}$ "

Height (mm): 61

Height (in): 2  $\frac{3}{8}$ "

Weight (kg): 0.24

Weight (lbs): 0.53

Screws: A4 stainless steel

Gasket: 1554JGASKET

Fixture Material: Plastic

#### RATINGS AND CERTIFICATIONS

Certified By: UL Listed

IP rating: IP68

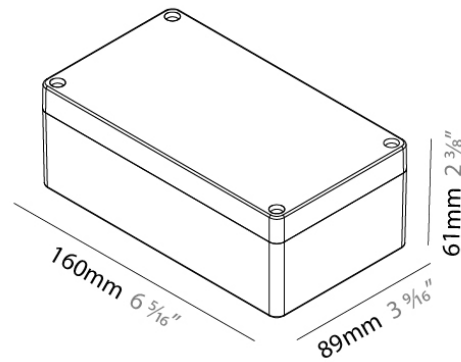

## E12S0003- COMPONENTS

PROJECT \_\_\_\_\_

TYPE \_\_\_\_\_

NOTES \_\_\_\_\_

QUANTITY \_\_\_\_\_

DATE \_\_\_\_\_

### ENCP22

#### DESCRIPTION

Polycarbonate - IP68 - Outdoor Rated - UL listed - Power Supply Enclosure in Light Gray

#### GENERAL

Division: Architectural : Components

#### PHYSICAL

Shape: Rectangle

Length (mm): 238.8

Length (in): 9 <sup>13</sup>/<sub>32</sub>

Width (mm): 160

Width (in): 6 <sup>5</sup>/<sub>16</sub>

Height (mm): 60

Height (in): 2 <sup>3</sup>/<sub>8</sub>

Weight (kg): 0.51

Weight (lbs): 1.14

Screws: A4 stainless steel

Gasket: 1554VAGASKET

Fixture Material: Plastic

#### RATINGS AND CERTIFICATIONS

Certified By: UL Listed

IP rating: IP68

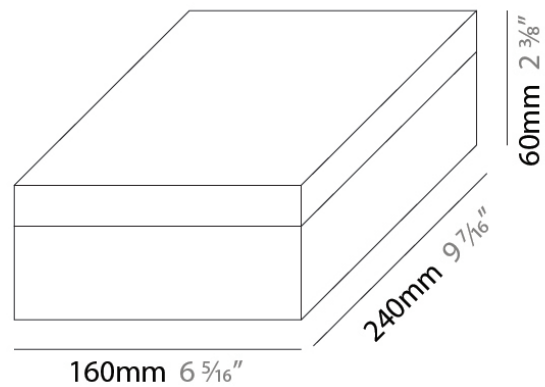

## E12S0003- COMPONENTS

### ENCP4

#### DESCRIPTION

Empty Metal Enclosure for Driver - IP20 - Indoor Rated

#### GENERAL

Division: Architectural

#### PHYSICAL

Shape: Rectangle

Length (mm): 92

Length (in): 3 <sup>5</sup>/<sub>8</sub>

Width (mm): 68

Width (in): 2 <sup>11</sup>/<sub>16</sub>

Height (mm): 40

Height (in): 1 <sup>9</sup>/<sub>16</sub>

Screws: A4 stainless steel

Fixture Material: Metal

#### RATINGS AND CERTIFICATIONS

IP rating: IP20

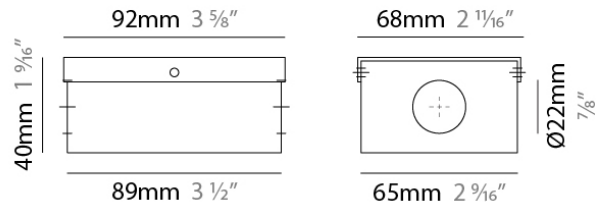

## E12S0003- COMPONENTS

PROJECT	
TYPE	
NOTES	
QUANTITY	
DATE	

### ENCP9

**DESCRIPTION**  
Empty Metal Enclosure for Driver - IP20 - Indoor Rated

**GENERAL**  
Division: Architectural : Components

**PHYSICAL**  
Shape: Rectangle  
Length (mm): 280  
Length (in): 11  
Width (mm): 58  
Width (in): 2 5/16  
Height (mm): 54  
Height (in): 2 1/8  
Screws: A4 stainless steel  
Fixture Material: Metal



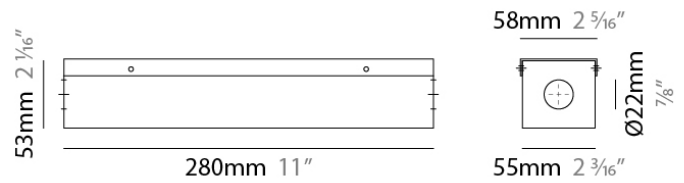







**RATINGS AND CERTIFICATIONS**  
IP rating: IP20













### LEGEND

	floor-mounted		pivotal		special LED (upon request) RGB, RGBW, tunable, gold+, meat+, art+, fashion+
	wall and ceiling: recessed and surface mounted		rotating		warm dim / natural dimming LED
	ceiling-mounted and wall-mounted		illuminate tilted		rechargeable battery powered
	wall-mounted		color of suspension cable		fixture with natural vivid LED (upon request)
	omni-directional light distribution		length of suspension cable		color rendering index
	direct light distribution		reflector degree selection		color temperature
	direct/indirect light distribution		super spot		lumen (luminous flux)
	indirect light distribution		lens		efficacy (lumens per watt)
	asymmetric light distribution		lens pack		Unified Glare Rating (UGR) range from 5-40
	aura light distribution		shine ring		marine grade (AISI 316 stainless steel)
	round wall or ceiling cut-out		integrated shine ring with diffuser		walk on
	square wall or ceiling cut-out		free individual colors 01-29		drive on
	the supplied jig specifies the cutout dimensions		individual colors: 00 (free of charge), 01-25 (extra charge)		Dark Sky Compliance
	minimum distance (meters) lamp - object		luminaire part to be colored (F1)		Americans with Disabilities Act (less than 4" off the wall located between 27"-84" from floor)
	recessed depth		luminaire part to be colored (F2)		lamp protected against explosion
	ceiling thickness in mm		luminaire part to be colored (F3)		blown glass using traditional methods by master glass blower
	ceiling thickness selection		luminaire part to be colored (F4)		acoustic material
	dimmable DP (phase), DV (0-10V), DD (dali), DS (step-dim)		luminaire part to be colored (F5)		protection class I, protection insulation
	included or excluded LED driver/transformer/control gear		color of 3-circuit adaptor		protection class II, protection insulation
	separately switchable		indirect diffuser		ETL Certified to UL and CSA Standards
	sensor		direct diffuser		UL Certified to UL and CSA Standards
	remote control		ball-proof (upon request)		CSA Certified to UL and CSA Standards
	available upon request		accessory		Certified for North American Standards

### IP RATING

	protected against ingress of solid bodies greater than 12.5mm (finger)
	protected against ingress of solid bodies greater than 2.5mm protected against sprays of water up to 60 degrees from the vertical (rain)
	protected against ingress of solid bodies greater than 1mm (wire) no protection against the ingress of moisture
	protected against ingress of solid bodies greater than 1mm (wire) protected against sprays of water up to 60 degrees from the vertical (rain)
	protected against ingress of solid bodies greater than 1mm (wire) protected against water splashed from all directions
	protected against limited ingress of dust (wet rooms/covered outdoor areas) protected against water splashed from all directions
	protected against ingress of dust protected against jets of water
	protected against ingress of dust protected against powerful jets of water or heavy seas
	protected against ingress of dust protected against immersion of water between 15cm - 1m for 30 minutes
	protected against ingress of dust protected against immersion of water under pressure for long periods

### IK RATING

	protected against 0.14 joules impact (equivalent to 0.25kg mass dropped from 56mm above the surface)
	protected against 0.2 joules impact (equivalent to 0.25kg mass dropped from 80mm above the surface)
	protected against 0.35 joules impact (equivalent to 0.25kg mass dropped from 140mm above the surface)
	protected against 0.5 joules impact (equivalent to 0.25kg mass dropped from 200mm above the surface)
	protected against 0.7 joules impact (equivalent to 0.25kg mass dropped from 280mm above the surface)
	protected against 1 joules impact (equivalent to 0.25kg mass dropped from 400mm above the surface)
	protected against 2 joules impact (equivalent to 0.5kg mass dropped from 400mm above the surface)
	protected against 5 joules impact (equivalent to 1.7kg mass dropped from 300mm above the surface)
	protected against 10 joules impact (equivalent to 5.0kg mass dropped from 200mm above the surface)
	protected against 20 joules impact (equivalent to 5.0kg mass dropped from 400mm above the surface)