

E9F427- COMPONENTS

DND0100024HA

DESCRIPTION

Hatch - LV10-24N-120-A - Non-dimming - 10W - 24Vdc - 120Vac - LED power supply -Used with ENCP4 -Available with IP68- Outdoor Rated -ENCP20, ENCP22

GENERAL

Division: Architectural : Components : LED Drivers

PHYSICAL

Length (mm): 68.6

Length (in): 2 ¹¹/₁₆

Width (mm): 33

Width (in): 1 ³/₃₂

Height (mm): 20.3

Height (in): 7/32

Fixture Material: Plastic

ELECTRICAL

Lamp Type: LED

Input Wattage (W): 13

Total Output Wattage (W): 5.68-10

Dimming: Non-Dimmable

Driver Type: Constant Voltage - 120Vac

Driver Class: Class 2

Input Voltage (V): 120

Output Voltage (V): 24

RATINGS AND CERTIFICATIONS

Certified By: UR Listed

IP rating: Dry / Damp



E9F427- COMPONENTS

PROJECT

TYPE

NOTES

QUANTITY

DATE

DVO0600024TLC

DESCRIPTION

Tridonic Driver - LC 60W 24V 0-10V Ip SNC UNV - 0-10Vdc
Dimming (5%) - 60W - 24Vdc - 120-277Vac - LED power supply

GENERAL

Division: Architectural

PHYSICAL

Length (mm): 148.2

Length (in): 5 ¹³/₁₆

Width (mm): 45.6

Width (in): 1 ¹³/₁₆

Height (mm): 25.4

Height (in): 1

Weight (kg): 0.335

Weight (lbs): 0.75

Fixture Material: Metal

ELECTRICAL

Lamp Type: LED

Input Wattage (W): 75

Total Output Wattage (W): 0-60

Dimming: 0-10V Dimming

Driver Type: Constant Voltage - Universal

Driver Class: Class 2

Housing: Outdoor - ENCP22

Input Voltage (V): 120 - 277

Output Voltage (V): 24

Constant Voltage (V): 24

RATINGS AND CERTIFICATIONS

Certified By: UL Listed

IP rating: Dry / Damp

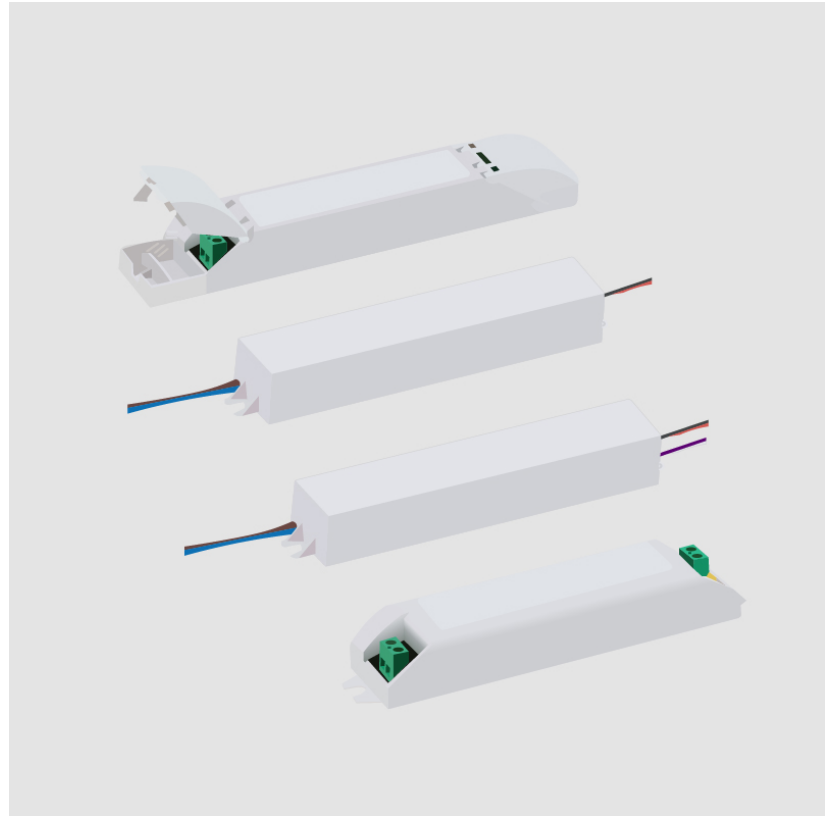

E9F427- COMPONENTS

PROJECT

TYPE

NOTES

QUANTITY

DATE

E9A02300

DESCRIPTION

IP68 gel connector - max 2 x 0,75 mm²

GENERAL

Partner: Platek

Division: Exterior

PHYSICAL

Diameter (mm): 4.8

Diameter (in): 3/16

Length (mm): 6

Length (in): 1/4

Fixture Finish: BLK

Fixture Material: Plastic

RATINGS AND CERTIFICATIONS

Certified By: CSA Certified to UL and CSA Standards



PROJECT	_____
TYPE	_____
NOTES	_____
QUANTITY	_____
DATE	_____

E9F427- COMPONENTS

E9A18400

DESCRIPTION

Anchor belt - Accessory

GENERAL

Partner: Platek

Division: Exterior

RATINGS AND CERTIFICATIONS

Certified By: Certified for North American Standards

IP rating: IP65



1000mm 39 3/8"

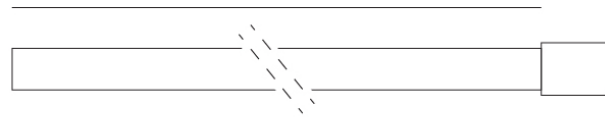

E9F427- COMPONENTS

PROJECT _____

TYPE _____

NOTES _____

QUANTITY _____

DATE _____

E9A25400

DESCRIPTION

IP68 Gel Connector for parallel connection - max. 4 x 1.5 mm²
Ø4.5 - 8.5 mm

GENERAL

Partner: Platek _____

Division: Exterior _____

PHYSICAL

Fixture Material: Plastic _____

RATINGS AND CERTIFICATIONS

Certified By: Certified for North American Standards _____

IP rating: IP65 _____



E9F427- COMPONENTS

E9A50103

DESCRIPTION

Ring for tree application for Raygun 35, 50, 80

GENERAL

Series: Raygun

Partner: Platek

Division: Exterior

RATINGS AND CERTIFICATIONS

Certified By: Certified for North American Standards



E9F427- COMPONENTS

E9A50105

DESCRIPTION

Raygun - 300mm/11 13/16" Stainless Steel Rod and Spike -
Stainless Steel

GENERAL

Series: Raygun _____

Partner: Platek _____

Division: Exterior _____

PHYSICAL

Height (mm): 300 _____

Height (in): 11 ¹³/₁₆ _____

Fixture Finish: SST _____

Fixture Material: Stainless Steel _____

Primary Material: Stainless Steel _____

RATINGS AND CERTIFICATIONS

Certified By: Certified for North American Standards _____

IP rating: IP65 _____

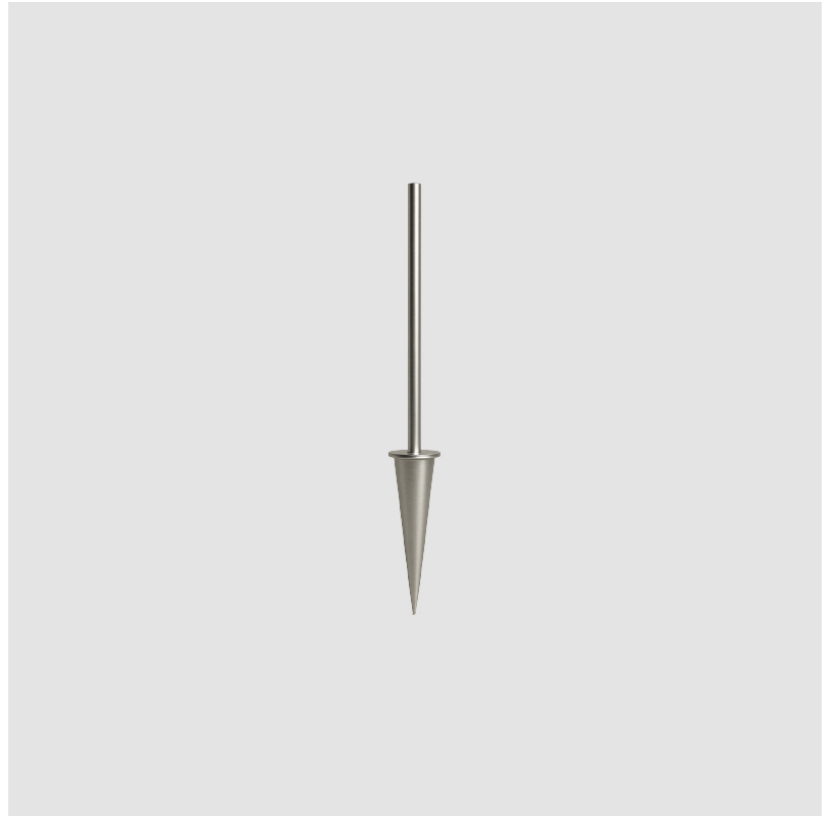

E9F427- COMPONENTS

PROJECT _____

TYPE _____

NOTES _____

QUANTITY _____

DATE _____

E9A50106

DESCRIPTION

Raygun - 600mm/23 5/8" Stainless Steel Rod and Spike

GENERAL

Series: Raygun

Partner: Platek

Division: Exterior

PHYSICAL

Height (mm): 600

Height (in): 23 5/8

Fixture Material: Stainless Steel

Primary Material: Stainless Steel

RATINGS AND CERTIFICATIONS

Certified By: Certified for North American Standards

IP rating: IP65

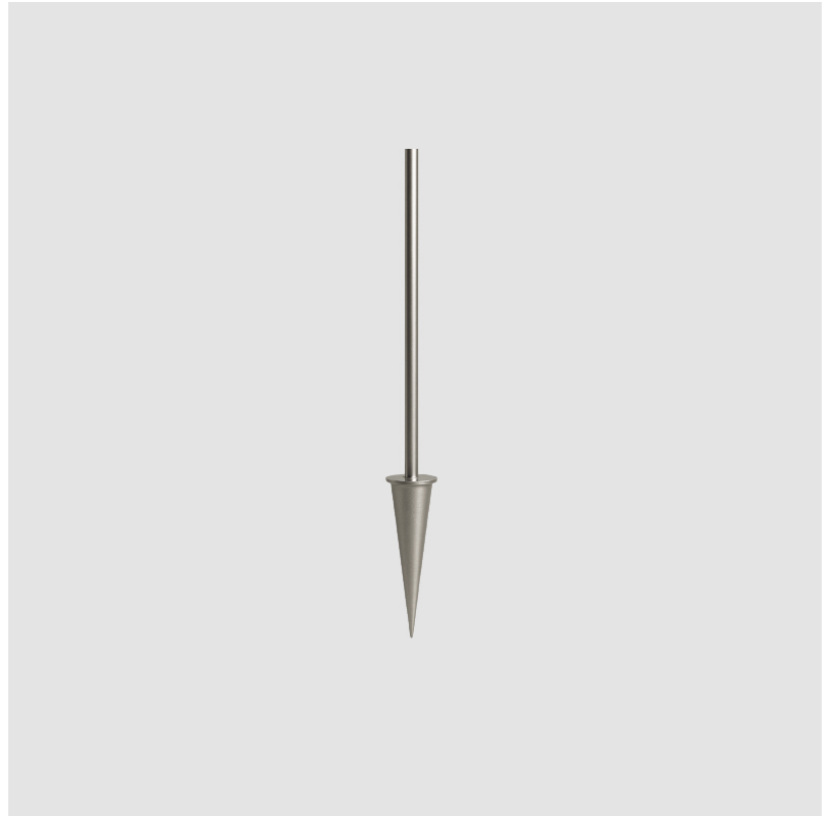

E9F427- COMPONENTS

E9A50107

DESCRIPTION

Raygun - 1100mm/43 5/16" Stainless Steel Rod and Spike

GENERAL

Series: Raygun

Partner: Platek

Division: Exterior

PHYSICAL

Height (mm): 1100

Height (in): 43 ⁵/₁₆

Fixture Finish: SST

Fixture Material: Stainless Steel

Primary Material: Stainless Steel

RATINGS AND CERTIFICATIONS

Certified By: Certified for North American Standards

IP rating: IP65



E9F427- COMPONENTS

E9A50108

DESCRIPTION

Raygun - 1700mm/66 15/16" Stainless Steel Rod and Spike

GENERAL

Series: Raygun

Partner: Platek

Division: Exterior

PHYSICAL

Height (mm): 1700

Height (in): 66 ¹⁵/₁₆

Fixture Finish: SST

Fixture Material: Stainless Steel

Primary Material: Stainless Steel

RATINGS AND CERTIFICATIONS

Certified By: Certified for North American Standards

IP rating: IP65



E9F427- COMPONENTS

PROJECT	
TYPE	
NOTES	
QUANTITY	
DATE	

ENCP1

DESCRIPTION
Empty Metal Enclosure for Driver - IP20 - Indoor Rated

GENERAL
Division: Architectural : Components

PHYSICAL
Shape: Rectangle
Length (mm): 197
Length (in): 7 ¾
Width (mm): 41
Width (in): 1 ⅝
Height (mm): 41
Height (in): 1 ⅝
Screws: A4 stainless steel
Fixture Material: Metal

RATINGS AND CERTIFICATIONS
IP rating: IP20

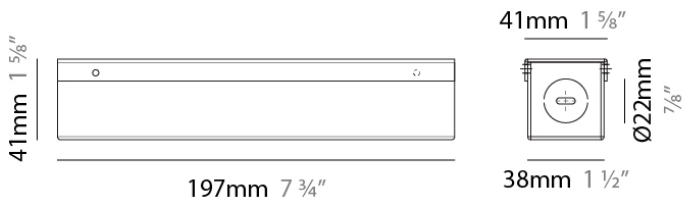

E9F427- COMPONENTS

PROJECT	_____
TYPE	_____
NOTES	_____
QUANTITY	_____
DATE	_____

ENCP20

DESCRIPTION

Polycarbonate - IP68 - Outdoor Rated - UL listed - Power Supply Enclosure in Light Gray

GENERAL

Division: Architectural : Components

PHYSICAL

Shape: Rectangle

Length (mm): 160

Length (in): $6 \frac{5}{16}$

Width (mm): 90

Width (in): $3 \frac{5}{16}$

Height (mm): 61

Height (in): $2 \frac{3}{8}$

Weight (kg): 0.24

Weight (lbs): 0.53

Screws: A4 stainless steel

Gasket: 1554JGASKET

Fixture Material: Plastic

RATINGS AND CERTIFICATIONS

Certified By: UL Listed

IP rating: IP68

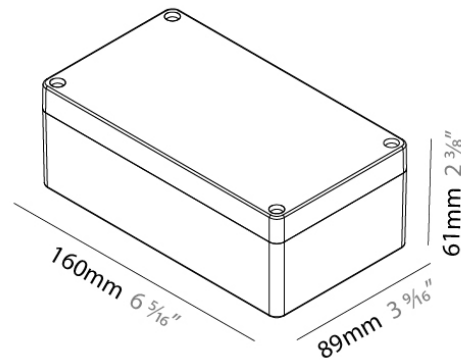

E9F427- COMPONENTS

PROJECT _____

TYPE _____

NOTES _____

QUANTITY _____

DATE _____

ENCP22

DESCRIPTION

Polycarbonate - IP68 - Outdoor Rated - UL listed - Power Supply Enclosure in Light Gray

GENERAL

Division: Architectural : Components

PHYSICAL

Shape: Rectangle

Length (mm): 238.8

Length (in): 9 ¹³/₃₂

Width (mm): 160

Width (in): 6 ⁵/₁₆

Height (mm): 60

Height (in): 2 ³/₈

Weight (kg): 0.51

Weight (lbs): 1.14

Screws: A4 stainless steel

Gasket: 1554VAGASKET

Fixture Material: Plastic

RATINGS AND CERTIFICATIONS

Certified By: UL Listed

IP rating: IP68

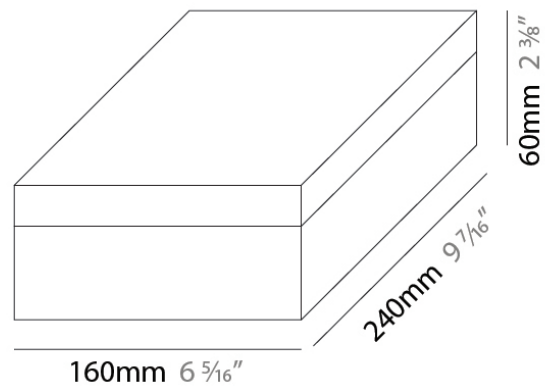

E9F427- COMPONENTS

PROJECT	
TYPE	
NOTES	
QUANTITY	
DATE	

ENCP3

DESCRIPTION

Empty Metal Enclosure for Driver - IP20 - Indoor Rated

GENERAL

Division: Architectural

PHYSICAL

Shape: Rectangle

Length (mm): 155

Length (in): 6 ¹/₈"

Width (mm): 54

Width (in): 2 ¹/₈"

Height (mm): 36

Height (in): 1 ³/₈"

Screws: A4 stainless steel

Fixture Material: Metal

RATINGS AND CERTIFICATIONS

IP rating: IP20

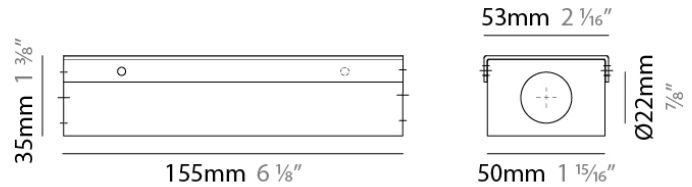

E9F427- COMPONENTS

PROJECT	
TYPE	
NOTES	
QUANTITY	
DATE	

ENCP6

DESCRIPTION

Empty Metal Enclosure for Driver - IP20 - Indoor Rated

GENERAL

Division: Architectural : Components

PHYSICAL

Shape: Rectangle

Length (mm): 178

Length (in): 7

Width (mm): 105

Width (in): 4 1/8

Height (mm): 54

Height (in): 2 1/8

Screws: A4 stainless steel

Fixture Material: Metal

RATINGS AND CERTIFICATIONS

IP rating: IP20

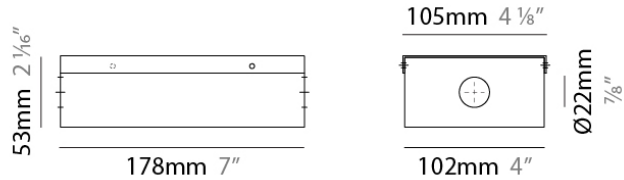

E9F427- COMPONENTS

PROJECT	
TYPE	
NOTES	
QUANTITY	
DATE	

ENCP8

DESCRIPTION

Empty Metal Enclosure for Driver - IP20 - Indoor Rated

GENERAL

Division: Architectural : Components

PHYSICAL

Shape: Rectangle

Length (mm): 305

Length (in): 12

Width (mm): 92

Width (in): 3 5/8

Height (mm): 54

Height (in): 2 1/8

Fixture Material: Metal

RATINGS AND CERTIFICATIONS

IP rating: IP20

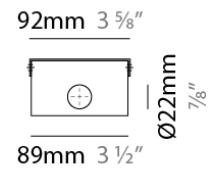
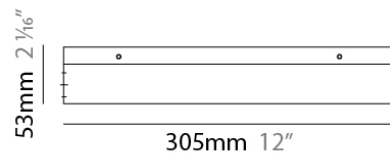











LEGEND

	floor-mounted		pivotable		special LED (upon request) RGB, RGBW, tunable, gold+, meat+, art+, fashion+
	wall and ceiling: recessed and surface mounted		rotating		warm dim / natural dimming LED
	ceiling-mounted and wall-mounted		illuminate tilted		rechargeable battery powered
	wall-mounted		color of suspension cable		fixture with natural vivid LED (upon request)
	omni-directional light distribution		length of suspension cable		CRI color rendering index
	direct light distribution		reflector degree selection		color temperature
	direct/indirect light distribution		super spot		lumen (luminous flux)
	indirect light distribution		lens		efficacy (lumens per watt)
	asymmetric light distribution		lens pack		Unified Glare Rating (UGR) range from 5-40
	aura light distribution		shine ring		marine grade (AISI 316 stainless steel)
	round wall or ceiling cut-out		integrated shine ring with diffuser		walk on
	square wall or ceiling cut-out		free individual colors 01-29		drive on
	the supplied jig specifies the cutout dimensions		individual colors: 00 (free of charge), 01-25 (extra charge)		Dark Sky Compliance
	minimum distance (meters) lamp - object		luminaire part to be colored (F1)		Americans with Disabilities Act (less than 4" off the wall located between 27"-84" from floor)
	recessed depth		luminaire part to be colored (F2)		lamp protected against explosion
	ceiling thickness in mm		luminaire part to be colored (F3)		blown glass using traditional methods by master glass blower
	ceiling thickness selection		luminaire part to be colored (F4)		acoustic material
	dimmable DP (phase), DV (0-10V), DD (dali), DS (step-dim)		luminaire part to be colored (F5)		protection class I, protection insulation
	included or excluded LED driver/transformer/control gear		color of 3-circuit adaptor		protection class II, protection insulation
	separately switchable		indirect diffuser		ETL Certified to UL and CSA Standards
	sensor		direct diffuser		UL Certified to UL and CSA Standards
	remote control		ball-proof (upon request)		CSA Certified to UL and CSA Standards
	available upon request		accessory		Certified for North American Standards

IP RATING

	protected against ingress of solid bodies greater than 12.5mm (finger)
	protected against ingress of solid bodies greater than 2.5mm protected against sprays of water up to 60 degrees from the vertical (rain)
	protected against ingress of solid bodies greater than 1mm (wire) no protection against the ingress of moisture
	protected against ingress of solid bodies greater than 1mm (wire) protected against sprays of water up to 60 degrees from the vertical (rain)
	protected against ingress of solid bodies greater than 1mm (wire) protected against water splashed from all directions
	protected against limited ingress of dust (wet rooms/covered outdoor areas) protected against water splashed from all directions
	protected against ingress of dust protected against jets of water
	protected against ingress of dust protected against powerful jets of water or heavy seas
	protected against ingress of dust protected against immersion of water between 15cm - 1m for 30 minutes
	protected against ingress of dust protected against immersion of water under pressure for long periods

IK RATING

	protected against 0.14 joules impact (equivalent to 0.25kg mass dropped from 56mm above the surface)
	protected against 0.2 joules impact (equivalent to 0.25kg mass dropped from 80mm above the surface)
	protected against 0.35 joules impact (equivalent to 0.25kg mass dropped from 140mm above the surface)
	protected against 0.5 joules impact (equivalent to 0.25kg mass dropped from 200mm above the surface)
	protected against 0.7 joules impact (equivalent to 0.25kg mass dropped from 280mm above the surface)
	protected against 1 joules impact (equivalent to 0.25kg mass dropped from 400mm above the surface)
	protected against 2 joules impact (equivalent to 0.5kg mass dropped from 400mm above the surface)
	protected against 5 joules impact (equivalent to 1.7kg mass dropped from 300mm above the surface)
	protected against 10 joules impact (equivalent to 5.0kg mass dropped from 200mm above the surface)
	protected against 20 joules impact (equivalent to 5.0kg mass dropped from 400mm above the surface)