

E9F432-HC- COMPONENTS

PROJECT	_____
TYPE	_____
NOTES	_____
QUANTITY	_____
DATE	_____

DVO0600024TLC

DESCRIPTION

Tridonic Driver - LC 60W 24V 0-10V Ip SNC UNV - 0-10Vdc
Dimming (5%) - 60W - 24Vdc - 120-277Vac - LED power supply

GENERAL

Division: Architectural

PHYSICAL

Length (mm): 148.2

Length (in): 5 ¹³/₁₆

Width (mm): 45.6

Width (in): 1 ¹³/₁₆

Height (mm): 25.4

Height (in): 1

Weight (kg): 0.335

Weight (lbs): 0.75

Fixture Material: Metal

ELECTRICAL

Lamp Type: LED

Input Wattage (W): 75

Total Output Wattage (W): 0-60

Dimming: 0-10V Dimming

Driver Type: Constant Voltage - Universal

Driver Class: Class 2

Housing: Outdoor - ENCP22

Input Voltage (V): 120 - 277

Output Voltage (V): 24

Constant Voltage (V): 24

RATINGS AND CERTIFICATIONS

Certified By: UL Listed

IP rating: Dry / Damp

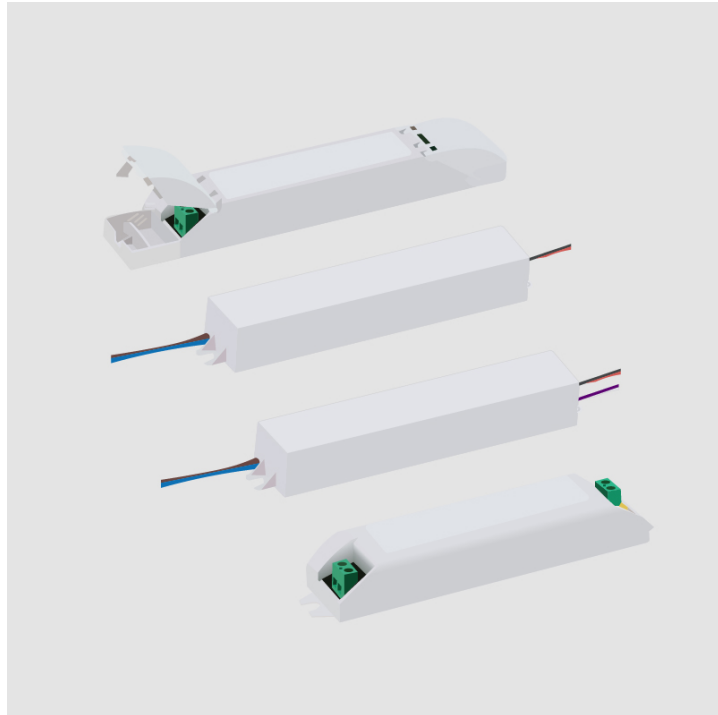

E9F432-HC- COMPONENTS

E9A02300

DESCRIPTION
IP68 gel connector - max 2 x 0,75 mm²

GENERAL

Partner: Platek
Division: Exterior

PHYSICAL

Diameter (mm): 4.8
Diameter (in): 3/16
Length (mm): 6
Length (in): 1/4
Fixture Finish: BLK
Fixture Material: Plastic

RATINGS AND CERTIFICATIONS

Certified By: CSA Certified to UL and CSA Standards

PROJECT	_____
TYPE	_____
NOTES	_____
QUANTITY	_____
DATE	_____



E9F432-HC- COMPONENTS

PROJECT	_____
TYPE	_____
NOTES	_____
QUANTITY	_____
DATE	_____

E9A12700

DESCRIPTION
 Connection to the pole (60 mm Ø)

GENERAL
 Partner: Platek
 Division: Exterior

PHYSICAL
 Fixture Material: Metal

RATINGS AND CERTIFICATIONS
 Certified By: Certified for North American Standards
 IP rating: IP65

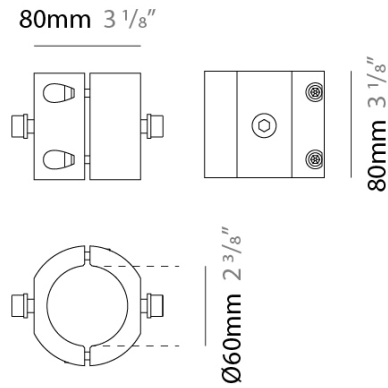

E9F432-HC- COMPONENTS

PROJECT	_____
TYPE	_____
NOTES	_____
QUANTITY	_____
DATE	_____

E9A12800

DESCRIPTION
 Connection to the pole (Ø 102mm)

GENERAL
 Partner: Platek
 Division: Exterior

PHYSICAL
 Fixture Material: Metal

RATINGS AND CERTIFICATIONS
 Certified By: Certified for North American Standards
 IP rating: IP65

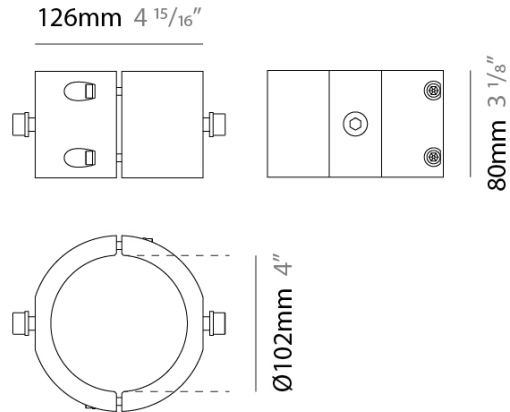

E9F432-HC- COMPONENTS

PROJECT	_____
TYPE	_____
NOTES	_____
QUANTITY	_____
DATE	_____

E9A12900

DESCRIPTION
 Connection to the pole (Ø 114mm)

GENERAL
 Partner: Platek
 Division: Exterior

PHYSICAL
 Fixture Material: Metal

RATINGS AND CERTIFICATIONS
 Certified By: Certified for North American Standards
 IP rating: IP65

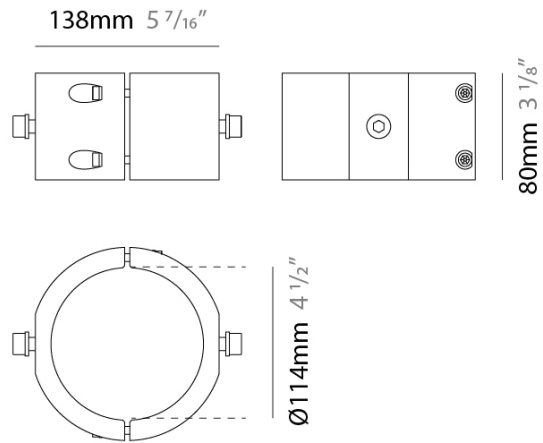

E9F432-HC- COMPONENTS

PROJECT	_____
TYPE	_____
NOTES	_____
QUANTITY	_____
DATE	_____

E9A18400

DESCRIPTION
Anchor belt - Accessory

GENERAL
Partner: Platek
Division: Exterior

RATINGS AND CERTIFICATIONS
Certified By: Certified for North American Standards
IP rating: IP65

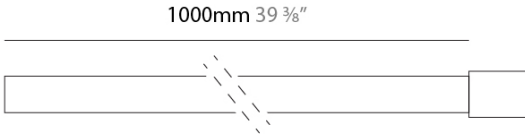

E9F432-HC- COMPONENTS

E9A25400

DESCRIPTION
IP68 Gel Connector for parallel connection - max. 4 x 1.5 mm²
Ø4.5 - 8.5 mm

GENERAL

Partner: Platek
Division: Exterior

PHYSICAL

Fixture Material: Plastic

RATINGS AND CERTIFICATIONS

Certified By: Certified for North American Standards
IP rating: IP65

PROJECT
TYPE
NOTES
QUANTITY
DATE



E9F432-HC- COMPONENTS

PROJECT	_____
TYPE	_____
NOTES	_____
QUANTITY	_____
DATE	_____

E9A50001

DESCRIPTION

Nano - 300mm - Aluminium rod with carbon finish and steel spike

GENERAL

Series: Nano _____
Partner: Platek _____
Division: Exterior _____

PHYSICAL

Fixture Material: Aluminum _____

RATINGS AND CERTIFICATIONS

Certified By: Certified for North American Standards _____
IP rating: IP65 _____

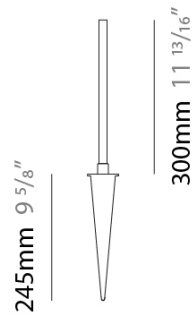

E9F432-HC- COMPONENTS

E9A50002

DESCRIPTION

Nano - 600mm - Aluminium rod with carbon finish and steel spike

GENERAL

Series: Nano

Partner: Platek

Division: Exterior

PHYSICAL

Fixture Material: Aluminum

RATINGS AND CERTIFICATIONS

Certified By: Certified for North American Standards

IP rating: IP65

PROJECT _____

TYPE _____

NOTES _____

QUANTITY _____

DATE _____

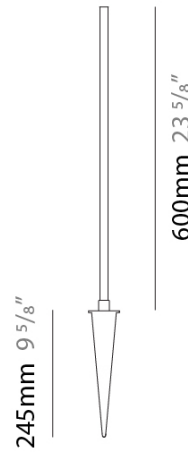

E9F432-HC- COMPONENTS

E9A50003

DESCRIPTION

Nano - 1100mm - Aluminium rod with carbon finish and steel spike

GENERAL

Series: Nano

Partner: Platek

Division: Exterior

PHYSICAL

Fixture Material: Aluminum

RATINGS AND CERTIFICATIONS

Certified By: Certified for North American Standards

IP rating: IP65

PROJECT _____

TYPE _____

NOTES _____

QUANTITY _____

DATE _____

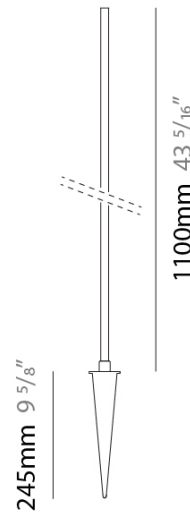

E9F432-HC- COMPONENTS

PROJECT	_____
TYPE	_____
NOTES	_____
QUANTITY	_____
DATE	_____

E9A50004

DESCRIPTION

Nano - 1700mm - Aluminium rod with carbon finish and steel spike

GENERAL

Series: Nano _____
Partner: Platek _____
Division: Exterior _____

PHYSICAL

Fixture Material: Aluminum _____

RATINGS AND CERTIFICATIONS

Certified By: Certified for North American Standards _____
IP rating: IP65 _____

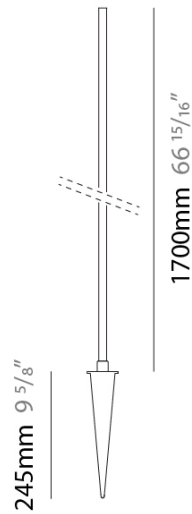

E9F432-HC- COMPONENTS

PROJECT	_____
TYPE	_____
NOTES	_____
QUANTITY	_____
DATE	_____

ENCP1

DESCRIPTION
 Empty Metal Enclosure for Driver - IP20 - Indoor Rated

GENERAL
 Division: Architectural : Components

PHYSICAL
 Shape: Rectangle
 Length (mm): 197
 Length (in): 7 ¾
 Width (mm): 41
 Width (in): 1 ⅝
 Height (mm): 41
 Height (in): 1 ⅝
 Screws: A4 stainless steel
 Fixture Material: Metal

RATINGS AND CERTIFICATIONS
 IP rating: IP20

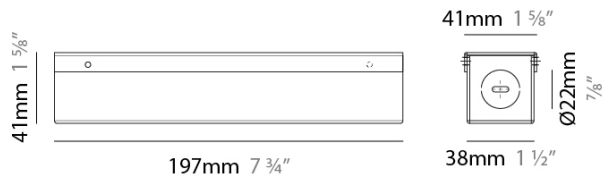

E9F432-HC- COMPONENTS

PROJECT	_____
TYPE	_____
NOTES	_____
QUANTITY	_____
DATE	_____

ENCP20

DESCRIPTION
 Polycarbonate - IP68 - Outdoor Rated - UL listed - Power Supply Enclosure in Light Gray

GENERAL
 Division: Architectural : Components _____

PHYSICAL
 Shape: Rectangle _____
 Length (mm): 160 _____
 Length (in): 6 ⁵/₁₆ _____
 Width (mm): 90 _____
 Width (in): 3 ⁹/₁₆ _____
 Height (mm): 61 _____
 Height (in): 2 ³/₈ _____
 Weight (kg): 0.24 _____
 Weight (lbs): 0.53 _____
 Screws: A4 stainless steel _____
 Gasket: 1554JGASKET _____
 Fixture Material: Plastic _____

RATINGS AND CERTIFICATIONS
 Certified By: UL Listed _____
 IP rating: IP68 _____

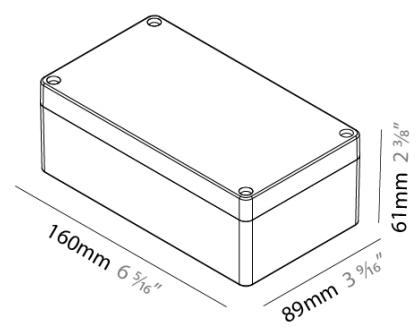

E9F432-HC- COMPONENTS

PROJECT _____
 TYPE _____
 NOTES _____
 QUANTITY _____
 DATE _____

ENCPC22

DESCRIPTION
 Polycarbonate - IP68 - Outdoor Rated - UL listed - Power Supply Enclosure in Light Gray

GENERAL
 Division: Architectural : Components _____

PHYSICAL
 Shape: Rectangle _____
 Length (mm): 238.8 _____
 Length (in): 9 ¹³/₃₂ _____
 Width (mm): 160 _____
 Width (in): 6 ⁵/₁₆ _____
 Height (mm): 60 _____
 Height (in): 2 ³/₈ _____
 Weight (kg): 0.51 _____
 Weight (lbs): 1.14 _____
 Screws: A4 stainless steel _____
 Gasket: 1554VAGASKET _____
 Fixture Material: Plastic _____

RATINGS AND CERTIFICATIONS
 Certified By: UL Listed _____
 IP rating: IP68 _____

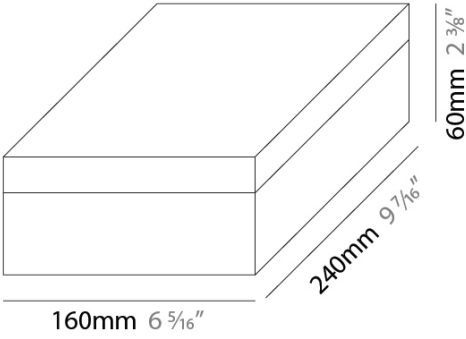

E9F432-HC- COMPONENTS

PROJECT	_____
TYPE	_____
NOTES	_____
QUANTITY	_____
DATE	_____

ENC3

DESCRIPTION
 Empty Metal Enclosure for Driver - IP20 - Indoor Rated

GENERAL
 Division: Architectural

PHYSICAL
 Shape: Rectangle
 Length (mm): 155
 Length (in): 6 1/8
 Width (mm): 54
 Width (in): 2 1/8
 Height (mm): 36
 Height (in): 1 3/8
 Screws: A4 stainless steel
 Fixture Material: Metal

RATINGS AND CERTIFICATIONS
 IP rating: IP20

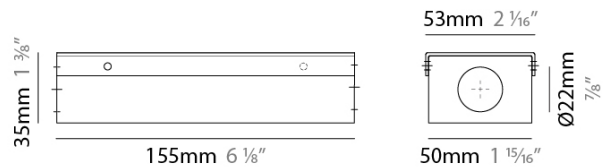

E9F432-HC- COMPONENTS

PROJECT	_____
TYPE	_____
NOTES	_____
QUANTITY	_____
DATE	_____

ENCP6

DESCRIPTION
 Empty Metal Enclosure for Driver - IP20 - Indoor Rated

GENERAL
 Division: Architectural : Components

PHYSICAL
 Shape: Rectangle
 Length (mm): 178
 Length (in): 7
 Width (mm): 105
 Width (in): 4 1/8
 Height (mm): 54
 Height (in): 2 1/8
 Screws: A4 stainless steel
 Fixture Material: Metal

RATINGS AND CERTIFICATIONS
 IP rating: IP20

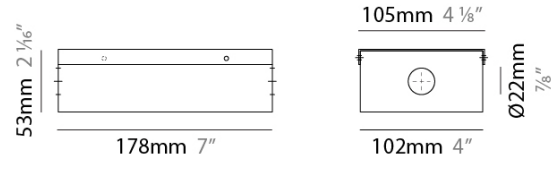

E9F432-HC- COMPONENTS

PROJECT	_____
TYPE	_____
NOTES	_____
QUANTITY	_____
DATE	_____

ENCP8

DESCRIPTION
 Empty Metal Enclosure for Driver - IP20 - Indoor Rated

GENERAL
 Division: Architectural : Components





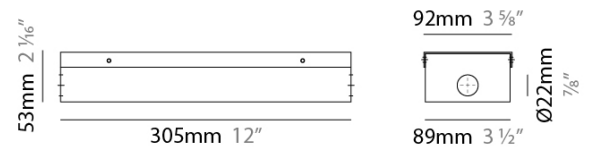































































PHYSICAL
 Shape: Rectangle
 Length (mm): 305
 Length (in): 12
 Width (mm): 92
 Width (in): 3 5/8
 Height (mm): 54
 Height (in): 2 1/8
 Fixture Material: Metal

RATINGS AND CERTIFICATIONS
 IP rating: IP20













PROJECT	_____
TYPE	_____
NOTES	_____
QUANTITY	_____
DATE	_____











LEGEND

 floor-mounted	 pivotable	 special LED (upon request) RGB, RGBW, tunable, gold+, meat+, art+, fashion+
 wall and ceiling: recessed and surface mounted	 rotating	 warm dim / natural dimming LED
 ceiling-mounted and wall-mounted	 illuminate tilted	 rechargeable battery powered
 wall-mounted	 color of suspension cable	 fixture with natural vivid LED (upon request)
 omni-directional light distribution	 length of suspension cable	 color rendering index
 direct light distribution	 reflector degree selection	 color temperature
 direct/indirect light distribution	 super spot	 lumen (luminous flux)
 indirect light distribution	 lens	 efficacy (lumens per watt)
 asymmetric light distribution	 lens pack	 Unified Glare Rating (UGR) range from 5-40
 aura light distribution	 shine ring	 marine grade (AISI 316 stainless steel)
 round wall or ceiling cut-out	 integrated shine ring with diffuser	 walk on
 square wall or ceiling cut-out	 free individual colors 01-29	 drive on
 the supplied jig specifies the cutout dimensions	 individual colors: 00 (free of charge), 01-25 (extra charge)	 Dark Sky Compliance
 minimum distance (meters) lamp - object	 luminaire part to be colored (F1)	 Americans with Disabilities Act (less than 4" off the wall located between 27"-84" from floor)
 recessed depth	 luminaire part to be colored (F2)	 lamp protected against explosion
 ceiling thickness in mm	 luminaire part to be colored (F3)	 blown glass using traditional methods by master glass blower
 ceiling thickness selection	 luminaire part to be colored (F4)	 acoustic material
 dimmable DP (phase), DV (0-10V), DD (dali), DS (step-dim)	 luminaire part to be colored (F5)	 protection class I, protection insulation
 included or excluded LED driver/transformer/control gear	 color of 3-circuit adaptor	 protection class II, protection insulation
 separately switchable	 indirect diffuser	 ETL Certified to UL and CSA Standards
 sensor	 direct diffuser	 UL Certified to UL and CSA Standards
 remote control	 ball-proof (upon request)	 CSA Certified to UL and CSA Standards
 available upon request	 accessory	 Certified for North American Standards

IP RATING

 IP20	protected against ingress of solid bodies greater than 12.5mm (finger)
 IP33	protected against ingress of solid bodies greater than 2.5mm protected against sprays of water up to 60 degrees from the vertical (rain)
 IP40	protected against ingress of solid bodies greater than 1mm (wire) no protection against the ingress of moisture
 IP43	protected against ingress of solid bodies greater than 1mm (wire) protected against sprays of water up to 60 degrees from the vertical (rain)
 IP44	protected against ingress of solid bodies greater than 1mm (wire) protected against water splashed from all directions
 IP54	protected against limited ingress of dust (wet rooms/covered outdoor areas) protected against water splashed from all directions
 IP65	protected against ingress of dust protected against jets of water
 IP66	protected against ingress of dust protected against powerful jets of water or heavy seas
 IP67	protected against ingress of dust protected against immersion of water between 15cm - 1m for 30 minutes
 IP68	protected against ingress of dust protected against immersion of water under pressure for long periods

IK RATING

 IK01	protected against 0.14 joules impact (equivalent to 0.25kg mass dropped from 56mm above the surface)
 IK02	protected against 0.2 joules impact (equivalent to 0.25kg mass dropped from 80mm above the surface)
 IK03	protected against 0.35 joules impact (equivalent to 0.25kg mass dropped from 140mm above the surface)
 IK04	protected against 0.5 joules impact (equivalent to 0.25kg mass dropped from 200mm above the surface)
 IK05	protected against 0.7 joules impact (equivalent to 0.25kg mass dropped from 280mm above the surface)
 IK06	protected against 1 joules impact (equivalent to 0.25kg mass dropped from 400mm above the surface)
 IK07	protected against 2 joules impact (equivalent to 0.5kg mass dropped from 400mm above the surface)
 IK08	protected against 5 joules impact (equivalent to 1.7kg mass dropped from 300mm above the surface)
 IK09	protected against 10 joules impact (equivalent to 5.0kg mass dropped from 200mm above the surface)
 IK10	protected against 20 joules impact (equivalent to 5.0kg mass dropped from 400mm above the surface)