

## E9F433-HC- COMPONENTS

PROJECT	_____
TYPE	_____
NOTES	_____
QUANTITY	_____
DATE	_____

### DVO0600024TLC

#### DESCRIPTION

Tridonic Driver - LC 60W 24V 0-10V Ip SNC UNV - 0-10Vdc  
Dimming (5%) - 60W - 24Vdc - 120-277Vac - LED power supply

#### GENERAL

Division: Architectural

#### PHYSICAL

Length (mm): 148.2

Length (in): 5 <sup>13</sup>/<sub>16</sub>

Width (mm): 45.6

Width (in): 1 <sup>13</sup>/<sub>16</sub>

Height (mm): 25.4

Height (in): 1

Weight (kg): 0.335

Weight (lbs): 0.75

Fixture Material: Metal

#### ELECTRICAL

Lamp Type: LED

Input Wattage (W): 75

Total Output Wattage (W): 0-60

Dimming: 0-10V Dimming

Driver Type: Constant Voltage - Universal

Driver Class: Class 2

Housing: Outdoor - ENCP22

Input Voltage (V): 120 - 277

Output Voltage (V): 24

Constant Voltage (V): 24

#### RATINGS AND CERTIFICATIONS

Certified By: UL Listed

IP rating: Dry / Damp

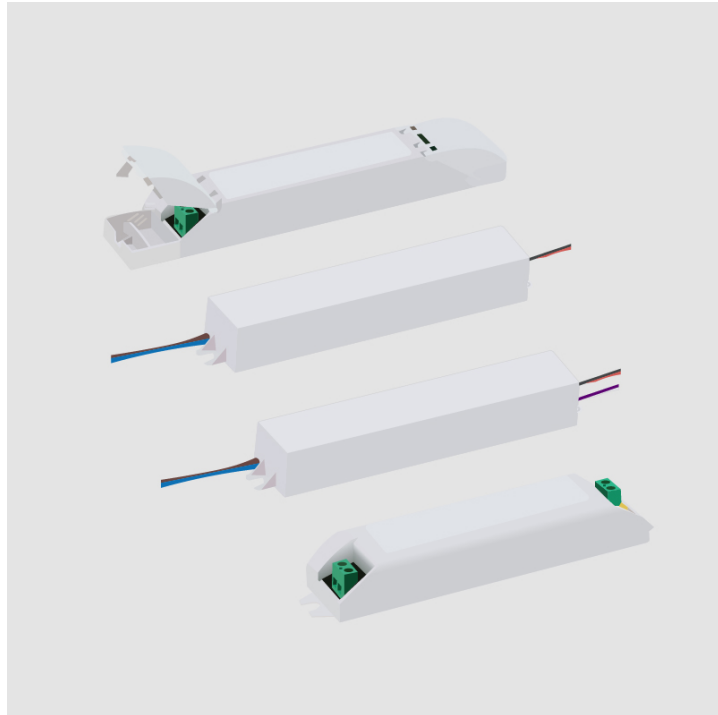

## E9F433-HC- COMPONENTS

### E9A02300

**DESCRIPTION**  
IP68 gel connector - max 2 x 0,75 mm^2

**GENERAL**

Partner: Platek  
Division: Exterior

**PHYSICAL**

Diameter (mm): 4.8  
Diameter (in): 3/16  
Length (mm): 6  
Length (in): 1/4  
Fixture Finish: BLK  
Fixture Material: Plastic

**RATINGS AND CERTIFICATIONS**

Certified By: CSA Certified to UL and CSA Standards

PROJECT	_____
TYPE	_____
NOTES	_____
QUANTITY	_____
DATE	_____



## E9F433-HC- COMPONENTS

PROJECT	_____
TYPE	_____
NOTES	_____
QUANTITY	_____
DATE	_____

### E9A18400

**DESCRIPTION**  
Anchor belt - Accessory

**GENERAL**  
Partner: Platek  
Division: Exterior

**RATINGS AND CERTIFICATIONS**  
Certified By: Certified for North American Standards  
IP rating: IP65

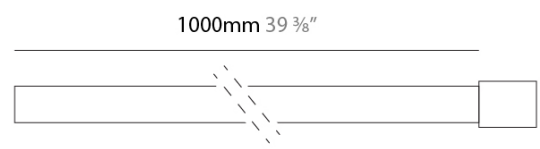

## E9F433-HC- COMPONENTS

### E9A25400

**DESCRIPTION**  
IP68 Gel Connector for parallel connection - max. 4 x 1.5 mm<sup>2</sup>  
Ø4.5 - 8.5 mm

**GENERAL**

Partner: Platek  
Division: Exterior

**PHYSICAL**

Fixture Material: Plastic

**RATINGS AND CERTIFICATIONS**

Certified By: Certified for North American Standards  
IP rating: IP65

PROJECT	_____
TYPE	_____
NOTES	_____
QUANTITY	_____
DATE	_____



## E9F433-HC- COMPONENTS

### E9A50103

**DESCRIPTION**  
Ring for tree application for Raygun 35, 50, 80

**GENERAL**  
Series: Raygun  
Partner: Platek  
Division: Exterior

**RATINGS AND CERTIFICATIONS**  
Certified By: Certified for North American Standards

PROJECT
TYPE
NOTES
QUANTITY
DATE



## E9F433-HC- COMPONENTS

PROJECT	_____
TYPE	_____
NOTES	_____
QUANTITY	_____
DATE	_____

### E9A50105

**DESCRIPTION**  
Raygun - 300mm/11 13/16" Stainless Steel Rod and Spike -  
Stainless Steel

**GENERAL**  
Series: Raygun \_\_\_\_\_  
Partner: Platek \_\_\_\_\_  
Division: Exterior \_\_\_\_\_

**PHYSICAL**  
Height (mm): 300 \_\_\_\_\_  
Height (in): 11 <sup>13</sup>/<sub>16</sub> \_\_\_\_\_  
Fixture Finish: SST \_\_\_\_\_  
Fixture Material: Stainless Steel \_\_\_\_\_  
Primary Material: Stainless Steel \_\_\_\_\_

**RATINGS AND CERTIFICATIONS**  
Certified By: Certified for North American Standards \_\_\_\_\_  
IP rating: IP65 \_\_\_\_\_

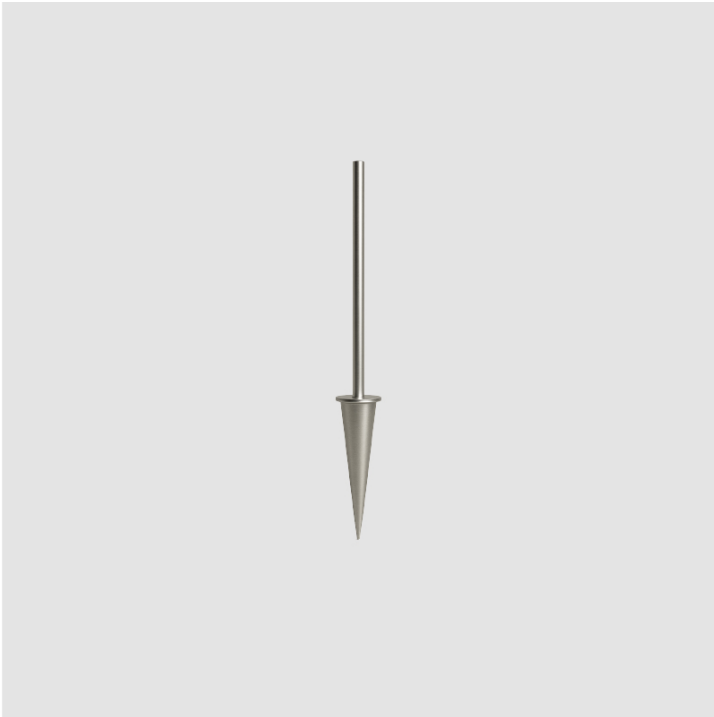

## E9F433-HC- COMPONENTS

PROJECT	_____
TYPE	_____
NOTES	_____
QUANTITY	_____
DATE	_____

### E9A50106

**DESCRIPTION**  
Raygun - 600mm/23 5/8" Stainless Steel Rod and Spike

**GENERAL**  
Series: Raygun  
Partner: Platek  
Division: Exterior

**PHYSICAL**  
Height (mm): 600  
Height (in): 23 5/8  
Fixture Material: Stainless Steel  
Primary Material: Stainless Steel

**RATINGS AND CERTIFICATIONS**  
Certified By: Certified for North American Standards  
IP rating: IP65



## E9F433-HC- COMPONENTS

PROJECT \_\_\_\_\_  
TYPE \_\_\_\_\_  
NOTES \_\_\_\_\_  
QUANTITY \_\_\_\_\_  
DATE \_\_\_\_\_

### E9A50107

**DESCRIPTION**  
Raygun - 1100mm/43 5/16" Stainless Steel Rod and Spike

**GENERAL**  
Series: Raygun \_\_\_\_\_  
Partner: Platek \_\_\_\_\_  
Division: Exterior \_\_\_\_\_

**PHYSICAL**  
Height (mm): 1100 \_\_\_\_\_  
Height (in): 43 5/16 \_\_\_\_\_  
Fixture Finish: SST \_\_\_\_\_  
Fixture Material: Stainless Steel \_\_\_\_\_  
Primary Material: Stainless Steel \_\_\_\_\_

**RATINGS AND CERTIFICATIONS**  
Certified By: Certified for North American Standards \_\_\_\_\_  
IP rating: IP65 \_\_\_\_\_



## E9F433-HC- COMPONENTS

### E9A50122

**DESCRIPTION**  
Raygun 80 Visor Stainless Steel

**GENERAL**  
Series: Raygun  
Partner: Platek  
Division: Exterior

**PHYSICAL**  
Diameter (mm): 80  
Diameter (in): 3 <sup>1</sup>/<sub>8</sub>  
Height (mm): 144  
Height (in): 5 <sup>13</sup>/<sub>16</sub>  
Fixture Finish: SST  
Fixture Material: Stainless Steel  
Primary Material: Stainless Steel

**RATINGS AND CERTIFICATIONS**  
Certified By: Certified for North American Standards

PROJECT	_____
TYPE	_____
NOTES	_____
QUANTITY	_____
DATE	_____



## E9F433-HC- COMPONENTS

PROJECT	_____
TYPE	_____
NOTES	_____
QUANTITY	_____
DATE	_____

### E9A50123

**DESCRIPTION**  
Raygun 80 Cylindrical Screen Stainless Steel

**GENERAL**  
Series: Raygun  
Partner: Platek  
Division: Exterior

**PHYSICAL**  
Diameter (mm): 80  
Diameter (in): 3 <sup>1</sup>/<sub>8</sub>  
Height (mm): 144  
Height (in): 5 <sup>13</sup>/<sub>16</sub>  
Fixture Finish: SST  
Fixture Material: Stainless Steel  
Primary Material: Stainless Steel

**RATINGS AND CERTIFICATIONS**  
Certified By: Certified for North American Standards  
IP rating: IP65



## E9F433-HC- COMPONENTS

PROJECT	_____
TYPE	_____
NOTES	_____
QUANTITY	_____
DATE	_____

### ENCP1

**DESCRIPTION**  
 Empty Metal Enclosure for Driver - IP20 - Indoor Rated

**GENERAL**  
 Division: Architectural : Components

**PHYSICAL**  
 Shape: Rectangle  
 Length (mm): 197  
 Length (in): 7 ¾  
 Width (mm): 41  
 Width (in): 1 ⅝  
 Height (mm): 41  
 Height (in): 1 ⅝  
 Screws: A4 stainless steel  
 Fixture Material: Metal

**RATINGS AND CERTIFICATIONS**  
 IP rating: IP20

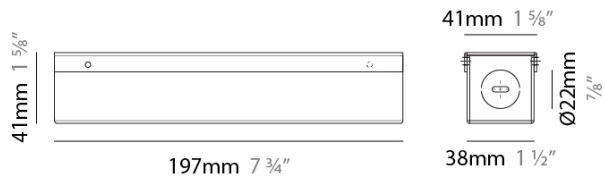

## E9F433-HC- COMPONENTS

PROJECT	_____
TYPE	_____
NOTES	_____
QUANTITY	_____
DATE	_____

### ENCP20

**DESCRIPTION**  
Polycarbonate - IP68 - Outdoor Rated - UL listed - Power Supply Enclosure in Light Gray

**GENERAL**  
Division: Architectural : Components

**PHYSICAL**  
Shape: Rectangle  
Length (mm): 160  
Length (in): 6 <sup>5</sup>/<sub>16</sub>  
Width (mm): 90  
Width (in): 3 <sup>9</sup>/<sub>16</sub>  
Height (mm): 61  
Height (in): 2 <sup>3</sup>/<sub>8</sub>  
Weight (kg): 0.24  
Weight (lbs): 0.53  
Screws: A4 stainless steel  
Gasket: 1554JGASKET  
Fixture Material: Plastic

**RATINGS AND CERTIFICATIONS**  
Certified By: UL Listed  
IP rating: IP68

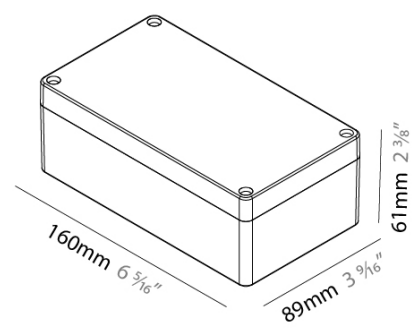

## E9F433-HC- COMPONENTS

PROJECT	_____
TYPE	_____
NOTES	_____
QUANTITY	_____
DATE	_____

### ENCPC22

**DESCRIPTION**  
 Polycarbonate - IP68 - Outdoor Rated - UL listed - Power Supply Enclosure in Light Gray

**GENERAL**  
 Division: Architectural : Components \_\_\_\_\_

**PHYSICAL**  
 Shape: Rectangle \_\_\_\_\_  
 Length (mm): 238.8 \_\_\_\_\_  
 Length (in): 9 <sup>13</sup>/<sub>32</sub> \_\_\_\_\_  
 Width (mm): 160 \_\_\_\_\_  
 Width (in): 6 <sup>5</sup>/<sub>16</sub> \_\_\_\_\_  
 Height (mm): 60 \_\_\_\_\_  
 Height (in): 2 <sup>3</sup>/<sub>8</sub> \_\_\_\_\_  
 Weight (kg): 0.51 \_\_\_\_\_  
 Weight (lbs): 1.14 \_\_\_\_\_  
 Screws: A4 stainless steel \_\_\_\_\_  
 Gasket: 1554VAGASKET \_\_\_\_\_  
 Fixture Material: Plastic \_\_\_\_\_

**RATINGS AND CERTIFICATIONS**  
 Certified By: UL Listed \_\_\_\_\_  
 IP rating: IP68 \_\_\_\_\_

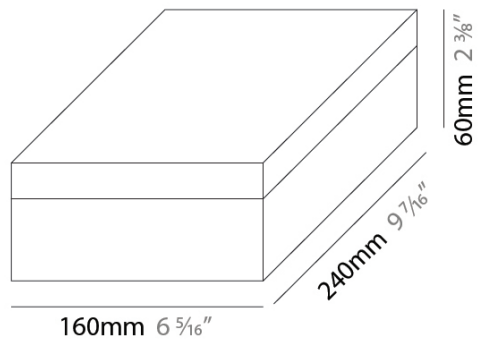

## E9F433-HC- COMPONENTS

PROJECT	_____
TYPE	_____
NOTES	_____
QUANTITY	_____
DATE	_____

### ENC3

**DESCRIPTION**  
Empty Metal Enclosure for Driver - IP20 - Indoor Rated

**GENERAL**  
Division: Architectural

**PHYSICAL**  
Shape: Rectangle  
Length (mm): 155  
Length (in): 6 1/8  
Width (mm): 54  
Width (in): 2 1/8  
Height (mm): 36  
Height (in): 1 3/8  
Screws: A4 stainless steel  
Fixture Material: Metal

**RATINGS AND CERTIFICATIONS**  
IP rating: IP20

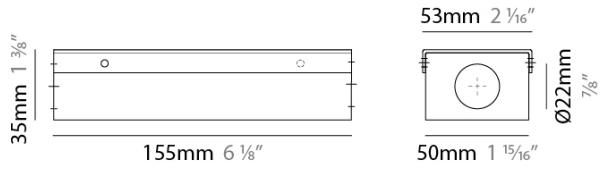

## E9F433-HC- COMPONENTS

PROJECT	_____
TYPE	_____
NOTES	_____
QUANTITY	_____
DATE	_____

### ENCP6

**DESCRIPTION**  
 Empty Metal Enclosure for Driver - IP20 - Indoor Rated

**GENERAL**  
 Division: Architectural : Components

**PHYSICAL**  
 Shape: Rectangle  
 Length (mm): 178  
 Length (in): 7  
 Width (mm): 105  
 Width (in): 4 1/8  
 Height (mm): 54  
 Height (in): 2 1/8  
 Screws: A4 stainless steel  
 Fixture Material: Metal

**RATINGS AND CERTIFICATIONS**  
 IP rating: IP20

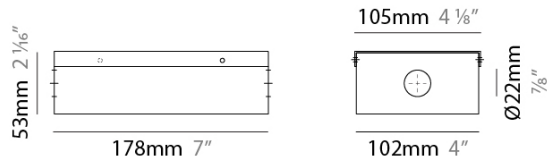

## E9F433-HC- COMPONENTS

PROJECT	_____
TYPE	_____
NOTES	_____
QUANTITY	_____
DATE	_____

### ENCPS8

**DESCRIPTION**  
 Empty Metal Enclosure for Driver - IP20 - Indoor Rated

**GENERAL**  
 Division: Architectural : Components

**PHYSICAL**  
 Shape: Rectangle  
 Length (mm): 305  
 Length (in): 12  
 Width (mm): 92  
 Width (in): 3 5/8  
 Height (mm): 54  
 Height (in): 2 1/8  
 Fixture Material: Metal

**RATINGS AND CERTIFICATIONS**  
 IP rating: IP20

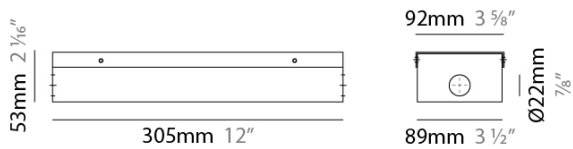

PROJECT \_\_\_\_\_





































































TYPE \_\_\_\_\_

NOTES \_\_\_\_\_











QUANTITY \_\_\_\_\_

DATE \_\_\_\_\_











### LEGEND

	floor-mounted		pivotal		special LED (upon request) RGB, RGBW, tunable, gold+, meat+, art+, fashion+
	wall and ceiling: recessed and surface mounted		rotating		warm dim / natural dimming LED
	ceiling-mounted and wall-mounted		illuminate tilted		rechargeable battery powered
	wall-mounted		color of suspension cable		fixture with natural vivid LED (upon request)
	omni-directional light distribution		length of suspension cable		color rendering index
	direct light distribution		reflector degree selection		color temperature
	direct/indirect light distribution		super spot		lumen (luminous flux)
	indirect light distribution		lens		efficacy (lumens per watt)
	asymmetric light distribution		lens pack		Unified Glare Rating (UGR) range from 5-40
	aura light distribution		shine ring		marine grade (AISI 316 stainless steel)
	round wall or ceiling cut-out		integrated shine ring with diffuser		walk on
	square wall or ceiling cut-out		free individual colors 01-29		drive on
	the supplied jig specifies the cutout dimensions		individual colors: 00 (free of charge), 01-25 (extra charge)		Dark Sky Compliance
	minimum distance (meters) lamp - object		luminaire part to be colored (F1)		Americans with Disabilities Act (less than 4" off the wall located between 27"-84" from floor)
	recessed depth		luminaire part to be colored (F2)		lamp protected against explosion
	ceiling thickness in mm		luminaire part to be colored (F3)		blown glass using traditional methods by master glass blower
	ceiling thickness selection		luminaire part to be colored (F4)		acoustic material
	dimnable DP (phase), DV (0-10V), DD (dali), DS (step-dim)		luminaire part to be colored (F5)		protection class I, protection insulation
	included or excluded LED driver/transformer/control gear		color of 3-circuit adaptor		protection class II, protection insulation
	separately switchable		indirect diffuser		ETL Certified to UL and CSA Standards
	sensor		direct diffuser		UL Certified to UL and CSA Standards
	remote control		ball-proof (upon request)		CSA Certified to UL and CSA Standards
	available upon request		accessory		Certified for North American Standards

### IP RATING

	protected against ingress of solid bodies greater than 12.5mm (finger)
	protected against ingress of solid bodies greater than 2.5mm protected against sprays of water up to 60 degrees from the vertical (rain)
	protected against ingress of solid bodies greater than 1mm (wire) no protection against the ingress of moisture
	protected against ingress of solid bodies greater than 1mm (wire) protected against sprays of water up to 60 degrees from the vertical (rain)
	protected against ingress of solid bodies greater than 1mm (wire) protected against water splashed from all directions
	protected against limited ingress of dust (wet rooms/covered outdoor areas) protected against water splashed from all directions
	protected against ingress of dust protected against jets of water
	protected against ingress of dust protected against powerful jets of water or heavy seas
	protected against ingress of dust protected against immersion of water between 15cm - 1m for 30 minutes
	protected against ingress of dust protected against immersion of water under pressure for long periods

### IK RATING

	protected against 0.14 joules impact (equivalent to 0.25kg mass dropped from 56mm above the surface)
	protected against 0.2 joules impact (equivalent to 0.25kg mass dropped from 80mm above the surface)
	protected against 0.35 joules impact (equivalent to 0.25kg mass dropped from 140mm above the surface)
	protected against 0.5 joules impact (equivalent to 0.25kg mass dropped from 200mm above the surface)
	protected against 0.7 joules impact (equivalent to 0.25kg mass dropped from 280mm above the surface)
	protected against 1 joules impact (equivalent to 0.25kg mass dropped from 400mm above the surface)
	protected against 2 joules impact (equivalent to 0.5kg mass dropped from 400mm above the surface)
	protected against 5 joules impact (equivalent to 1.7kg mass dropped from 300mm above the surface)
	protected against 10 joules impact (equivalent to 5.0kg mass dropped from 200mm above the surface)
	protected against 20 joules impact (equivalent to 5.0kg mass dropped from 400mm above the surface)