

E9F434-HC- COMPONENTS

PROJECT	_____
TYPE	_____
NOTES	_____
QUANTITY	_____
DATE	_____

DVO0600024TLC

DESCRIPTION

Tridonic Driver - LC 60W 24V 0-10V Ip SNC UNV - 0-10Vdc
Dimming (5%) - 60W - 24Vdc - 120-277Vac - LED power supply

GENERAL

Division: Architectural

PHYSICAL

Length (mm): 148.2

Length (in): 5 ¹³/₁₆

Width (mm): 45.6

Width (in): 1 ¹³/₁₆

Height (mm): 25.4

Height (in): 1

Weight (kg): 0.335

Weight (lbs): 0.75

Fixture Material: Metal

ELECTRICAL

Lamp Type: LED

Input Wattage (W): 75

Total Output Wattage (W): 0-60

Dimming: 0-10V Dimming

Driver Type: Constant Voltage - Universal

Driver Class: Class 2

Housing: Outdoor - ENCP22

Input Voltage (V): 120 - 277

Output Voltage (V): 24

Constant Voltage (V): 24

RATINGS AND CERTIFICATIONS

Certified By: UL Listed

IP rating: Dry / Damp

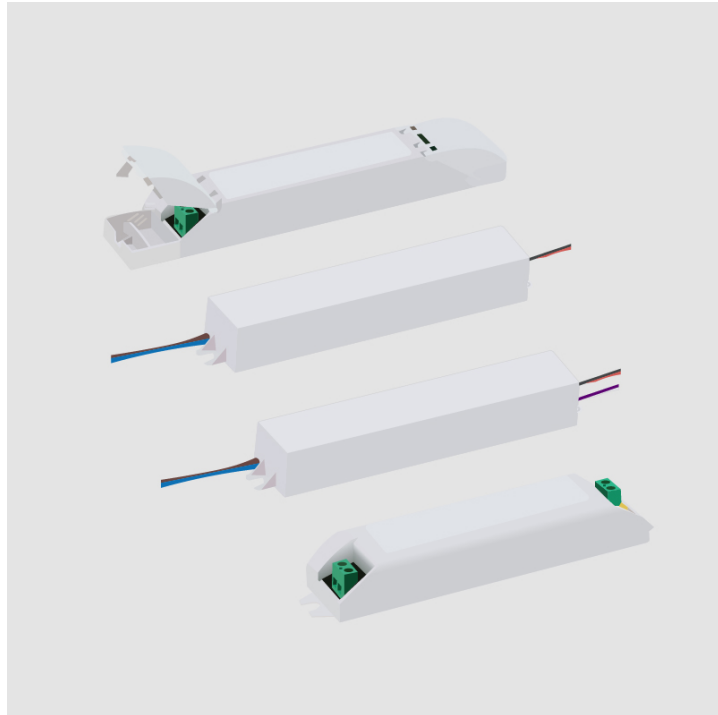

E9F434-HC- COMPONENTS

E9A02300

DESCRIPTION
IP68 gel connector - max 2 x 0,75 mm²

GENERAL

Partner: Platek
Division: Exterior

PHYSICAL

Diameter (mm): 4.8
Diameter (in): 3/16
Length (mm): 6
Length (in): 1/4
Fixture Finish: BLK
Fixture Material: Plastic

RATINGS AND CERTIFICATIONS

Certified By: CSA Certified to UL and CSA Standards

PROJECT
TYPE
NOTES
QUANTITY
DATE



E9F434-HC- COMPONENTS

PROJECT	_____
TYPE	_____
NOTES	_____
QUANTITY	_____
DATE	_____

E9A18400

DESCRIPTION
Anchor belt - Accessory

GENERAL
Partner: Platek
Division: Exterior

RATINGS AND CERTIFICATIONS
Certified By: Certified for North American Standards
IP rating: IP65

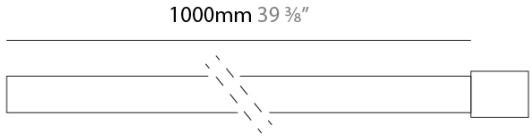

E9F434-HC- COMPONENTS

E9A25400

DESCRIPTION
IP68 Gel Connector for parallel connection - max. 4 x 1.5 mm²
Ø4.5 - 8.5 mm

GENERAL

Partner: Platek
Division: Exterior

PHYSICAL

Fixture Material: Plastic

RATINGS AND CERTIFICATIONS

Certified By: Certified for North American Standards
IP rating: IP65

PROJECT _____
TYPE _____
NOTES _____
QUANTITY _____
DATE _____



E9F434-HC- COMPONENTS

E9A50103

DESCRIPTION
Ring for tree application for Raygun 35, 50, 80

GENERAL
Series: Raygun
Partner: Platek
Division: Exterior

RATINGS AND CERTIFICATIONS
Certified By: Certified for North American Standards

PROJECT
TYPE
NOTES
QUANTITY
DATE



E9F434-HC- COMPONENTS

PROJECT	_____
TYPE	_____
NOTES	_____
QUANTITY	_____
DATE	_____

E9A50109

DESCRIPTION
Raygun 35, Visor Surfshield

GENERAL
Series: Raygun
Partner: Platek
Division: Exterior

PHYSICAL
Diameter (mm): 35
Diameter (in): 1 3/8
Height (mm): 66
Height (in): 2 5/8
Fixture Finish: SFS
Fixture Material: Stainless Steel
Primary Material: Stainless Steel

RATINGS AND CERTIFICATIONS
Certified By: Certified for North American Standards



E9F434-HC- COMPONENTS

PROJECT	_____
TYPE	_____
NOTES	_____
QUANTITY	_____
DATE	_____

E9A50110

DESCRIPTION
Raygun 35, Cylindrical Screen Surfshield

GENERAL
Series: Raygun
Partner: Platek
Division: Exterior

PHYSICAL
Diameter (mm): 35
Diameter (in): 1 3/8
Height (mm): 66
Height (in): 2 5/8
Fixture Finish: SFS
Fixture Material: Stainless Steel
Primary Material: Stainless Steel

RATINGS AND CERTIFICATIONS
Certified By: Certified for North American Standards
IP rating: IP65



E9F434-HC- COMPONENTS

E9A50111

DESCRIPTION
Raygun - 300mm/11 13/16" Stainless Steel Rod and Spike - Surfshield

GENERAL
Series: Raygun
Partner: Platek
Division: Exterior

PHYSICAL
Height (mm): 300
Height (in): 11 13/16
Fixture Finish: SFS
Fixture Material: Stainless Steel
Primary Material: Stainless Steel

RATINGS AND CERTIFICATIONS
Certified By: Certified for North American Standards
IP rating: IP65

PROJECT _____
TYPE _____
NOTES _____
QUANTITY _____
DATE _____



E9F434-HC- COMPONENTS

PROJECT	_____
TYPE	_____
NOTES	_____
QUANTITY	_____
DATE	_____

E9A50126

DESCRIPTION
Raygun 80 Visor Surfshield

GENERAL
Series: Raygun
Partner: Platek
Division: Exterior

PHYSICAL
Diameter (mm): 80
Diameter (in): 3 ¹/₈
Height (mm): 144
Height (in): 5 ¹³/₁₆
Fixture Finish: SFS
Fixture Material: Stainless Steel
Primary Material: Stainless Steel

RATINGS AND CERTIFICATIONS
Certified By: Certified for North American Standards



E9F434-HC- COMPONENTS

PROJECT _____
TYPE _____
NOTES _____
QUANTITY _____
DATE _____

E9A50127

DESCRIPTION
Raygun 80 Cylindrical Screen Surfshield

GENERAL
Series: Raygun
Partner: Platek
Division: Exterior

PHYSICAL
Diameter (mm): 80
Diameter (in): 3 1/8
Height (mm): 144
Height (in): 5 13/16
Fixture Finish: SFS
Fixture Material: Stainless Steel
Primary Material: Stainless Steel

RATINGS AND CERTIFICATIONS
Certified By: Certified for North American Standards
IP rating: IP65



E9F434-HC- COMPONENTS

PROJECT	_____
TYPE	_____
NOTES	_____
QUANTITY	_____
DATE	_____

ENCP1

DESCRIPTION
 Empty Metal Enclosure for Driver - IP20 - Indoor Rated

GENERAL
 Division: Architectural : Components

PHYSICAL
 Shape: Rectangle
 Length (mm): 197
 Length (in): 7 ¾
 Width (mm): 41
 Width (in): 1 ⅝
 Height (mm): 41
 Height (in): 1 ⅝
 Screws: A4 stainless steel
 Fixture Material: Metal

RATINGS AND CERTIFICATIONS
 IP rating: IP20

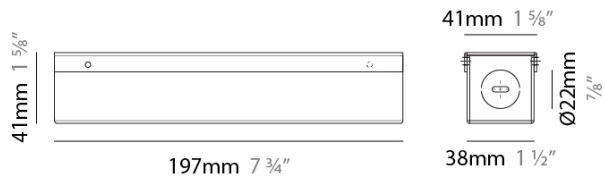

E9F434-HC- COMPONENTS

PROJECT	_____
TYPE	_____
NOTES	_____
QUANTITY	_____
DATE	_____

ENCP20

DESCRIPTION
 Polycarbonate - IP68 - Outdoor Rated - UL listed - Power Supply Enclosure in Light Gray

GENERAL
 Division: Architectural : Components _____

PHYSICAL
 Shape: Rectangle _____
 Length (mm): 160 _____
 Length (in): 6 ⁵/₁₆ _____
 Width (mm): 90 _____
 Width (in): 3 ⁹/₁₆ _____
 Height (mm): 61 _____
 Height (in): 2 ³/₈ _____
 Weight (kg): 0.24 _____
 Weight (lbs): 0.53 _____
 Screws: A4 stainless steel _____
 Gasket: 1554JGASKET _____
 Fixture Material: Plastic _____

RATINGS AND CERTIFICATIONS
 Certified By: UL Listed _____
 IP rating: IP68 _____

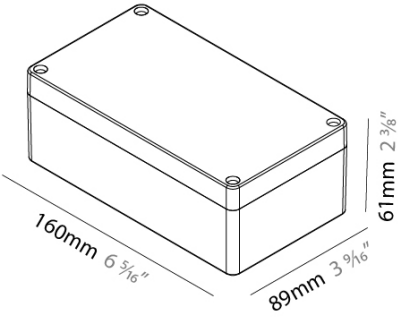

E9F434-HC- COMPONENTS

PROJECT	_____
TYPE	_____
NOTES	_____
QUANTITY	_____
DATE	_____

ENCPC22

DESCRIPTION
 Polycarbonate - IP68 - Outdoor Rated - UL listed - Power Supply Enclosure in Light Gray

GENERAL
 Division: Architectural : Components

PHYSICAL
 Shape: Rectangle
 Length (mm): 238.8
 Length (in): 9 ¹³/₃₂
 Width (mm): 160
 Width (in): 6 ⁵/₁₆
 Height (mm): 60
 Height (in): 2 ³/₈
 Weight (kg): 0.51
 Weight (lbs): 1.14
 Screws: A4 stainless steel
 Gasket: 1554VAGASKET
 Fixture Material: Plastic

RATINGS AND CERTIFICATIONS
 Certified By: UL Listed
 IP rating: IP68

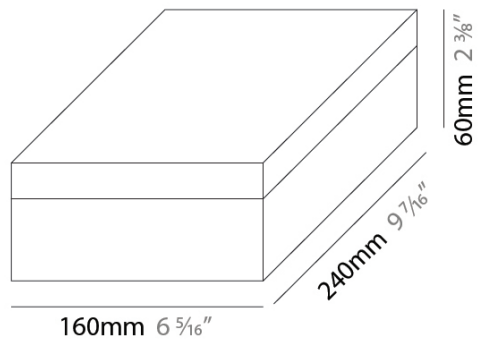

E9F434-HC- COMPONENTS

PROJECT	_____
TYPE	_____
NOTES	_____
QUANTITY	_____
DATE	_____

ENC3

DESCRIPTION
 Empty Metal Enclosure for Driver - IP20 - Indoor Rated

GENERAL
 Division: Architectural

PHYSICAL
 Shape: Rectangle
 Length (mm): 155
 Length (in): 6 1/8
 Width (mm): 54
 Width (in): 2 1/8
 Height (mm): 36
 Height (in): 1 3/8
 Screws: A4 stainless steel
 Fixture Material: Metal

RATINGS AND CERTIFICATIONS
 IP rating: IP20

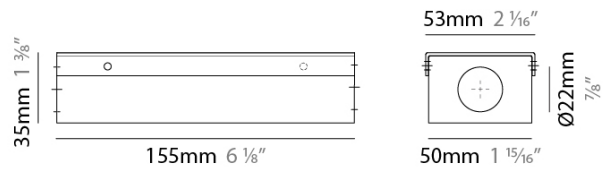

E9F434-HC- COMPONENTS

PROJECT	_____
TYPE	_____
NOTES	_____
QUANTITY	_____
DATE	_____

ENCP6

DESCRIPTION
 Empty Metal Enclosure for Driver - IP20 - Indoor Rated

GENERAL
 Division: Architectural : Components

PHYSICAL
 Shape: Rectangle
 Length (mm): 178
 Length (in): 7
 Width (mm): 105
 Width (in): 4 1/8
 Height (mm): 54
 Height (in): 2 1/8
 Screws: A4 stainless steel
 Fixture Material: Metal

RATINGS AND CERTIFICATIONS
 IP rating: IP20

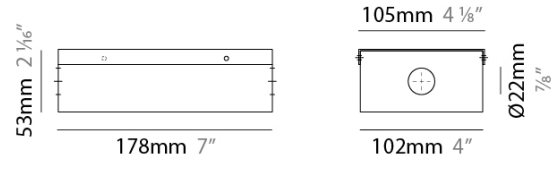

E9F434-HC- COMPONENTS

PROJECT	_____
TYPE	_____
NOTES	_____
QUANTITY	_____
DATE	_____

ENCP8

DESCRIPTION
 Empty Metal Enclosure for Driver - IP20 - Indoor Rated

GENERAL
 Division: Architectural : Components





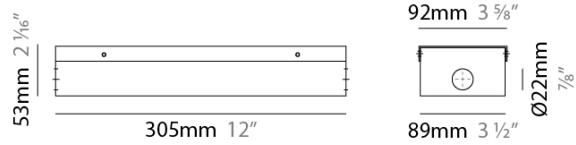































































PHYSICAL
 Shape: Rectangle
 Length (mm): 305
 Length (in): 12
 Width (mm): 92
 Width (in): 3 5/8
 Height (mm): 54
 Height (in): 2 1/8
 Fixture Material: Metal

RATINGS AND CERTIFICATIONS
 IP rating: IP20













PROJECT	_____
TYPE	_____
NOTES	_____
QUANTITY	_____
DATE	_____











LEGEND

	floor-mounted		pivotal		special LED (upon request) RGB, RGBW, tunable, gold+, meat+, art+, fashion+
	wall and ceiling: recessed and surface mounted		rotating		warm dim / natural dimming LED
	ceiling-mounted and wall-mounted		illuminate tilted		rechargeable battery powered
	wall-mounted		color of suspension cable		fixture with natural vivid LED (upon request)
	omni-directional light distribution		length of suspension cable		color rendering index
	direct light distribution		reflector degree selection		color temperature
	direct/indirect light distribution		super spot		lumen (luminous flux)
	indirect light distribution		lens		efficacy (lumens per watt)
	asymmetric light distribution		lens pack		Unified Glare Rating (UGR) range from 5-40
	aura light distribution		shine ring		marine grade (AISI 316 stainless steel)
	round wall or ceiling cut-out		integrated shine ring with diffuser		walk on
	square wall or ceiling cut-out		free individual colors 01-29		drive on
	the supplied jig specifies the cutout dimensions		individual colors: 00 (free of charge), 01-25 (extra charge)		Dark Sky Compliance
	minimum distance (meters) lamp - object		luminaire part to be colored (F1)		Americans with Disabilities Act (less than 4" off the wall located between 27"-84" from floor)
	recessed depth		luminaire part to be colored (F2)		lamp protected against explosion
	ceiling thickness in mm		luminaire part to be colored (F3)		blown glass using traditional methods by master glass blower
	ceiling thickness selection		luminaire part to be colored (F4)		acoustic material
	dimmable DP (phase), DV (0-10V), DD (dali), DS (step-dim)		luminaire part to be colored (F5)		protection class I, protection insulation
	included or excluded LED driver/transformer/control gear		color of 3-circuit adaptor		protection class II, protection insulation
	separately switchable		indirect diffuser		ETL Certified to UL and CSA Standards
	sensor		direct diffuser		UL Certified to UL and CSA Standards
	remote control		ball-proof (upon request)		CSA Certified to UL and CSA Standards
	available upon request		accessory		Certified for North American Standards

IP RATING

	protected against ingress of solid bodies greater than 12.5mm (finger)
	protected against ingress of solid bodies greater than 2.5mm protected against sprays of water up to 60 degrees from the vertical (rain)
	protected against ingress of solid bodies greater than 1mm (wire) no protection against the ingress of moisture
	protected against ingress of solid bodies greater than 1mm (wire) protected against sprays of water up to 60 degrees from the vertical (rain)
	protected against ingress of solid bodies greater than 1mm (wire) protected against water splashed from all directions
	protected against limited ingress of dust (wet rooms/covered outdoor areas) protected against water splashed from all directions
	protected against ingress of dust protected against jets of water
	protected against ingress of dust protected against powerful jets of water or heavy seas
	protected against ingress of dust protected against immersion of water between 15cm - 1m for 30 minutes
	protected against ingress of dust protected against immersion of water under pressure for long periods

IK RATING

	protected against 0.14 joules impact (equivalent to 0.25kg mass dropped from 56mm above the surface)
	protected against 0.2 joules impact (equivalent to 0.25kg mass dropped from 80mm above the surface)
	protected against 0.35 joules impact (equivalent to 0.25kg mass dropped from 140mm above the surface)
	protected against 0.5 joules impact (equivalent to 0.25kg mass dropped from 200mm above the surface)
	protected against 0.7 joules impact (equivalent to 0.25kg mass dropped from 280mm above the surface)
	protected against 1 joules impact (equivalent to 0.25kg mass dropped from 400mm above the surface)
	protected against 2 joules impact (equivalent to 0.5kg mass dropped from 400mm above the surface)
	protected against 5 joules impact (equivalent to 1.7kg mass dropped from 300mm above the surface)
	protected against 10 joules impact (equivalent to 5.0kg mass dropped from 200mm above the surface)
	protected against 20 joules impact (equivalent to 5.0kg mass dropped from 400mm above the surface)