

PROJECT
TYPE
SPECIFIER
QUANTITY
DATE

## SILEZZ SUSPENSION

### A3001051-

base number	Color Temperature	Finishes (Diamond)	Finishes (Circle)	Finishes (Triangle)	Acoustic Options	Cable Length and Finish	Diffuser Options
-------------	-------------------	--------------------	-------------------	---------------------	------------------	-------------------------	------------------

- To build a product code in our configurator select the specify button on the base model # product page
- To build a manual product code on this datasheet choose from the options listed below in blue font and add the suffix to the base model #

#### GENERAL

Series: Silenzz
Partner: Prolicht
Division: Architectural
Installation: Suspension
Product Type: Acoustic
Mounting Location: Ceiling
Light Distribution: Direct

#### PHYSICAL

Shape: Cone
Diameter (mm): 560
Diameter (in): 22 1/8"
Height (mm): 360
Height (in): 14 1/8"
Weight (kg): 4.0
Diffuser: <a href="#">Clear / Microprism / Clear Microprism</a>
Fixture Finish: <a href="#">SSR / BKV / CWI / CRY / HAB / UFT / ITA / RUA / FTG / MYG / LOD / PUS / FRO / FUP / KIA / POP / BLS / SPG / MEY / GOH / CHC / COM / ABZ / JAG / OBR / MOS / ROR</a>
Holder Finish: <a href="#">SSR / BKV / CWI / CRY / HAB / LAG / UFT / ITA / RUA / RUR / MIC / FTG / MYG / TWT / LOD / PUS / FRO / FUP / KIA / POP / BLS / SPG / MEY / GOH / GUM / CHC / COM / ABZ / JAG</a>
Acoustic Finish: <a href="#">SFW / CYW / SEE / SYN / MTS / PMB / TTN / CYB / STO / DPE / BES / SHB / ARE / ANE / VRD / CRF</a>
Fixture Material: Acoustic
Primary Material: Acoustic
Cable Details: <a href="#">2000mm/78 3/4" or 6000mm/236 1/4" Cable, - Black, Orange, Red, Transparent and White</a>

#### ELECTRICAL

Lamp Type: LED
Input Wattage (W): 26
Total Output Wattage (W): 23.6
Dimming: <a href="#">Tri-Mode (Non-Dimming and Phase Dimming (120Vac only) and 0-10V Dimming)</a>
Driver Included: Yes
Driver Location: Integrated
Driver Type: <a href="#">Constant Current - Universal</a>
Driver Class: <a href="#">Class 2</a>
Input Voltage (V): <a href="#">120 - 277</a>
Constant Current (mA): <a href="#">700mA</a>
Upon Request: <a href="#">MATTER Dimming / DALI Dimming (Remote)</a>

#### LED

Color Temperature (°K): <a href="#">2700 / 3000 / 3500 / 4000</a>
Max. Delivered Lumen (lm): <a href="#">Max 3555</a>
CRI: <a href="#">&gt;90 CRI</a>
Lamp Life (hrs): <a href="#">50000</a>

#### RATINGS AND CERTIFICATIONS

Certified By: <a href="#">Certified for North American Standards</a>
IP rating: <a href="#">IP20</a>

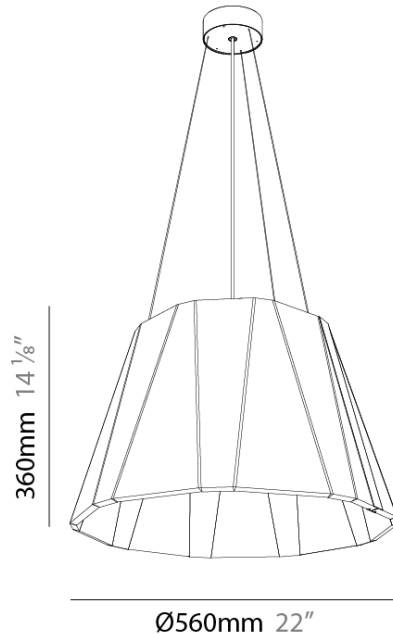

A3001051-

PROJECT \_\_\_\_\_

TYPE \_\_\_\_\_

SPECIFIER \_\_\_\_\_

QUANTITY \_\_\_\_\_

DATE \_\_\_\_\_

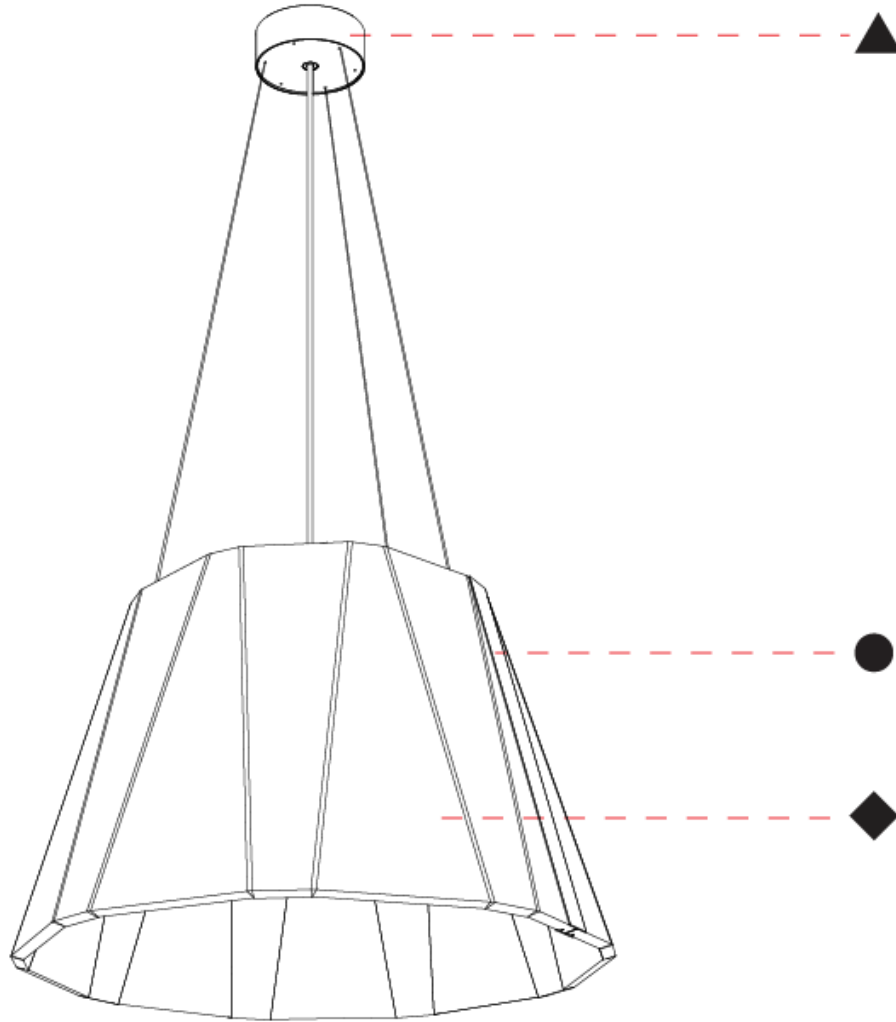

A

## MAINTENANCE FACTOR

Service life	10 000 h	20 000 h	30 000 h	40 000 h	50 000 h
LLMF	0.96	0.92	0.88	0.84	0.80
LSF	1	1	1	1	1

The Maintenance Factor (MF), as defined in EN 12464-1, is calculated as  $MF = LLMF \times LSF \times LMF \times RMF$ . LLMF (Lamp Lumen Maintenance Factor) and LSF (Lamp Survival Factor) depend on the luminaire type and quality, while LMF and RMF are influenced by environmental factors like dust, room conditions, and maintenance intervals.

## ACOUSTIC PERFORMANCE (ISO $A_{OBJ}$ , $M^2$ )



Frequency (Hz)	125	250	500	1000	2000	4000
per m <sup>2</sup>	0.05	0.15	0.40	0.70	0.80	0.75

The graphic shows the equivalent sound absorption per object ( $A_{obj}$ ) at the third-octave-band center frequency in accordance with ISO 20189. During the measurement, pink noise was used as the excitation signal in a hard-walled room.

Material Thickness: 12 mm

## LUMINAIRES PER CIRCUIT BREAKER TYPE

B16	B20	C16	C20
39	39	39	39

This table provides an overview of different types of circuit breakers and the maximum number of lamps that can be connected to each breaker type. The permissible number depends on the characteristics of the circuit breaker (e.g., Type B, C, or D) as well as the power consumption and inrush current of the lamps used. These values serve as a reference for planning electrical installations in lighting applications.

PROJECT \_\_\_\_\_

TYPE \_\_\_\_\_

SPECIFIER \_\_\_\_\_

QUANTITY \_\_\_\_\_

DATE \_\_\_\_\_

**FIXTURE Finish**

Sparkling Silver - 01 (SSR)

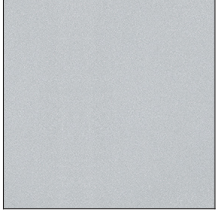

Black Velvet - 02 (BKV)



Crystal White - 03 (CWI)

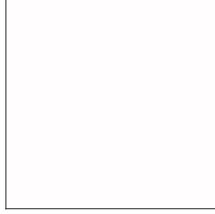

Creamy - 04 (CRY)

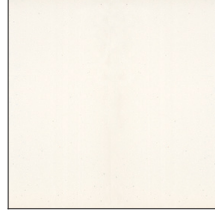

Hampton Bay - 05 (HAB)



Urban Forest - 07 (UFT)

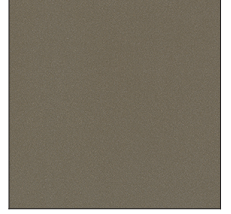

In the Army - 08 (ITA)

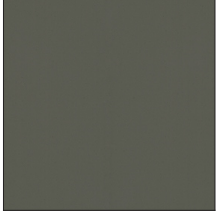

Rusty Angel - 09 (RUA)



Fade to Gray - 12 (FTG)



Mysterious Gray - 13 (MYG)

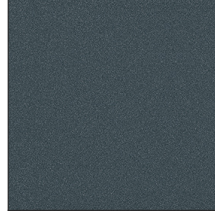

Lost Dream - 15 (LOD)

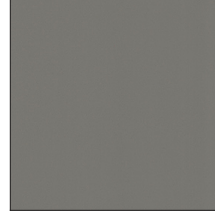

Purple Sky - 16 (PUS)

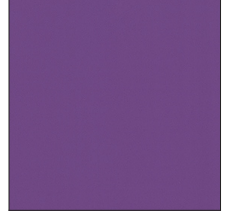

Fresh Oh - 17 (FRO)

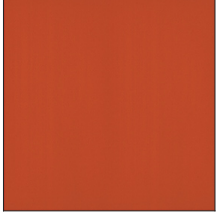

Funky P. - 18 (FUP)

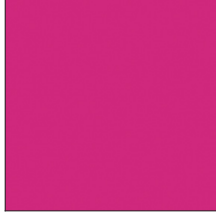

Kissing Aphrodite - 19 (KIA)

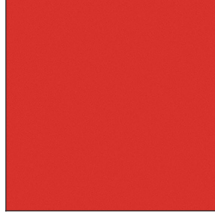

Poseidon's Paradise - 20 (POP)

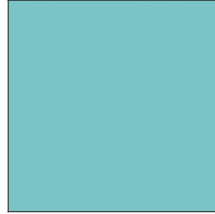

Blue Sky - 21 (BLS)



Spring Green - 22 (SPG)

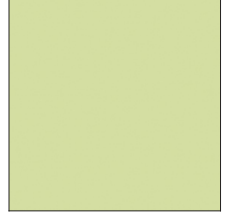

Mellow Yellow - 23 (MEY)

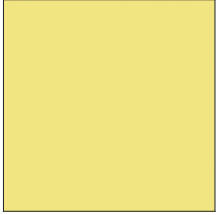

Golden Heart - 24 (GOH)

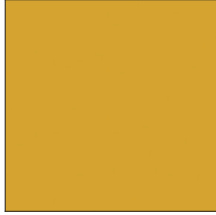

Champagne Cream - 26 (CHC)



Copper Mine - 27 (COM)

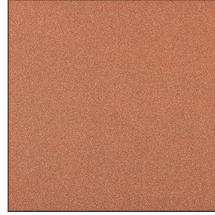

Ancient Bronze - 28 (ABZ)



Jazz Gold - 29 (JAG)



Olive Breeze - 30 (OBR)

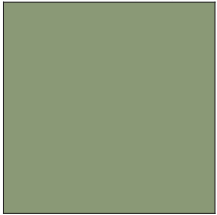

Moonlight Silver - 31 (MOS)

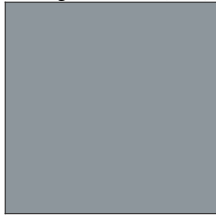

Rosewood Red - 32 (ROR)



**Digital:** Not all screens are calibrated the same, and therefore, colors will appear differently between screens.

**Physical:** When texture is involved, there will be variations in color, character, and tone within a product series and between product families.

**Champagne Cream, Copper Mine, Ancient Bronze + Jazz Gold:** These finishes have slight fading from specific powder coating production. Each luminaire will slightly vary.

PROJECT \_\_\_\_\_

TYPE \_\_\_\_\_

SPECIFIER \_\_\_\_\_

QUANTITY \_\_\_\_\_

DATE \_\_\_\_\_

#### HOLDER Finish

Sparkling Silver - 01 (SSR)

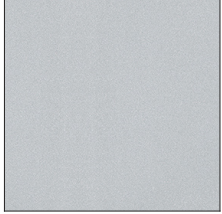

Black Velvet - 02 (BKV)



Crystal White - 03 (CWI)



Creamy - 04 (CRY)

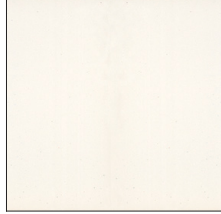

Hampton Bay - 05 (HAB)



Lagoon - 06 (LAG)



Urban Forest - 07 (UFT)



In the Army - 08 (ITA)

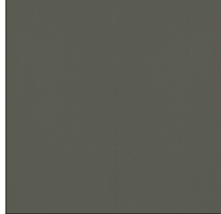

Rusty Angel - 09 (RUA)



Rusty Rush - 10 (RUR)



Milk and Chocolate - 11 (MIC)



Fade to Gray - 12 (FTG)



Mysterious Gray - 13 (MYG)



Twilight - 14 (TWT)



Lost Dream - 15 (LOD)

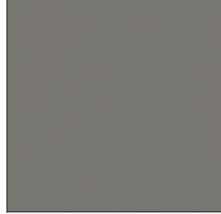

Purple Sky - 16 (PUS)

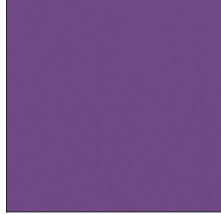

Fresh Oh - 17 (FRO)

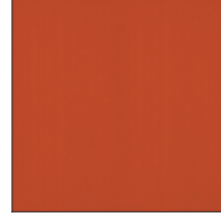

Funky P. - 18 (FUP)



Kissing Aphrodite - 19 (KIA)

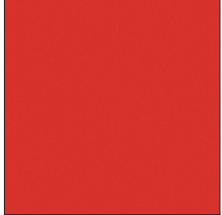

Poseidon's Paradise - 20 (POP)



Blue Sky - 21 (BLS)



Spring Green - 22 (SPG)



Mellow Yellow - 23 (MEY)

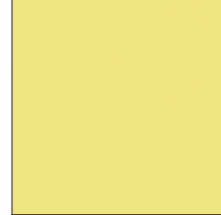

Golden Heart - 24 (GOH)



Gun Metal - 25 (GUM)



Champagne Cream - 26 (CHC)



Copper Mine - 27 (COM)



Ancient Bronze - 28 (ABZ)



Jazz Gold - 29 (JAG)



**Digital:** Not all screens are calibrated the same, and therefore, colors will appear differently between screens.

**Physical:** When texture is involved, there will be variations in color, character, and tone within a product series and between product families.

**Champagne Cream, Copper Mine, Ancient Bronze + Jazz Gold:** These finishes have slight fading from specific powder coating production. Each luminaire will slightly vary.

PROJECT \_\_\_\_\_

TYPE \_\_\_\_\_

SPECIFIER \_\_\_\_\_

QUANTITY \_\_\_\_\_

DATE \_\_\_\_\_

#### ACOUSTIC Finish

Snowfall White - 44 (SFW)

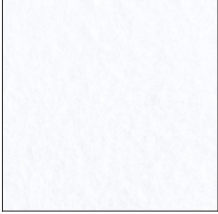

Creamy White - 97 (CW)



Stone Echo - 83 (SEE)

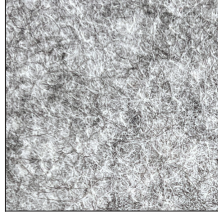

Smoky Iron - 50 (SYN)

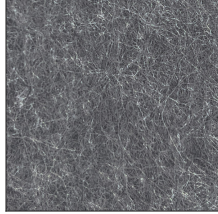

Midnight Stone - 51 (MTS)

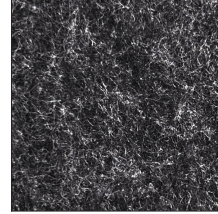

Phantom Black - 71 (PMB)



Twilight Navy - 69 (TTN)

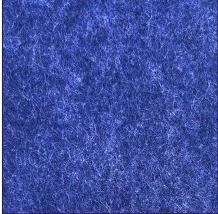

Cloudy Blue - 73 (CYB)



Soft Olive - 82 (STO)

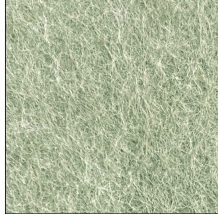

Deep Evergreen - 91 (DPE)

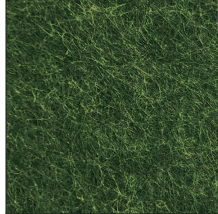

Bronze Shadow - 87 (BES)

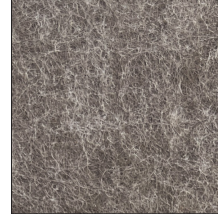

Savannah Brown - 42 (SHB)



Amber Earth - 55 (ARE)

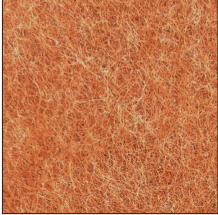

Autumn Ember - 90 (ANE)

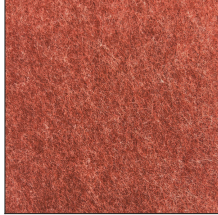

Vintage Red - 99 (VRD)

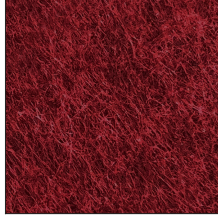

Coral Reef - 98 (CRF)



### LEGEND

floor-mounted	pivotal	special LED (upon request) RGB, RGBW, tunable, gold+, meat+, art+, fashion+
wall and ceiling: recessed and surface mounted	rotating	warm dim / natural dimming LED
ceiling-mounted and wall-mounted	illuminate tilted	rechargeable battery powered
wall-mounted	color of suspension cable	fixture with natural vivid LED (upon request)
omni-directional light distribution	length of suspension cable	color rendering index
direct light distribution	reflector degree selection	color temperature
direct/indirect light distribution	super spot	lumen (luminous flux)
indirect light distribution	lens	efficacy (lumens per watt)
asymmetric light distribution	lens pack	Unified Glare Rating (UGR) range from 5-40
aura light distribution	shine ring	marine grade (AISI 316 stainless steel)
round wall or ceiling cut-out	integrated shine ring with diffuser	walk on
square wall or ceiling cut-out	free individual colors 01-29	drive on
the supplied jig specifies the cutout dimensions	individual colors: 00 (free of charge), 01-25 (extra charge)	Dark Sky Compliance
minimum distance (meters) lamp - object	luminaire part to be colored (F1)	Americans with Disabilities Act (less than 4" off the wall located between 27"-84" from floor)
recessed depth	luminaire part to be colored (F2)	lamp protected against explosion
ceiling thickness in mm	luminaire part to be colored (F3)	blown glass using traditional methods by master glass blower
ceiling thickness selection	luminaire part to be colored (F4)	acoustic material
dimmable DP (phase), DV (0-10V), DD (dali), DS (step-dim)	luminaire part to be colored (F5)	protection class I, protection insulation
included or excluded LED driver/transformer/control gear	color of 3-circuit adaptor	protection class II, protection insulation
separately switchable	indirect diffuser	ETL Certified to UL and CSA Standards
sensor	direct diffuser	UL Certified to UL and CSA Standards
remote control	ball-proof (upon request)	CSA Certified to UL and CSA Standards
available upon request	accessory	Certified for North American Standards

### IP RATING

IP20	protected against ingress of solid bodies greater than 12.5mm (finger)
IP33	protected against ingress of solid bodies greater than 2.5mm protected against sprays of water up to 60 degrees from the vertical (rain)
IP40	protected against ingress of solid bodies greater than 1mm (wire) no protection against the ingress of moisture
IP43	protected against ingress of solid bodies greater than 1mm (wire) protected against sprays of water up to 60 degrees from the vertical (rain)
IP44	protected against ingress of solid bodies greater than 1mm (wire) protected against water splashed from all directions
IP54	protected against limited ingress of dust (wet rooms/covered outdoor areas) protected against water splashed from all directions
IP65	protected against ingress of dust protected against jets of water
IP66	protected against ingress of dust protected against powerful jets of water or heavy seas
IP67	protected against ingress of dust protected against immersion of water between 15cm - 1m for 30 minutes
IP68	protected against ingress of dust protected against immersion of water under pressure for long periods

### IK RATING

IK01	protected against 0.14 joules impact (equivalent to 0.25kg mass dropped from 56mm above the surface)
IK02	protected against 0.2 joules impact (equivalent to 0.25kg mass dropped from 80mm above the surface)
IK03	protected against 0.35 joules impact (equivalent to 0.25kg mass dropped from 140mm above the surface)
IK04	protected against 0.5 joules impact (equivalent to 0.25kg mass dropped from 200mm above the surface)
IK05	protected against 0.7 joules impact (equivalent to 0.25kg mass dropped from 280mm above the surface)
IK06	protected against 1 joules impact (equivalent to 0.25kg mass dropped from 400mm above the surface)
IK07	protected against 2 joules impact (equivalent to 0.5kg mass dropped from 400mm above the surface)
IK08	protected against 5 joules impact (equivalent to 1.7kg mass dropped from 300mm above the surface)
IK09	protected against 10 joules impact (equivalent to 5.0kg mass dropped from 200mm above the surface)
IK10	protected against 20 joules impact (equivalent to 5.0kg mass dropped from 400mm above the surface)