

PROJECT
TYPE
SPECIFIER
QUANTITY
DATE

SILEZZ SUSPENSION

A3001056-

base number	Color Temperature	Finishes (Diamond)	Finishes (Circle)	Finishes (Triangle)	Acoustic Options	Cable Length and Finish	Diffuser Options
-------------	-------------------	--------------------	-------------------	---------------------	------------------	-------------------------	------------------

- To build a product code in our configurator select the specify button on the base model # product page
- To build a manual product code on this datasheet choose from the options listed below in blue font and add the suffix to the base model #

GENERAL

Series: Silenzz
Partner: Prolicht
Division: Architectural
Installation: Suspension
Product Type: Acoustic
Mounting Location: Ceiling
Light Distribution: Direct / Indirect

PHYSICAL

Shape: Cone
Diameter (mm): 1120
Diameter (in): 44 1/8"
Height (mm): 685
Height (in): 26 15/16"
Weight (kg): 14.5
Diffuser: Clear / Microprism / Clear Microprism
Fixture Finish: SSR / BKV / CWI / CRY / HAB / UFT / ITA / RUA / FTG / MYG / LOD / PUS / FRO / FUP / KIA / POP / BLS / SPG / MEY / GOH / CHC / COM / ABZ / JAG / OBR / MOS / ROR
Holder Finish: SSR / BKV / CWI / CRY / HAB / LAG / UFT / ITA / RUA / RUR / MIC / FTG / MYG / TWT / LOD / PUS / FRO / FUP / KIA / POP / BLS / SPG / MEY / GOH / GUM / CHC / COM / ABZ / JAG
Acoustic Finish: SFW / CYW / SEE / SYN / MTS / PMB / TTN / CYB / STO / DPE / BES / SHB / ARE / ANE / VRD / CRF
Fixture Material: Acoustic
Primary Material: Acoustic
Cable Details: 2000mm/78 3/4" or 6000mm/236 1/4" Cable, - Black, Orange, Red, Transparent and White

ELECTRICAL

Lamp Type: LED
Input Wattage (W): 125
Total Output Wattage (W): 113.6
Dimming: Tri-Mode (Non-Dimming and Phase Dimming (120Vac only) and 0-10V Dimming)
Driver Included: Yes
Driver Location: Integrated
Driver Class: Class 2
Input Voltage (V): 120 - 277
Upon Request: MATTER Dimming / DALI Dimming (Remote)

LED

Color Temperature (°K): 2700 / 3000 / 3500 / 4000
Max. Delivered Lumen (lm): Max 17980
CRI: >90 CRI
Lamp Life (hrs): 50000

RATINGS AND CERTIFICATIONS

Certified By: Certified for North American Standards
IP rating: IP20

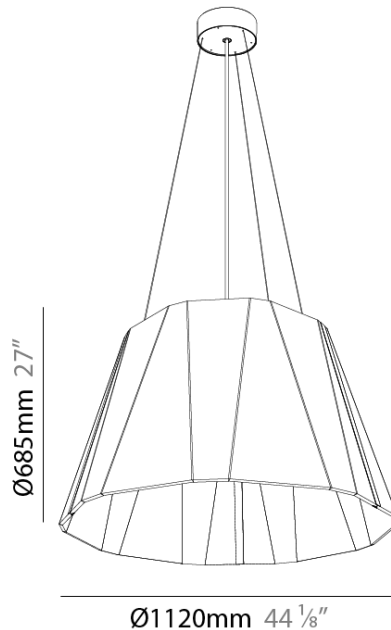

A3001056-

PROJECT	_____
TYPE	_____
SPECIFIER	_____
QUANTITY	_____
DATE	_____

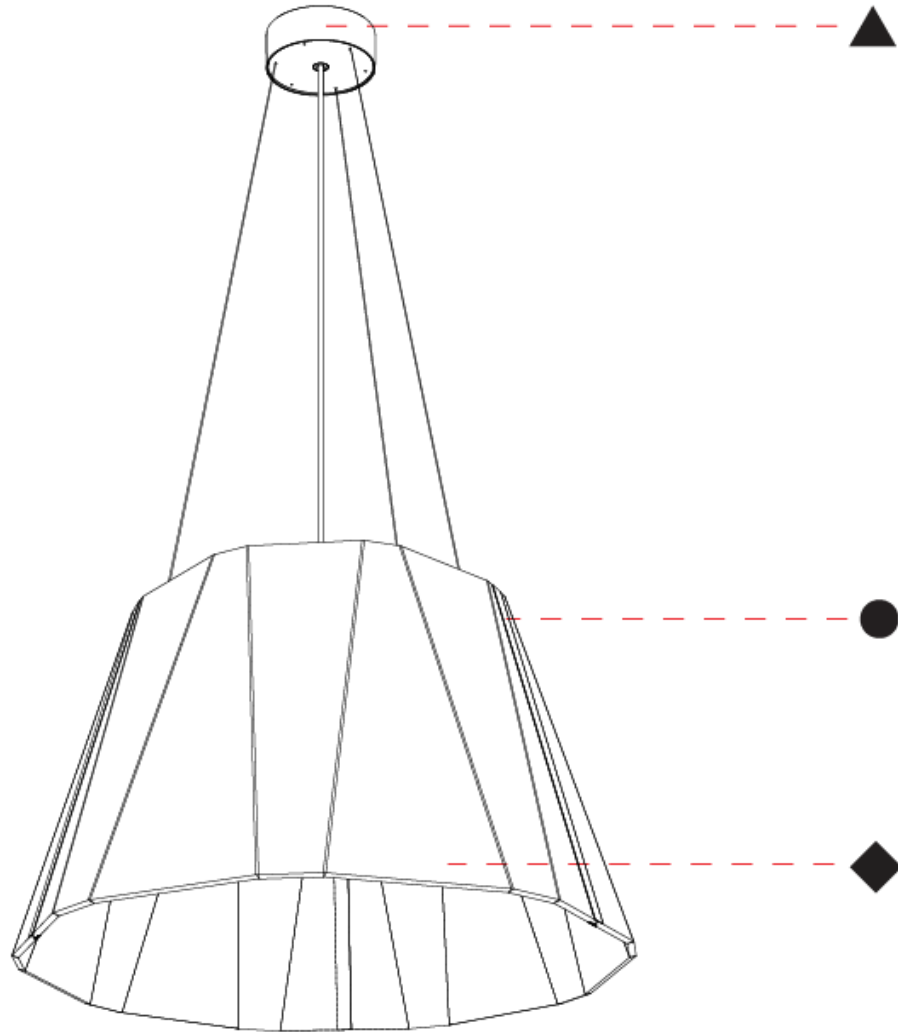

A

MAINTENANCE FACTOR

Service life	10 000 h	20 000 h	30 000 h	40 000 h	50 000 h
LLMF	0.96	0.92	0.88	0.84	0.80
LSF	1	1	1	1	1

The Maintenance Factor (MF), as defined in EN 12464-1, is calculated as $MF = LLMF \times LSF \times LMF \times RMF$. LLMF (Lamp Lumen Maintenance Factor) and LSF (Lamp Survival Factor) depend on the luminaire type and quality, while LMF and RMF are influenced by environmental factors like dust, room conditions, and maintenance intervals.

ACOUSTIC PERFORMANCE (ISO A_{OBJ} , M^2)



Frequency (Hz)	125	250	500	1000	2000	4000
per m ²	0.05	0.15	0.40	0.70	0.80	0.75

The graphic shows the equivalent sound absorption per object (A_{obj}) at the third-octave-band center frequency in accordance with ISO 20189. During the measurement, pink noise was used as the excitation signal in a hard-walled room.

Material Thickness: 12 mm

LUMINAIRES PER CIRCUIT BREAKER TYPE

B10	B13	B16	B20	C10	C13	C16	C20
6	8	10	12	10	13	16	21

This table provides an overview of different types of circuit breakers and the maximum number of lamps that can be connected to each breaker type. The permissible number depends on the characteristics of the circuit breaker (e.g., Type B, C, or D) as well as the power consumption and inrush current of the lamps used. These values serve as a reference for planning electrical installations in lighting applications.

ZANEEN®

SILEZZ SUSPENSION

COLOR FINISH CHART

PROJECT _____

TYPE _____

SPECIFIER _____

QUANTITY _____

DATE _____

FIXTURE Finish

Sparkling Silver - 01 (SSR)

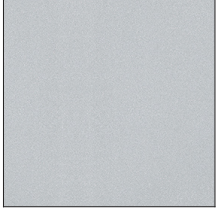

Black Velvet - 02 (BKV)



Crystal White - 03 (CWI)



Creamy - 04 (CRY)

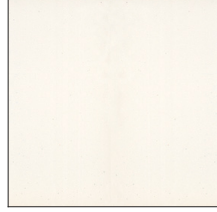

Hampton Bay - 05 (HAB)



Urban Forest - 07 (UFT)



In the Army - 08 (ITA)

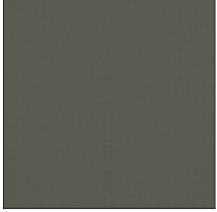

Rusty Angel - 09 (RUA)



Fade to Gray - 12 (FTG)



Mysterious Gray - 13 (MYG)

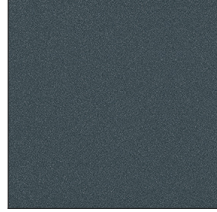

Lost Dream - 15 (LOD)



Purple Sky - 16 (PUS)

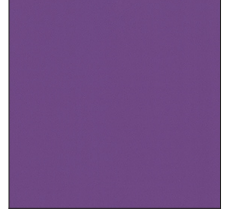

Fresh Oh - 17 (FRO)



Funky P. - 18 (FUP)



Kissing Aphrodite - 19 (KIA)



Poseidon's Paradise - 20 (POP)

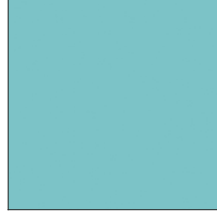

Blue Sky - 21 (BLS)



Spring Green - 22 (SPG)

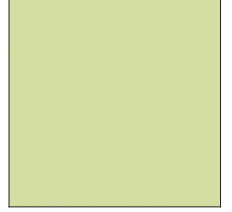

Mellow Yellow - 23 (MEY)

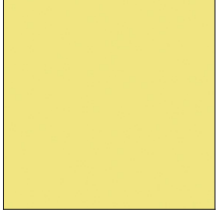

Golden Heart - 24 (GOH)

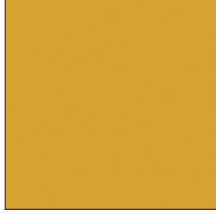

Champagne Cream - 26 (CHC)



Copper Mine - 27 (COM)



Ancient Bronze - 28 (ABZ)



Jazz Gold - 29 (JAG)



Olive Breeze - 30 (OBR)

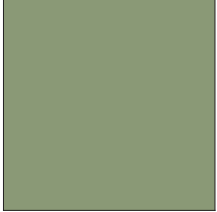

Moonlight Silver - 31 (MOS)

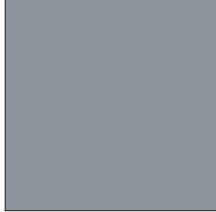

Rosewood Red - 32 (ROR)



Digital: Not all screens are calibrated the same, and therefore, colors will appear differently between screens.

Physical: When texture is involved, there will be variations in color, character, and tone within a product series and between product families.

Champagne Cream, Copper Mine, Ancient Bronze + Jazz Gold: These finishes have slight fading from specific powder coating production. Each luminaire will slightly vary.

PROJECT _____

TYPE _____

SPECIFIER _____

QUANTITY _____

DATE _____

HOLDER Finish

Sparkling Silver - 01 (SSR)

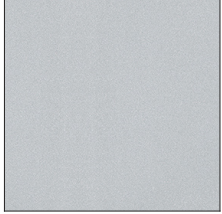

Black Velvet - 02 (BKV)



Crystal White - 03 (CWI)



Creamy - 04 (CRY)

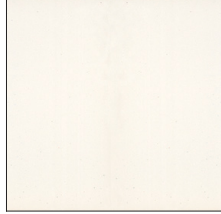

Hampton Bay - 05 (HAB)



Lagoon - 06 (LAG)



Urban Forest - 07 (UFT)



In the Army - 08 (ITA)

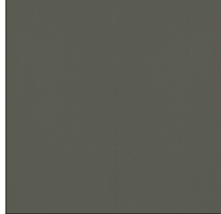

Rusty Angel - 09 (RUA)



Rusty Rush - 10 (RUR)



Milk and Chocolate - 11 (MIC)



Fade to Gray - 12 (FTG)



Mysterious Gray - 13 (MYG)



Twilight - 14 (TWT)



Lost Dream - 15 (LOD)

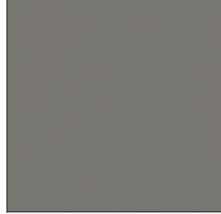

Purple Sky - 16 (PUS)

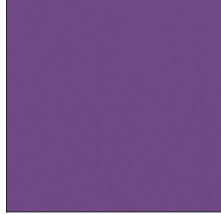

Fresh Oh - 17 (FRO)

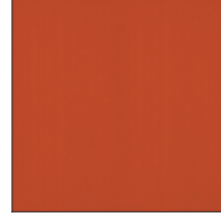

Funky P. - 18 (FUP)



Kissing Aphrodite - 19 (KIA)

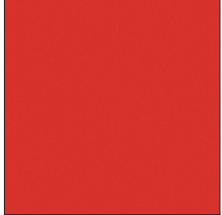

Poseidon's Paradise - 20 (POP)



Blue Sky - 21 (BLS)



Spring Green - 22 (SPG)



Mellow Yellow - 23 (MEY)

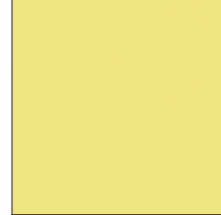

Golden Heart - 24 (GOH)



Gun Metal - 25 (GUM)



Champagne Cream - 26 (CHC)



Copper Mine - 27 (COM)



Ancient Bronze - 28 (ABZ)



Jazz Gold - 29 (JAG)



Digital: Not all screens are calibrated the same, and therefore, colors will appear differently between screens.

Physical: When texture is involved, there will be variations in color, character, and tone within a product series and between product families.

Champagne Cream, Copper Mine, Ancient Bronze + Jazz Gold: These finishes have slight fading from specific powder coating production. Each luminaire will slightly vary.

PROJECT _____

TYPE _____

SPECIFIER _____

QUANTITY _____

DATE _____

ACOUSTIC Finish

Snowfall White - 44 (SFW)



Creamy White - 97 (CWW)



Stone Echo - 83 (SEE)

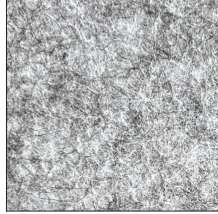

Smoky Iron - 50 (SYN)

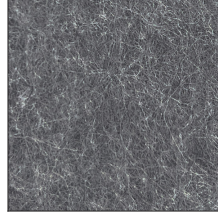

Midnight Stone - 51 (MTS)

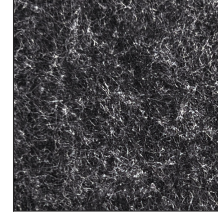

Phantom Black - 71 (PMB)



Twilight Navy - 69 (TTN)

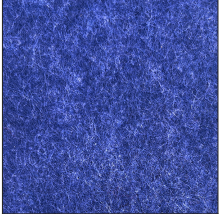

Cloudy Blue - 73 (CYB)



Soft Olive - 82 (STO)

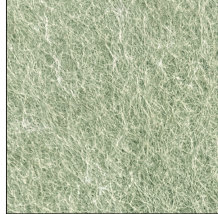

Deep Evergreen - 91 (DPE)

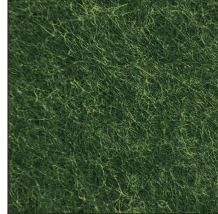

Bronze Shadow - 87 (BES)

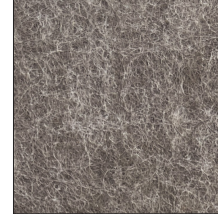

Savannah Brown - 42 (SHB)



Amber Earth - 55 (ARE)

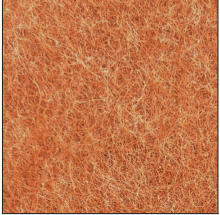

Autumn Ember - 90 (ANE)

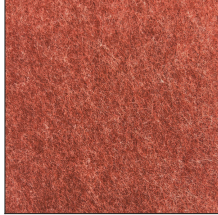

Vintage Red - 99 (VRD)

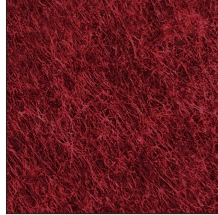

Coral Reef - 98 (CRF)

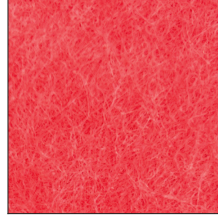

LEGEND

	floor-mounted		pivotal		special LED (upon request) RGB, RGBW, tunable, gold+, meat+, art+, fashion+
	wall and ceiling: recessed and surface mounted		rotating		warm dim / natural dimming LED
	ceiling-mounted and wall-mounted		illuminate tilted		rechargeable battery powered
	wall-mounted		color of suspension cable		fixture with natural vivid LED (upon request)
	omni-directional light distribution		length of suspension cable		color rendering index
	direct light distribution		reflector degree selection		color temperature
	direct/indirect light distribution		super spot		lumen (luminous flux)
	indirect light distribution		lens		efficacy (lumens per watt)
	asymmetric light distribution		lens pack		Unified Glare Rating (UGR) range from 5-40
	aura light distribution		shine ring		marine grade (AISI 316 stainless steel)
	round wall or ceiling cut-out		integrated shine ring with diffuser		walk on
	square wall or ceiling cut-out		free individual colors 01-29		drive on
	the supplied jig specifies the cutout dimensions		individual colors: 00 (free of charge), 01-25 (extra charge)		Dark Sky Compliance
	minimum distance (meters) lamp - object		luminaire part to be colored (F1)		Americans with Disabilities Act (less than 4" off the wall located between 27"-84" from floor)
	recessed depth		luminaire part to be colored (F2)		lamp protected against explosion
	ceiling thickness in mm		luminaire part to be colored (F3)		blown glass using traditional methods by master glass blower
	ceiling thickness selection		luminaire part to be colored (F4)		acoustic material
	dimnable DP (phase), DV (0-10V), DD (dali), DS (step-dim)		luminaire part to be colored (F5)		protection class I, protection insulation
	included or excluded LED driver/transformer/control gear		color of 3-circuit adaptor		protection class II, protection insulation
	separately switchable		indirect diffuser		ETL Certified to UL and CSA Standards
	sensor		direct diffuser		UL Certified to UL and CSA Standards
	remote control		ball-proof (upon request)		CSA Certified to UL and CSA Standards
	available upon request		accessory		Certified for North American Standards

IP RATING

	protected against ingress of solid bodies greater than 12.5mm (finger)
	protected against ingress of solid bodies greater than 2.5mm protected against sprays of water up to 60 degrees from the vertical (rain)
	protected against ingress of solid bodies greater than 1mm (wire) no protection against the ingress of moisture
	protected against ingress of solid bodies greater than 1mm (wire) protected against sprays of water up to 60 degrees from the vertical (rain)
	protected against ingress of solid bodies greater than 1mm (wire) protected against water splashed from all directions
	protected against limited ingress of dust (wet rooms/covered outdoor areas) protected against water splashed from all directions
	protected against ingress of dust protected against jets of water
	protected against ingress of dust protected against powerful jets of water or heavy seas
	protected against ingress of dust protected against immersion of water between 15cm - 1m for 30 minutes
	protected against ingress of dust protected against immersion of water under pressure for long periods

IK RATING

	protected against 0.14 joules impact (equivalent to 0.25kg mass dropped from 56mm above the surface)
	protected against 0.2 joules impact (equivalent to 0.25kg mass dropped from 80mm above the surface)
	protected against 0.35 joules impact (equivalent to 0.25kg mass dropped from 140mm above the surface)
	protected against 0.5 joules impact (equivalent to 0.25kg mass dropped from 200mm above the surface)
	protected against 0.7 joules impact (equivalent to 0.25kg mass dropped from 280mm above the surface)
	protected against 1 joules impact (equivalent to 0.25kg mass dropped from 400mm above the surface)
	protected against 2 joules impact (equivalent to 0.5kg mass dropped from 400mm above the surface)
	protected against 5 joules impact (equivalent to 1.7kg mass dropped from 300mm above the surface)
	protected against 10 joules impact (equivalent to 5.0kg mass dropped from 200mm above the surface)
	protected against 20 joules impact (equivalent to 5.0kg mass dropped from 400mm above the surface)