

SIGN EVO SUSPENSION

A3001102-HE-

base number Color Finishes Finishes Diffuser Cable
 Temperature (Diamond) (Triangle) Options Length

- To build a product code in our configurator select the specify button on the base model # product page
- To build a manual product code on this datasheet choose from the options listed below in blue font and add the suffix to the base model #

GENERAL

Series: Sign EVO
 Partner: Prolicht
 Division: Architectural
 Installation: Suspension
 Product Type: Pendant
 Mounting Location: Ceiling
 Light Distribution: Direct / Indirect

PHYSICAL

Shape: Round
 Diameter (mm): 395
 Diameter (in): 15 1/2
 Height (mm): 82
 Height (in): 3 1/4
 Weight (kg): 4.2
 Diffuser: PMMA - Opal / Microprism / Clear Microprism
 Fixture Finish: SSR / BKV / CWI / CRY / HAB / UFT / ITA / RUA / FTG / MYG / LOD / PUS / FRO / FUP / KIA / POP / BLS / SPG / MEY / GOH / CHC / COM / ABZ / JAG / OBR / MOS / ROR
 Fixture Material: PMMA / Extruded Aluminum / Steel
 Cable Details: 2000mm or 6000mm Transparent Cable

ELECTRICAL

Lamp Type: LED (Zhaga Standard)
 Input Wattage (W): 14.6
 Total Output Wattage (W): 13.7
 Dimming: Non-Dimmable
 Driver Included: Yes
 Driver Location: Integrated
 Driver Type: Constant Current - Universal
 Driver Class: Class 2
 Input Voltage (V): 120
 Upon Request: 0-10V Dimming / Phase Dimming / DALI Dimming

LED

Color Temperature (°K): 2700 / 3000 / 3500 / 4000
 Max. Delivered Lumen (lm): Max 2280 (1616 Dir / 664 Ind)
 Nominal Lumen (lm): Max 2632
 CRI: >90 CRI
 Lamp Life (hrs): 50000

RATINGS AND CERTIFICATIONS

Certified By: Certified for North American Standards
 IP rating: IP40
 Glare Rating: ≤ 19

| | |
|-----------|-------|
| PROJECT | _____ |
| TYPE | _____ |
| SPECIFIER | _____ |
| QUANTITY | _____ |
| DATE | _____ |

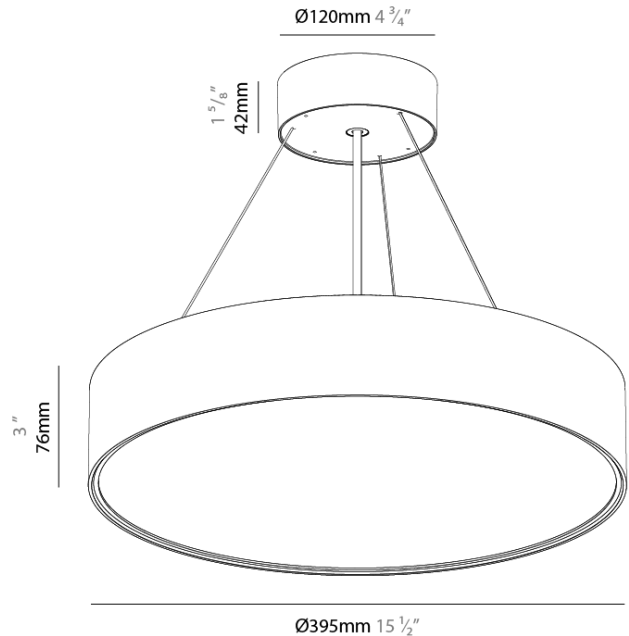

A3001102-HE-

| | |
|-----------|-------|
| PROJECT | _____ |
| TYPE | _____ |
| SPECIFIER | _____ |
| QUANTITY | _____ |
| DATE | _____ |

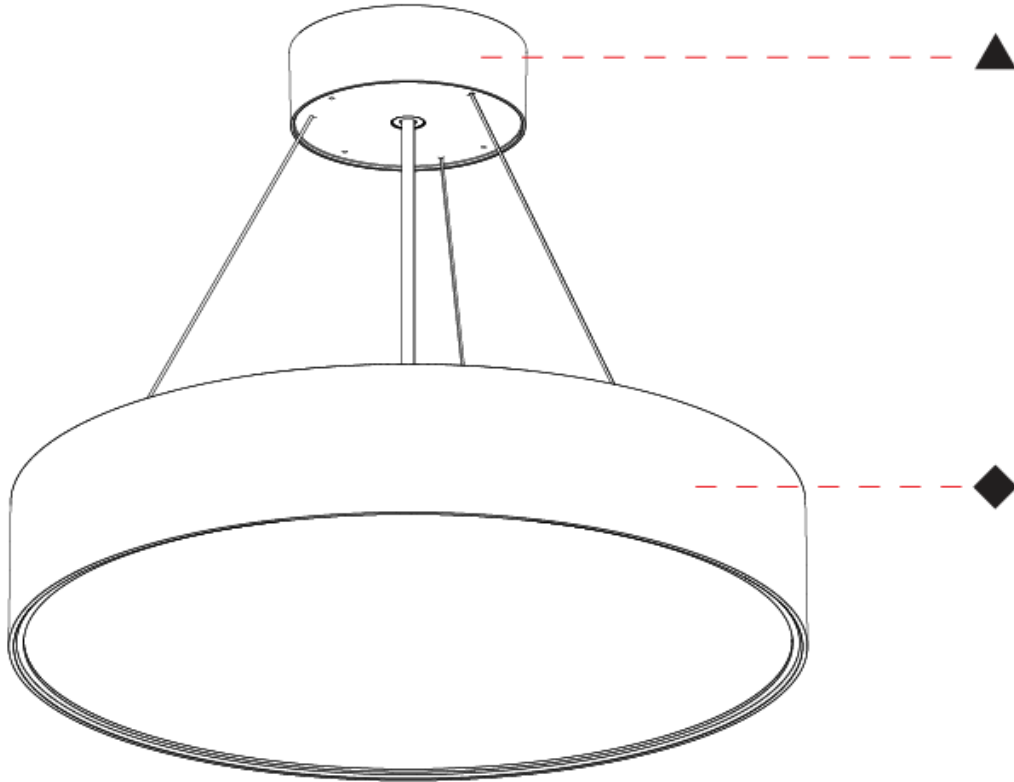

A

ZANEEN®

SIGN EVO SUSPENSION

COLOR FINISH CHART

PROJECT _____

TYPE _____

SPECIFIER _____

QUANTITY _____

DATE _____

FIXTURE Finish

Sparkling Silver - 01 (SSR)



Black Velvet - 02 (BKV)



Crystal White - 03 (CWI)



Creamy - 04 (CRY)



Hampton Bay - 05 (HAB)



Urban Forest - 07 (UFT)



In the Army - 08 (ITA)



Rusty Angel - 09 (RUA)



Fade to Gray - 12 (FTG)



Mysterious Gray - 13 (MYG)



Lost Dream - 15 (LOD)



Purple Sky - 16 (PUS)



Fresh Oh - 17 (FRO)



Funky P. - 18 (FUP)



Kissing Aphrodite - 19 (KIA)



Poseidon's Paradise - 20 (POP)



Blue Sky - 21 (BLS)



Spring Green - 22 (SPG)



Mellow Yellow - 23 (MEY)



Golden Heart - 24 (GOH)



Champagne Cream - 26 (CHC)



Copper Mine - 27 (COM)



Ancient Bronze - 28 (ABZ)



Jazz Gold - 29 (JAG)



Olive Breeze - 30 (OBR)



Moonlight Silver - 31 (MOS)



Rosewood Red - 32 (ROR)







































































Digital: Not all screens are calibrated the same, and therefore, colors will appear differently between screens.

Physical: When texture is involved, there will be variations in color, character, and tone within a product series and between product families.

Champagne Cream, Copper Mine, Ancient Bronze + Jazz Gold: These finishes have slight fading from specific powder coating production. Each luminaire will slightly vary.











LEGEND

| | | |
|--|--|--|
|  floor-mounted |  pivotable |  special LED (upon request) RGB, RGBW, tunable, gold+, meat+, art+, fashion+ |
|  wall and ceiling: recessed and surface mounted |  rotating |  warm dim / natural dimming LED |
|  ceiling-mounted and wall-mounted |  illuminate tilted |  rechargeable battery powered |
|  wall-mounted |  color of suspension cable |  fixture with natural vivid LED (upon request) |
|  omni-directional light distribution |  length of suspension cable |  color rendering index |
|  direct light distribution |  reflector degree selection |  color temperature |
|  direct/indirect light distribution |  super spot |  lumen (luminous flux) |
|  indirect light distribution |  lens |  efficacy (lumens per watt) |
|  asymmetric light distribution |  lens pack |  Unified Glare Rating (UGR) range from 5-40 |
|  aura light distribution |  shine ring |  marine grade (AISI 316 stainless steel) |
|  round wall or ceiling cut-out |  integrated shine ring with diffuser |  walk on |
|  square wall or ceiling cut-out |  free individual colors 01-29 |  drive on |
|  the supplied jig specifies the cutout dimensions |  individual colors: 00 (free of charge), 01-25 (extra charge) |  Dark Sky Compliance |
|  minimum distance (meters) lamp - object |  luminaire part to be colored (F1) |  Americans with Disabilities Act (less than 4" off the wall located between 27"-84" from floor) |
|  recessed depth |  luminaire part to be colored (F2) |  lamp protected against explosion |
|  ceiling thickness in mm |  luminaire part to be colored (F3) |  blown glass using traditional methods by master glass blower |
|  ceiling thickness selection |  luminaire part to be colored (F4) |  acoustic material |
|  dimmable DP (phase), DV (0-10V), DD (dali), DS (step-dim) |  luminaire part to be colored (F5) |  protection class I, protection insulation |
|  included or excluded LED driver/transformer/control gear |  color of 3-circuit adaptor |  protection class II, protection insulation |
|  separately switchable |  indirect diffuser |  ETL Certified to UL and CSA Standards |
|  sensor |  direct diffuser |  UL Certified to UL and CSA Standards |
|  remote control |  ball-proof (upon request) |  CSA Certified to UL and CSA Standards |
|  available upon request |  accessory |  Certified for North American Standards |

IP RATING

| | |
|--|--|
|  IP20 | protected against ingress of solid bodies greater than 12.5mm (finger) |
|  IP33 | protected against ingress of solid bodies greater than 2.5mm protected against sprays of water up to 60 degrees from the vertical (rain) |
|  IP40 | protected against ingress of solid bodies greater than 1mm (wire) no protection against the ingress of moisture |
|  IP43 | protected against ingress of solid bodies greater than 1mm (wire) protected against sprays of water up to 60 degrees from the vertical (rain) |
|  IP44 | protected against ingress of solid bodies greater than 1mm (wire) protected against water splashed from all directions |
|  IP54 | protected against limited ingress of dust (wet rooms/covered outdoor areas) protected against water splashed from all directions |
|  IP65 | protected against ingress of dust protected against jets of water |
|  IP66 | protected against ingress of dust protected against powerful jets of water or heavy seas |
|  IP67 | protected against ingress of dust protected against immersion of water between 15cm - 1m for 30 minutes |
|  IP68 | protected against ingress of dust protected against immersion of water under pressure for long periods |

IK RATING

| | |
|--|---|
|  IK01 | protected against 0.14 joules impact (equivalent to 0.25kg mass dropped from 56mm above the surface) |
|  IK02 | protected against 0.2 joules impact (equivalent to 0.25kg mass dropped from 80mm above the surface) |
|  IK03 | protected against 0.35 joules impact (equivalent to 0.25kg mass dropped from 140mm above the surface) |
|  IK04 | protected against 0.5 joules impact (equivalent to 0.25kg mass dropped from 200mm above the surface) |
|  IK05 | protected against 0.7 joules impact (equivalent to 0.25kg mass dropped from 280mm above the surface) |
|  IK06 | protected against 1 joules impact (equivalent to 0.25kg mass dropped from 400mm above the surface) |
|  IK07 | protected against 2 joules impact (equivalent to 0.5kg mass dropped from 400mm above the surface) |
|  IK08 | protected against 5 joules impact (equivalent to 1.7kg mass dropped from 300mm above the surface) |
|  IK09 | protected against 10 joules impact (equivalent to 5.0kg mass dropped from 200mm above the surface) |
|  IK10 | protected against 20 joules impact (equivalent to 5.0kg mass dropped from 400mm above the surface) |