

## POP 5 LIGHT SURFACE

### D42025-

base number            Finish             
Options           

- To build a product code in our configurator select the specify button on the base model # product page
- To build a manual product code on this datasheet choose from the options listed below in blue font and add the suffix to the base model #

#### GENERAL

Series: Pop             
Subseries: Pop 5 Light             
Brand: Icone             
Division: Design             
Mounting Type: Surface             
Mounting Location: Ceiling             
Subcategory: Ambient           

#### PHYSICAL

Shape: Rectangle             
Length (mm): 250             
Length (in): 9 <sup>13</sup>/<sub>16</sub>             
Width (mm): 450             
Width (in): 17 <sup>11</sup>/<sub>16</sub>             
Extension (mm): 30             
Extension (in): 1 <sup>3</sup>/<sub>16</sub>             
Light Distribution: Direct             
Fixture Finish: WHI / WAM / BKA / GBG / SLA             
Fixture Material: Aluminum           

#### ELECTRICAL

Lamp Type: LED             
Total Output Wattage (W): 22.5             
Dimming: Electronic Low Voltage Dimming             
Input Voltage (V): 120Vac Direct Line           

#### LED

Number of LEDs: 5             
Color Temperature (°K): 3000             
Nominal Lumen (lm): 1750             
CRI: >90 CRI             
Lamp Life (hrs): 50000           

#### RATINGS AND CERTIFICATIONS

Certified By: Certified for North American Standards             
IP rating: IP20           

|           |       |
|-----------|-------|
| PROJECT   | _____ |
| TYPE      | _____ |
| SPECIFIER | _____ |
| QUANTITY  | _____ |
| DATE      | _____ |

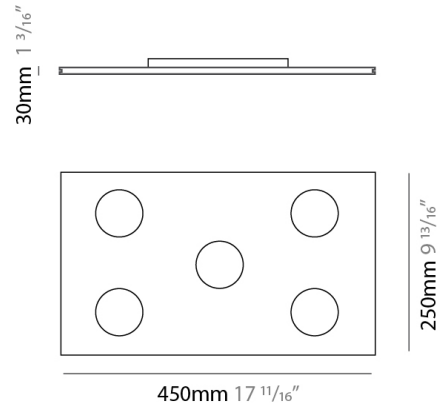
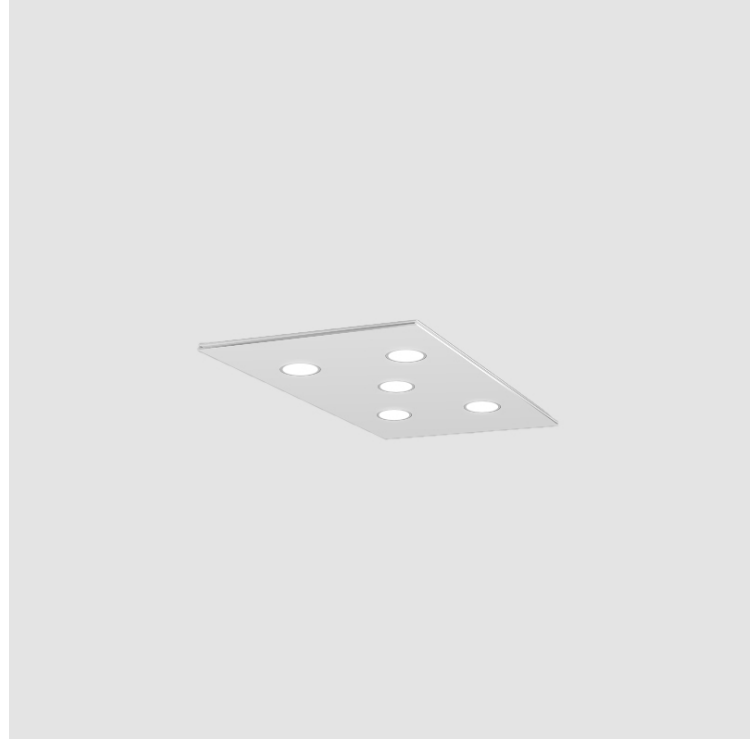

## POP 5 LIGHT SURFACE

D42025-

|           |       |
|-----------|-------|
| PROJECT   | _____ |
| TYPE      | _____ |
| SPECIFIER | _____ |
| QUANTITY  | _____ |
| DATE      | _____ |

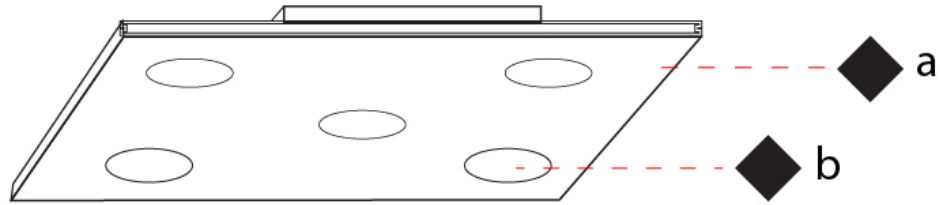

## POP 5 LIGHT SURFACE COLOR FINISH CHART

PROJECT \_\_\_\_\_

TYPE \_\_\_\_\_

SPECIFIER \_\_\_\_\_

QUANTITY \_\_\_\_\_

DATE \_\_\_\_\_

### Fixture Finish

White - WHI

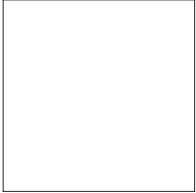

White/Aluminium - WAM

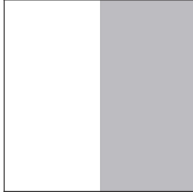

Black/Aluminium - BKA

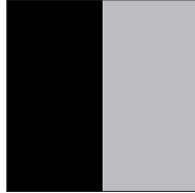

Gold Leaf/Brushed Gold - GBG

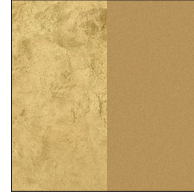

Silver Leaf/Aluminium - SLA

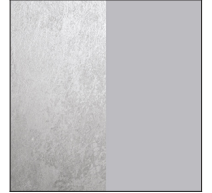

**Digital:** Not all screens are calibrated the same, and therefore, colors will appear differently between screens.

**Physical:** When texture is involved, there will be variations in color, character and tone within a product series and between product families.



|           |  |
|-----------|--|
| PROJECT   |  |
| TYPE      |  |
| SPECIFIER |  |
| QUANTITY  |  |
| DATE      |  |

### LEGEND

|  |   |  |  |  |  |
|--|---|--|--|--|--|
|  | floor-mounted   |  | pivotable  |  | special LED (upon request) RGB, RGBW, tunable, gold+, meat+, art+, fashion+                    |
|  | wall and ceiling: recessed and surface mounted            |  | rotating   |  | warm dim / natural dimming LED   |
|  | ceiling-mounted and wall-mounted                          |  | illuminate tilted  |  | rechargeable battery powered   |
|  | wall-mounted  |  | color of suspension cable                                    |  | fixture with natural vivid LED (upon request)  |
|  | omni-directional light distribution                       |  | length of suspension cable                                   |  | color rendering index  |
|  | direct light distribution                                 |  | reflector degree selection                                   |  | color temperature  |
|  | direct/indirect light distribution                        |  | super spot   |  | lumen (luminous flux)  |
|  | indirect light distribution                               |  | lens   |  | efficacy (lumens per watt)   |
|  | asymmetric light distribution                             |  | lens pack  |  | Unified Glare Rating (UGR) range from 5-40   |
|  | aura light distribution                                   |  | shine ring   |  | marine grade (AISI 316 stainless steel)  |
|  | round wall or ceiling cut-out                             |  | integrated shine ring with diffuser                          |  | walk on  |
|  | square wall or ceiling cut-out                            |  | free individual colors 01-29                                 |  | drive on   |
|  | the supplied jig specifies the cutout dimensions          |  | individual colors: 00 (free of charge), 01-25 (extra charge) |  | Dark Sky Compliance  |
|  | minimum distance (meters) lamp - object                   |  | luminaire part to be colored (F1)                            |  | Americans with Disabilities Act (less than 4" off the wall located between 27"-84" from floor) |
|  | recessed depth  |  | luminaire part to be colored (F2)                            |  | lamp protected against explosion   |
|  | ceiling thickness in mm                                   |  | luminaire part to be colored (F3)                            |  | blown glass using traditional methods by master glass blower                                   |
|  | ceiling thickness selection                               |  | luminaire part to be colored (F4)                            |  | acoustic material  |
|  | dimmable DP (phase), DV (0-10V), DD (dali), DS (step-dim) |  | luminaire part to be colored (F5)                            |  | protection class I, protection insulation  |
|  | included or excluded LED driver/transformer/control gear  |  | color of 3-circuit adaptor                                   |  | protection class II, protection insulation   |
|  | separately switchable                                     |  | indirect diffuser  |  | ETL Certified to UL and CSA Standards  |
|  | sensor  |  | direct diffuser  |  | UL Certified to UL and CSA Standards   |
|  | remote control  |  | ball-proof (upon request)                                    |  | CSA Certified to UL and CSA Standards  |
|  | available upon request                                    |  | accessory  |  | Certified for North American Standards   |

### IP RATING

|  |  |
|--|--|
|  | protected against ingress of solid bodies greater than 12.5mm (finger)   |
|  | protected against ingress of solid bodies greater than 2.5mm<br>protected against sprays of water up to 60 degrees from the vertical (rain)      |
|  | protected against ingress of solid bodies greater than 1mm (wire)<br>no protection against the ingress of moisture                               |
|  | protected against ingress of solid bodies greater than 1mm (wire)<br>protected against sprays of water up to 60 degrees from the vertical (rain) |
|  | protected against ingress of solid bodies greater than 1mm (wire)<br>protected against water splashed from all directions                        |
|  | protected against limited ingress of dust (wet rooms/covered outdoor areas)<br>protected against water splashed from all directions              |
|  | protected against ingress of dust<br>protected against jets of water   |
|  | protected against ingress of dust<br>protected against powerful jets of water or heavy seas  |
|  | protected against ingress of dust<br>protected against immersion of water between 15cm - 1m for 30 minutes                                       |
|  | protected against ingress of dust<br>protected against immersion of water under pressure for long periods  |

### IK RATING

|  |   |
|--|---|
|  | protected against 0.14 joules impact (equivalent to 0.25kg mass dropped from 56mm above the surface)  |
|  | protected against 0.2 joules impact (equivalent to 0.25kg mass dropped from 80mm above the surface)   |
|  | protected against 0.35 joules impact (equivalent to 0.25kg mass dropped from 140mm above the surface) |
|  | protected against 0.5 joules impact (equivalent to 0.25kg mass dropped from 200mm above the surface)  |
|  | protected against 0.7 joules impact (equivalent to 0.25kg mass dropped from 280mm above the surface)  |
|  | protected against 1 joules impact (equivalent to 0.25kg mass dropped from 400mm above the surface)    |
|  | protected against 2 joules impact (equivalent to 0.5kg mass dropped from 400mm above the surface)     |
|  | protected against 5 joules impact (equivalent to 1.7kg mass dropped from 300mm above the surface)     |
|  | protected against 10 joules impact (equivalent to 5.0kg mass dropped from 200mm above the surface)    |
|  | protected against 20 joules impact (equivalent to 5.0kg mass dropped from 400mm above the surface)    |