

PROJECT _____
 TYPE _____
 SPECIFIER _____
 QUANTITY _____
 DATE _____

APPLY 1 SURFACE

E10W0074-

base number _____ Color _____
 Temperature _____

- To build a product code in our configurator select the specify button on the base model # product page
- To build a manual product code on this datasheet choose from the options listed below in blue font and add the suffix to the base model #

GENERAL

Series: Apply _____
 Subseries: Apply 1 _____
 Brand: Side _____
 Division: Exterior _____
 Mounting Type: Surface _____
 Mounting Location: Wall _____
 Subcategory: Wall Effect _____

PHYSICAL

Shape: Abstract _____
 Length (mm): 275 _____
 Length (in): 10 ¹³/₁₆ _____
 Height (mm): 140 _____
 Height (in): 5 ¹/₂ _____
 Extension (mm): 85 _____
 Extension (in): 3 ³/₈ _____
 Light Distribution: Direct _____
 Weight (kg): 1.3 _____
 Weight (lbs): 2.87 _____
 Diffuser: Frosted tempered glass _____
 Gasket: Silicone rubber _____
 Fixture Finish: BLK _____
 Fixture Material: Aluminum Die Cast _____

ELECTRICAL

Lamp Type: LED (Zhaga Standard) _____
 Input Wattage (W): 9 _____
 Total Output Wattage (W): 8 _____
 Dimming: Non-Dimmable _____
 Driver Included: Yes _____
 Driver Location: Integrated _____
 Driver Type: Constant Voltage - Universal _____
 Driver Class: Class 2 _____
 Input Voltage (V): 120 - 277 _____
 Output Voltage (V): 24 _____
 Upon Request: Remote: 0-10Vdc dimming / Phase dimming 120Vac only _____

LED

Color Temperature (°K): 3000 / 4000 / 6000 _____
 Max. Delivered Lumen (lm): 518 / 594.5 / 620 _____
 Nominal Lumen (lm): 860 / 900 / 960 _____
 CRI: >85 CRI _____
 Lamp Life (hrs): 50000 _____

OPTICAL

Optic°: Symmetric _____

RATINGS AND CERTIFICATIONS

Certified By: Certified for North American Standards _____
 IP rating: IP65 _____
 Bug Rating: B0 U0 G0 _____
 Upon Request: Dark Sky Certification _____



275mm 10 ¹³/₁₆"

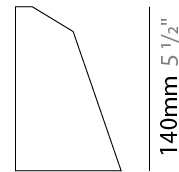

85mm 3 ³/₈"

140mm 5 ¹/₂"



APPLY 1 SURFACE

E10W0074-

PROJECT	_____
TYPE	_____
SPECIFIER	_____
QUANTITY	_____
DATE	_____



APPLY MINI SURFACE

E10W0076- _____ - _____

base number Color Finish
 Temperature Options

- To build a product code in our configurator select the specify button on the base model # product page
- To build a manual product code on this datasheet choose from the options listed below in blue font and add the suffix to the base model #

GENERAL

Series: Apply
 Subseries: Apply Mini
 Brand: Side
 Division: Exterior
 Mounting Type: Surface
 Mounting Location: Wall
 Subcategory: Wall Effect

PHYSICAL

Shape: Abstract
 Length (mm): 120
 Length (in): 4 ¾
 Height (mm): 120
 Height (in): 4 ¾
 Extension (mm): 105
 Extension (in): 4 ⅞
 Light Distribution: Direct
 Weight (kg): 0.75
 Weight (lbs): 1.65
 Diffuser: Frosted tempered glass
 Gasket: Silicon rubber
 Fixture Finish: [BLK](#) / [BRN](#) / [GRY](#)
 Fixture Material: Aluminum Die Cast

ELECTRICAL

Lamp Type: LED (Zhaga Standard)
 Input Wattage (W): 8.2
 Total Output Wattage (W): 7.2
 Dimming: Non-Dimmable
 Driver Included: Yes
 Driver Location: Integrated
 Driver Type: Constant Current - 120Vac
 Driver Class: Class 2
 Input Voltage (V): 120 - 277
 Constant Current (MA): 350
 Upon Request: (Not included - see components [IP65 or higher enclosure to be supplied by others]) Remote: 0-10Vdc dimming / Phase dimming 120Vac only / Non-dimming 120/277Vac

LED

Color Temperature (°K): [3000](#) / [4000](#)
 Max. Delivered Lumen (lm): 576.1 / 578
 Nominal Lumen (lm): 648 / 648
 CRI: >80 CRI
 Lamp Life (hrs): 50000

OPTICAL

Beam Angle: Asymmetrical

RATINGS AND CERTIFICATIONS

Certified By: Certified for North American Standards
 IP rating: IP65
 Bug Rating: B1 U1 G0
 Upon Request: Dark Sky Certification

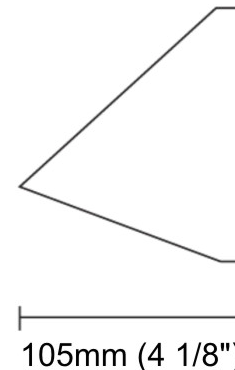
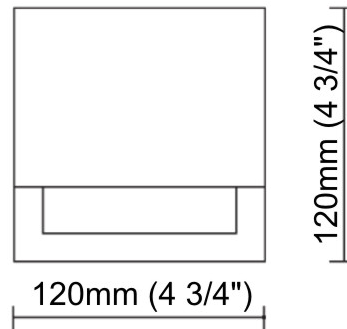

📦 0.75kg / 1.65lbs



APPLY MINI SURFACE

E10W0076-

PROJECT	_____
TYPE	_____
SPECIFIER	_____
QUANTITY	_____
DATE	_____

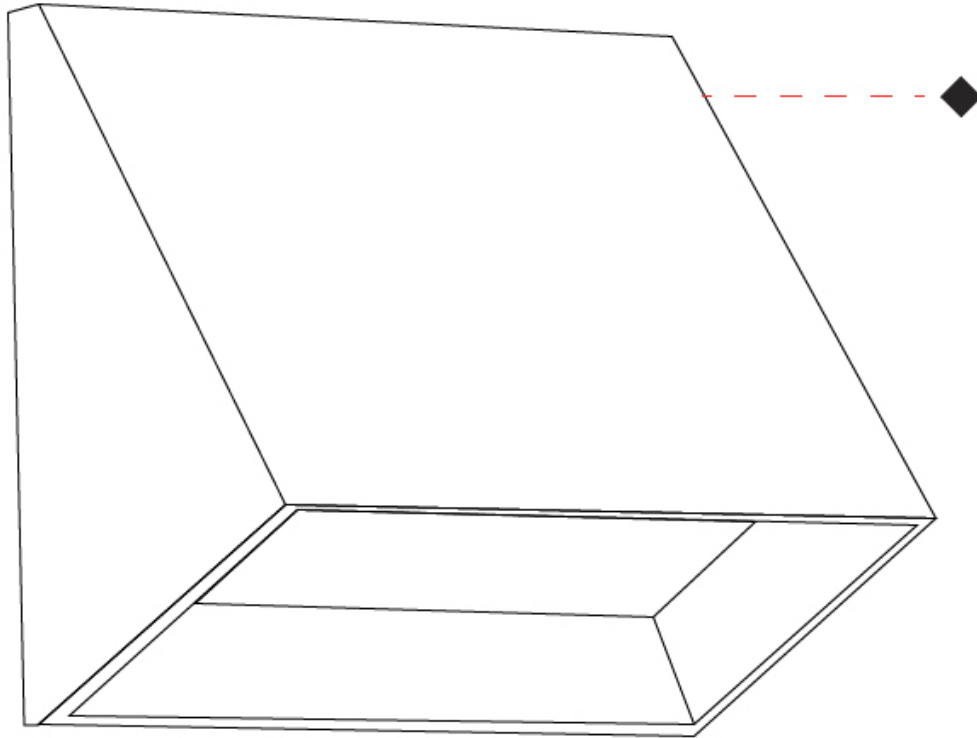

PROJECT
TYPE
SPECIFIER
QUANTITY
DATE

APPLY 2 SURFACE

E10W0134-

base number Color
Temperature

- To build a product code in our configurator select the specify button on the base model # product page
- To build a manual product code on this datasheet choose from the options listed below in blue font and add the suffix to the base model #

GENERAL

Series: Apply
 Subseries: Apply 2
 Brand: Side
 Division: Exterior
 Mounting Type: Surface
 Mounting Location: Wall
 Subcategory: Up/Down Light

PHYSICAL

Shape: Abstract
 Length (mm): 280
 Length (in): 11
 Width (mm): 85
 Width (in): 3 3/8
 Height (mm): 140
 Height (in): 5 1/2
 Light Distribution: Direct / Indirect
 Weight (kg): 1.7
 Weight (lbs): 3.75
 Diffuser: Frosted tempered glass
 Gasket: Silicon rubber
 Fixture Finish: BLK
 Fixture Material: Aluminum Die Cast

ELECTRICAL

Lamp Type: LED (Zhaga Standard)
 Input Wattage (W): 14
 Total Output Wattage (W): 12
 Dimming: Non-Dimmable
 Driver Included: Yes
 Driver Location: Integrated
 Driver Type: Constant Voltage - 120Vac
 Driver Class: Class 2
 Input Voltage (V): 120
 Output Voltage (V): 24
 Upon Request: (Not included - see components) Remote: 0-10Vdc dimming / Phase dimming @120Vac only / Non-dimming 120/277Vac

LED

Color Temperature (°K): 3000 / 4000 / 6000
 Max. Delivered Lumen (lm): 893.6 / 935.1 / 997.5
 Nominal Lumen (lm): 1290 / 1350 / 1440
 CRI: >85 CRI
 Lamp Life (hrs): 50000

OPTICAL

Beam Angle: Symmetric

RATINGS AND CERTIFICATIONS

Certified By: Certified for North American Standards
 IP rating: IP65

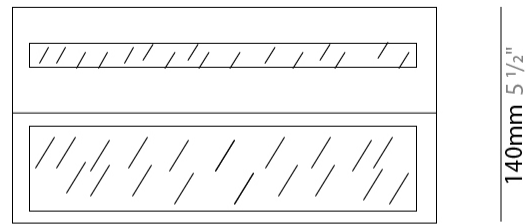
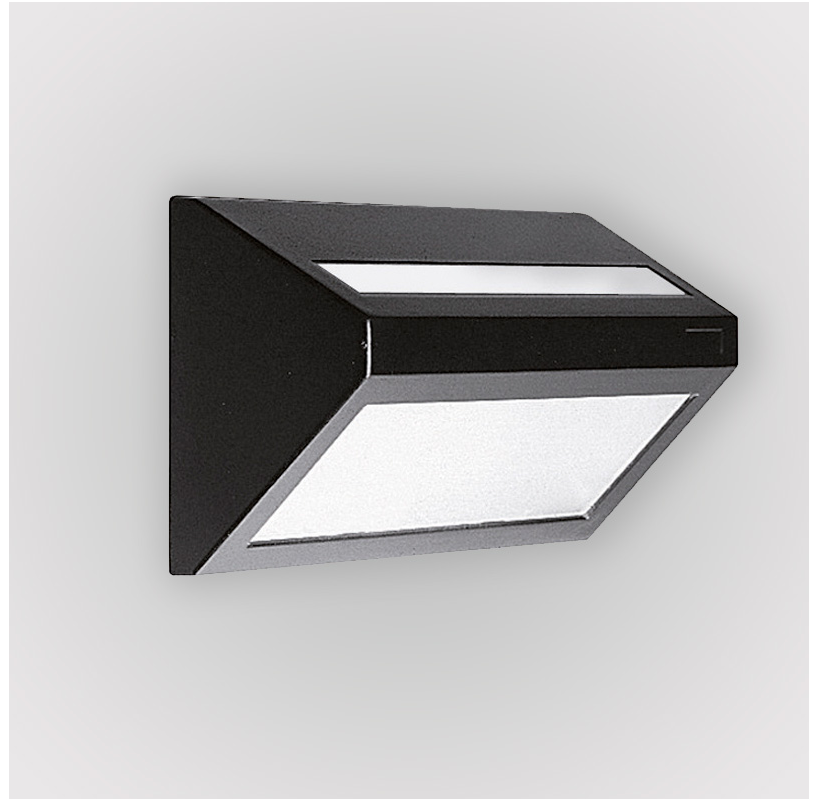

280mm 11"

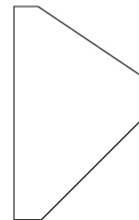

85mm
3 3/8"



1.8kg/
3.97lbs



APPLY 2 SURFACE

E10W0134-

PROJECT	_____
TYPE	_____
SPECIFIER	_____
QUANTITY	_____
DATE	_____

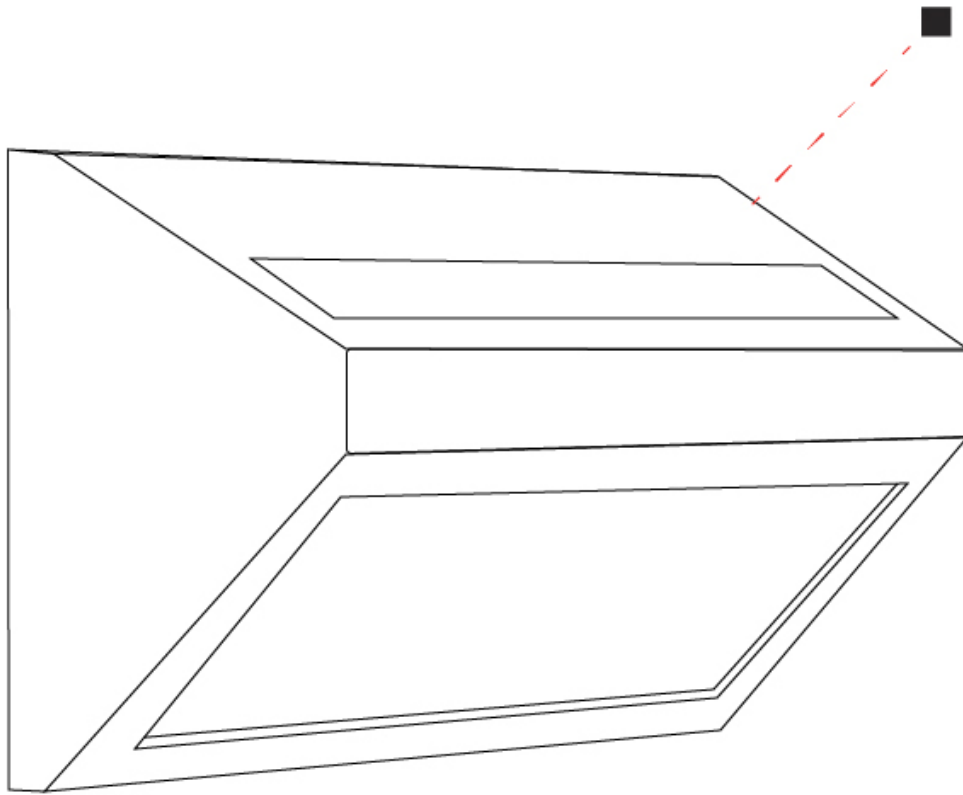

APPLY COLOR FINISH CHART

PROJECT

TYPE

SPECIFIER

QUANTITY

DATE

Fixture Finish

Black - BLK



Brown - BRN

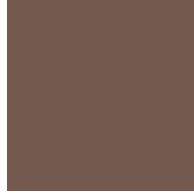

Gray - GRY



Digital: Not all screens are calibrated the same, and therefore, colors will appear differently between screens.

Physical: When texture is involved, there will be variations in color, character and tone within a product series and between product families.













LEGEND

 floor-mounted	 pivotable	 special LED (upon request) RGB, RGBW, tunable, gold+, meat+, art+, fashion+
 wall and ceiling: recessed and surface mounted	 rotating	 warm dim / natural dimming LED
 ceiling-mounted and wall-mounted	 illuminate tilted	 rechargeable battery powered
 wall-mounted	 color of suspension cable	 fixture with natural vivid LED (upon request)
 omni-directional light distribution	 length of suspension cable	 color rendering index
 direct light distribution	 reflector degree selection	 color temperature
 direct/indirect light distribution	 super spot	 lumen (luminous flux)
 indirect light distribution	 lens	 efficacy (lumens per watt)
 asymmetric light distribution	 lens pack	 Unified Glare Rating (UGR) range from 5-40
 aura light distribution	 shine ring	 marine grade (AISI 316 stainless steel)
 round wall or ceiling cut-out	 integrated shine ring with diffuser	 walk on
 square wall or ceiling cut-out	 free individual colors 01-29	 drive on
 the supplied jig specifies the cutout dimensions	 individual colors: 00 (free of charge), 01-25 (extra charge)	 Dark Sky Compliance
 minimum distance (meters) lamp - object	 luminaire part to be colored (F1)	 Americans with Disabilities Act (less than 4" off the wall located between 27"-84" from floor)
 recessed depth	 luminaire part to be colored (F2)	 lamp protected against explosion
 ceiling thickness in mm	 luminaire part to be colored (F3)	 blown glass using traditional methods by master glass blower
 ceiling thickness selection	 luminaire part to be colored (F4)	 acoustic material
 dimmable DP (phase), DV (0-10V), DD (dali), DS (step-dim)	 luminaire part to be colored (F5)	 protection class I, protection insulation
 included or excluded LED driver/transformer/control gear	 color of 3-circuit adaptor	 protection class II, protection insulation
 separately switchable	 indirect diffuser	 ETL Certified to UL and CSA Standards
 sensor	 direct diffuser	 UL Certified to UL and CSA Standards
 remote control	 ball-proof (upon request)	 CSA Certified to UL and CSA Standards
 available upon request	 accessory	 Certified for North American Standards

IP RATING

 IP20	protected against ingress of solid bodies greater than 12.5mm (finger)
 IP33	protected against ingress of solid bodies greater than 2.5mm protected against sprays of water up to 60 degrees from the vertical (rain)
 IP40	protected against ingress of solid bodies greater than 1mm (wire) no protection against the ingress of moisture
 IP43	protected against ingress of solid bodies greater than 1mm (wire) protected against sprays of water up to 60 degrees from the vertical (rain)
 IP44	protected against ingress of solid bodies greater than 1mm (wire) protected against water splashed from all directions
 IP54	protected against limited ingress of dust (wet rooms/covered outdoor areas) protected against water splashed from all directions
 IP65	protected against ingress of dust protected against jets of water
 IP66	protected against ingress of dust protected against powerful jets of water or heavy seas
 IP67	protected against ingress of dust protected against immersion of water between 15cm - 1m for 30 minutes
 IP68	protected against ingress of dust protected against immersion of water under pressure for long periods

IK RATING

 IK01	protected against 0.14 joules impact (equivalent to 0.25kg mass dropped from 56mm above the surface)
 IK02	protected against 0.2 joules impact (equivalent to 0.25kg mass dropped from 80mm above the surface)
 IK03	protected against 0.35 joules impact (equivalent to 0.25kg mass dropped from 140mm above the surface)
 IK04	protected against 0.5 joules impact (equivalent to 0.25kg mass dropped from 200mm above the surface)
 IK05	protected against 0.7 joules impact (equivalent to 0.25kg mass dropped from 280mm above the surface)
 IK06	protected against 1 joules impact (equivalent to 0.25kg mass dropped from 400mm above the surface)
 IK07	protected against 2 joules impact (equivalent to 0.5kg mass dropped from 400mm above the surface)
 IK08	protected against 5 joules impact (equivalent to 1.7kg mass dropped from 300mm above the surface)
 IK09	protected against 10 joules impact (equivalent to 5.0kg mass dropped from 200mm above the surface)
 IK10	protected against 20 joules impact (equivalent to 5.0kg mass dropped from 400mm above the surface)