

ASTER RECESSED

E9Q117- _____ - _____
 base number Color Finish
 Temperature Options

- To build a product code in our configurator select the specify button on the base model # product page
- To build a manual product code on this datasheet choose from the options listed below in blue font and add the suffix to the base model #

GENERAL

Series: Aster
 Partner: Platek
 Division: Exterior
 Installation: Recessed
 Product Type: Downlight
 Mounting Location: Ceiling
 Light Distribution: Downlight

PHYSICAL

Aperture Sizes - Downlights: 2"
 Shape: Round
 Diameter (mm): 113
 Diameter (in): 4 7/16"
 Height (mm): 83
 Height (in): 3 1/4"
 Diffuser: Clear tempered glass
 Fixture Finish: [BLK / WHI / GRY / COR / ANT / BRZ](#)
 Fixture Material: Aluminum Die Cast
 Cut-out Measurements: 95mm / 3 3/4" diameter

ELECTRICAL

Lamp Type: LED
 Input Wattage (W): 9.9
 Total Output Wattage (W): 8.5
 Dimming: Tri-Mode (Non-Dimming and Phase Dimming (120Vac only) and 0-10V Dimming)
 Driver Included: No
 Driver Location: Remote
 Driver Type: Constant Current - 120 / 277Vac
 Driver Class: Class 2
 Housing: ENCP3
 Input Voltage (V): 120 - 277
 Constant Current (MA): 250

LED

Number of LEDs: 1
 Color Temperature (°K): [2700 / 3000 / 4000](#)
 Max. Delivered Lumen (lm): Max 1185lm
 CRI: >80 CRI
 Lamp Life (hrs): 60000

OPTICAL

Beam Angle: Asymmetric

RATINGS AND CERTIFICATIONS

Certified By: Certified for North American Standards
 IP rating: IP65
 IK Rating: IK07
 Upon Request: Higher Maximum Ambient Temperature



Ø113mm 4 7/16"

Ø72mm 2 13/16"

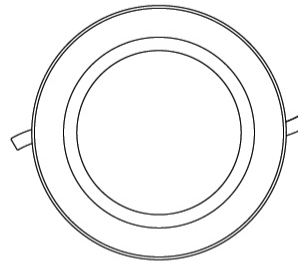

Ø150mm 5 7/8"

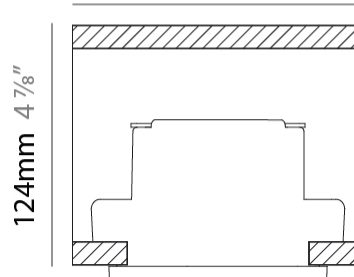

ASTER RECESSED

E9Q117-

PROJECT _____

TYPE _____

SPECIFIER _____

QUANTITY _____

DATE _____

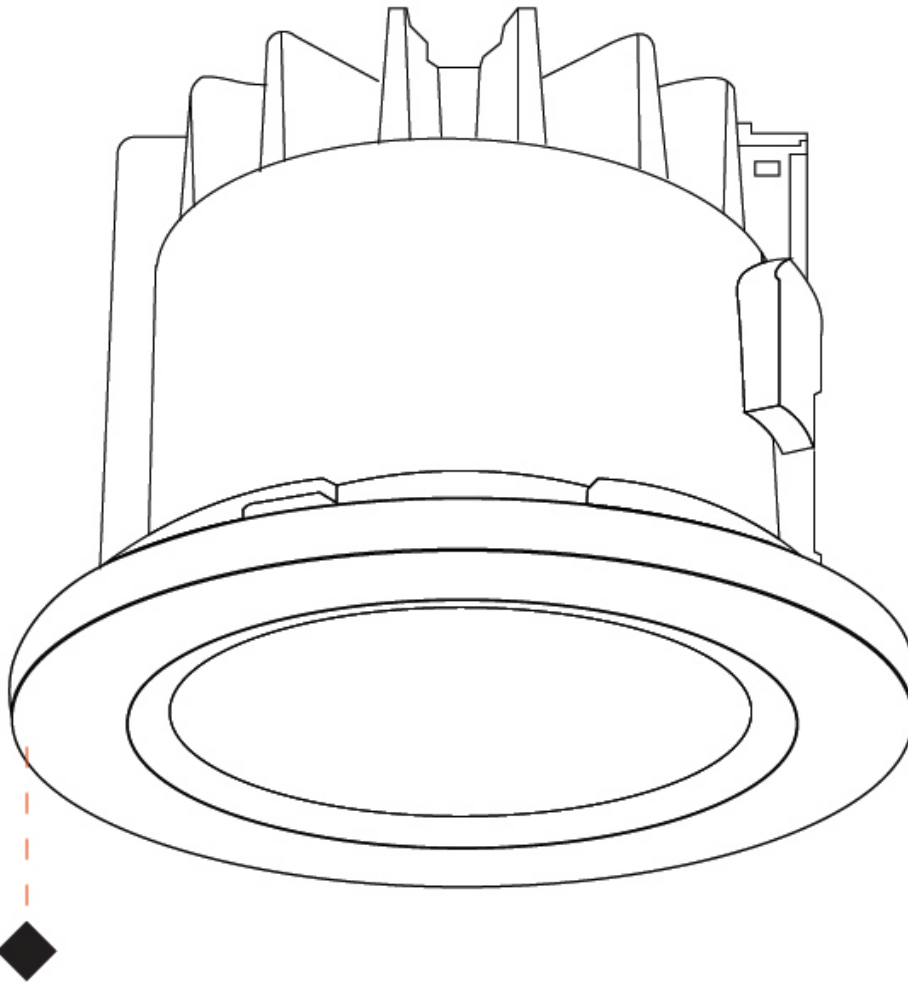

E

PROJECT	_____
TYPE	_____
SPECIFIER	_____
QUANTITY	_____
DATE	_____

ASTER RECESSED

E9Q118-

base number Color Finish Lens
 Temperature Options Options

- To build a product code in our configurator select the specify button on the base model # product page
- To build a manual product code on this datasheet choose from the options listed below in blue font and add the suffix to the base model #

GENERAL

Series: Aster
 Partner: Platek
 Division: Exterior
 Installation: Recessed
 Product Type: Downlight
 Mounting Location: Ceiling
 Light Distribution: Downlight

PHYSICAL

Aperture Sizes - Downlights: 2"
 Shape: Round
 Diameter (mm): 113
 Diameter (in): 4 7/16"
 Height (mm): 83
 Height (in): 3 1/4"
 Diffuser: Clear tempered glass
 Fixture Finish: [BLK / WHI / GRY / COR / ANT / BRZ](#)
 Fixture Material: Aluminum Die Cast
 Cut-out Measurements: 95mm / 3 3/4" diameter

ELECTRICAL

Lamp Type: LED
 Input Wattage (W): 9.9
 Total Output Wattage (W): 8.5
 Dimming: Tri-Mode (Non-Dimming and Phase Dimming (120Vac only) and 0-10V Dimming)
 Driver Included: No
 Driver Location: Remote
 Driver Type: Constant Current - 120 / 277Vac
 Driver Class: Class 2
 Housing: ENCP 3
 Input Voltage (V): 120 - 277
 Constant Current (MA): 250

LED

Color Temperature (°K): [2700 / 3000 / 4000](#)
 Max. Delivered Lumen (lm): Max 1680lm
 CRI: >80 CRI
 Lamp Life (hrs): 60000

OPTICAL

Optic°: [13 / 32 / 60](#)

RATINGS AND CERTIFICATIONS

Certified By: Certified for North American Standards
 IP rating: IP65
 IK Rating: IK07
 Upon Request: Higher Maximum Ambient Temperature



Ø113mm 4 7/16"

Ø72mm 2 13/16"

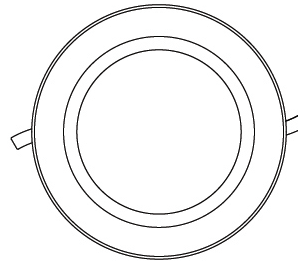

Ø150mm 5 7/8"

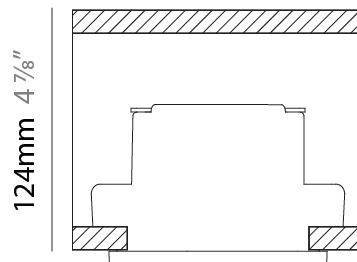

ASTER RECESSED

E9Q118-

PROJECT _____

TYPE _____

SPECIFIER _____

QUANTITY _____

DATE _____

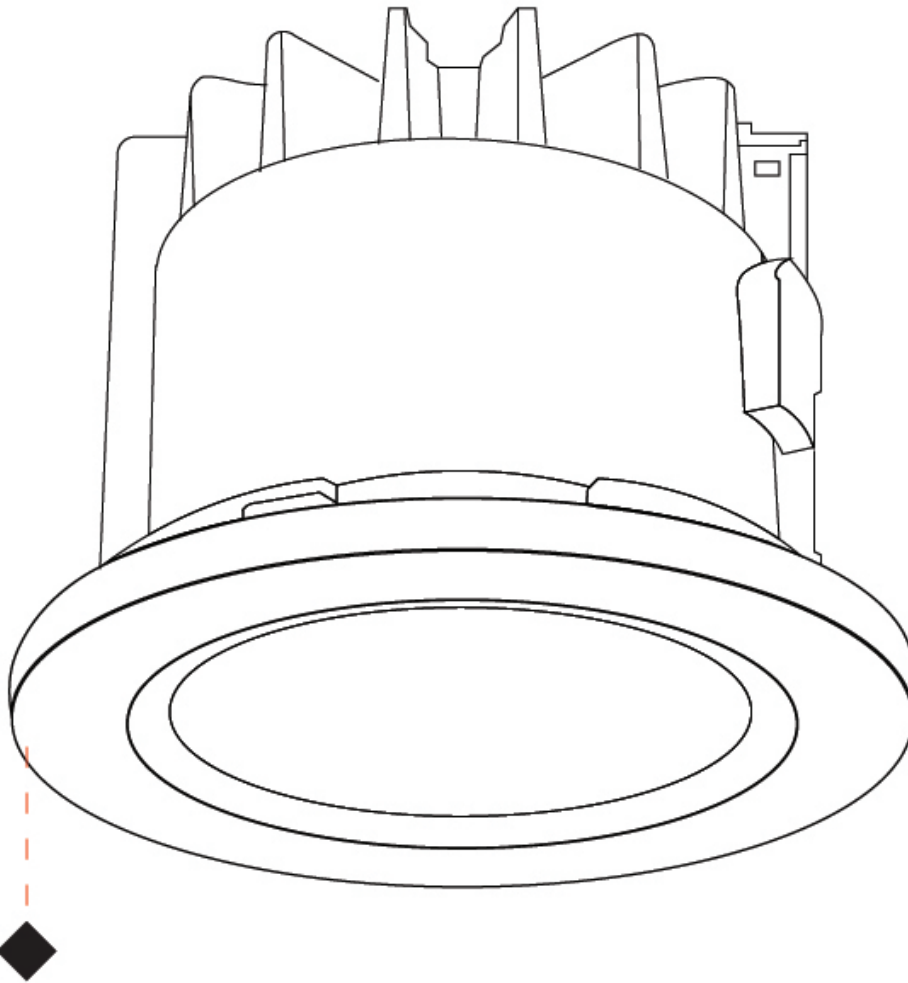

E

PROJECT	_____
TYPE	_____
SPECIFIER	_____
QUANTITY	_____
DATE	_____

ASTER RECESSED

E9Q122-

base number Color Finish Lens
 Temperature Options Options

- To build a product code in our configurator select the specify button on the base model # product page
- To build a manual product code on this datasheet choose from the options listed below in blue font and add the suffix to the base model #

GENERAL

Series: Aster
 Partner: Platek
 Division: Exterior
 Installation: Recessed
 Product Type: Downlight
 Mounting Location: Ceiling
 Light Distribution: Downlight

PHYSICAL

Aperture Sizes - Downlights: 4"
 Shape: Round
 Diameter (mm): 149
 Diameter (in): 5 7/8"
 Height (mm): 109
 Height (in): 4 3/16"
 Diffuser: Clear tempered glass
 Fixture Finish: [BLK / WHI / GRY / COR / ANT / BRZ](#)
 Fixture Material: Aluminum Die Cast
 Cut-out Measurements: 131mm / 5 3/16" diameter

ELECTRICAL

Lamp Type: LED
 Input Wattage (W): 23.5
 Total Output Wattage (W): 20.3
 Dimming: Tri-Mode (Non-Dimming and Phase Dimming (120Vac only) and 0-10V Dimming)
 Driver Included: No
 Driver Location: Remote
 Driver Type: Constant Current - 120 / 277Vac
 Driver Class: Class 2
 Housing: ENCP 1
 Input Voltage (V): 120 - 277
 Constant Current (MA): 600

LED

Color Temperature (°K): [2700 / 3000 / 4000](#)
 Max. Delivered Lumen (lm): Max 3290lm
 CRI: >80 CRI
 Lamp Life (hrs): 60000

OPTICAL

Optic°: [10 / 35 / 67](#)

RATINGS AND CERTIFICATIONS

Certified By: Certified for North American Standards
 IP rating: IP65
 IK Rating: IK07
 Upon Request: Higher Maximum Ambient Temperature



Ø149mm 5 7/8"

Ø106mm 4 3/16"

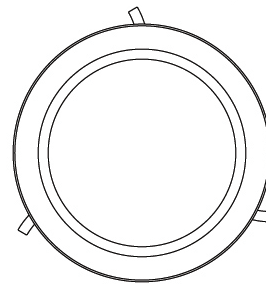

Ø220mm 8 11/16"

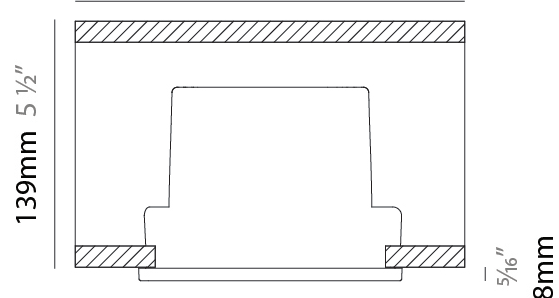

ASTER RECESSED

E9Q122-

PROJECT _____

TYPE _____

SPECIFIER _____

QUANTITY _____

DATE _____

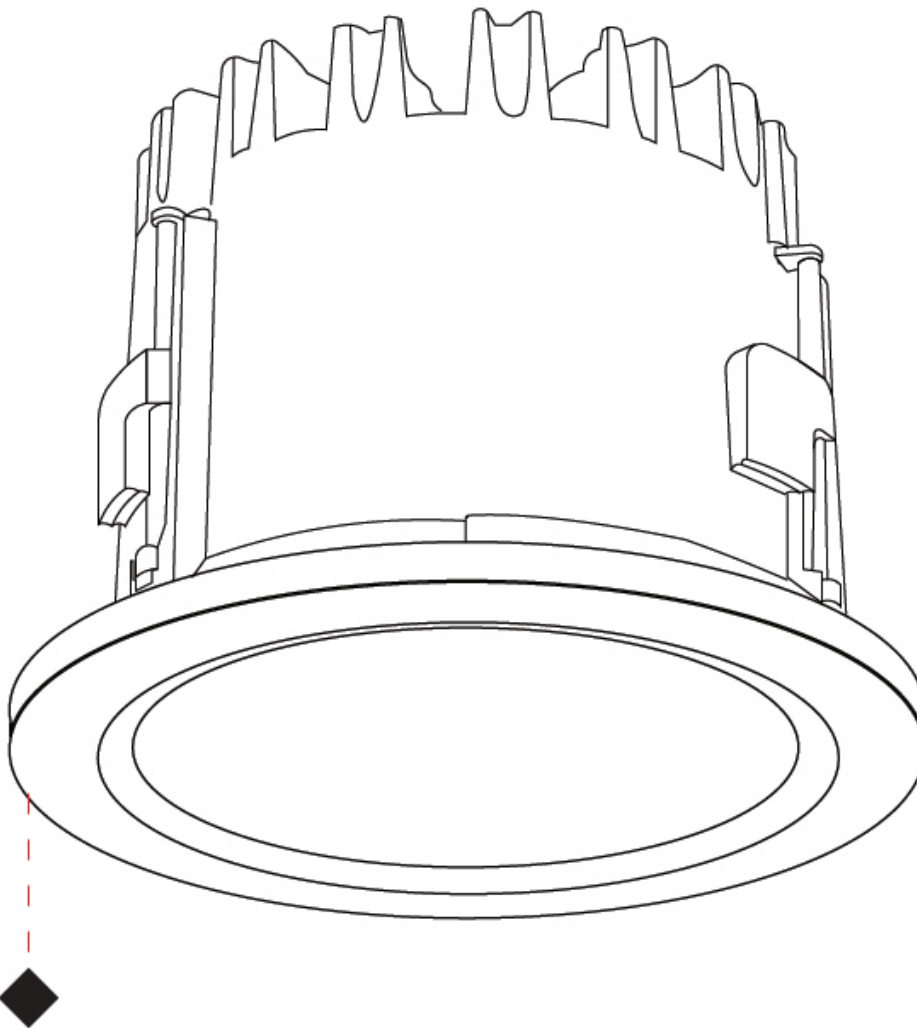

E

PROJECT	_____
TYPE	_____
SPECIFIER	_____
QUANTITY	_____
DATE	_____

ASTER RECESSED

E9Q123-

base number
 Color Temperature Finish Options

- To build a product code in our configurator select the specify button on the base model # product page
- To build a manual product code on this datasheet choose from the options listed below in blue font and add the suffix to the base model #

GENERAL

Series: Aster
 Partner: Platek
 Division: Exterior
 Installation: Recessed
 Product Type: Downlight
 Mounting Location: Ceiling
 Light Distribution: Downlight

PHYSICAL

Aperture Sizes - Downlights: 4"
 Shape: Round
 Diameter (mm): 149
 Diameter (in): 5 7/8"
 Height (mm): 109
 Height (in): 4 3/16"
 Diffuser: Clear tempered glass
 Fixture Finish: [BLK / WHI / GRY / COR / ANT / BRZ](#)
 Fixture Material: Aluminum Die Cast
 Cut-out Measurements: 131mm / 5 3/16" diameter

ELECTRICAL

Lamp Type: LED
 Input Wattage (W): 23.5
 Total Output Wattage (W): 20.3
 Dimming: Tri-Mode (Non-Dimming and Phase Dimming (120Vac only) and 0-10V Dimming)
 Driver Included: No
 Driver Location: Remote
 Driver Type: Constant Current - 120 / 277Vac
 Driver Class: Class 2
 Housing: ENCP 1
 Input Voltage (V): 120 - 277
 Constant Current (MA): 600

LED

Number of LEDs: 1
 Color Temperature (°K): [2700 / 3000 / 4000](#)
 Max. Delivered Lumen (lm): Max 3410m
 CRI: >80 CRI
 Lamp Life (hrs): 60000

OPTICAL

Beam Angle: Asymmetric

RATINGS AND CERTIFICATIONS

Certified By: Certified for North American Standards
 IP rating: IP65
 IK Rating: IK07
 Upon Request: Higher Maximum Ambient Temperature



Ø149mm 5 7/8"

Ø106mm 4 3/16"

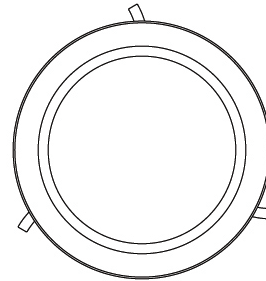

Ø220mm 8 11/16"

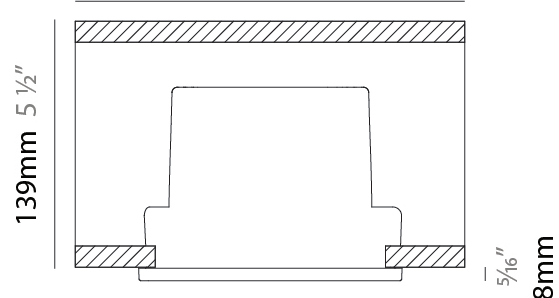

ASTER RECESSED

E9Q123-

PROJECT	_____
TYPE	_____
SPECIFIER	_____
QUANTITY	_____
DATE	_____

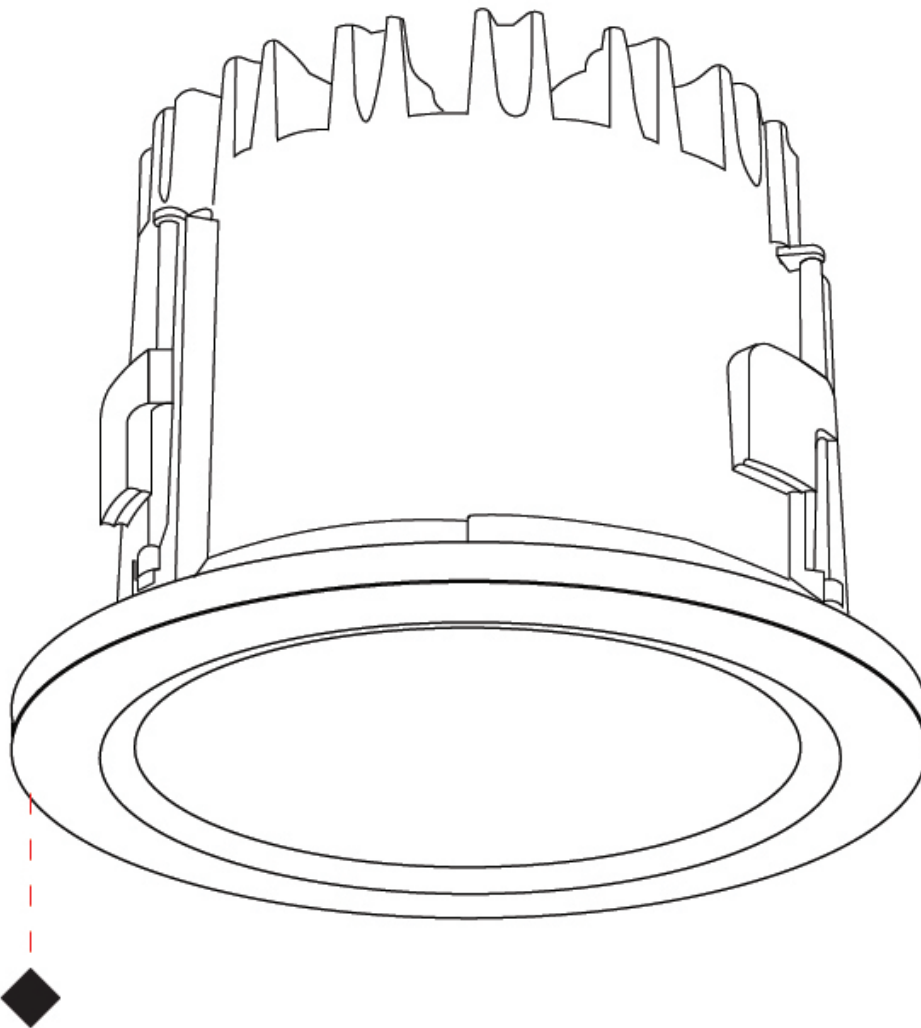

E

PROJECT	_____
TYPE	_____
SPECIFIER	_____
QUANTITY	_____
DATE	_____

ASTER RECESSED

E9Q127-

base number Color Finish Lens
 Temperature Options Options

- To build a product code in our configurator select the specify button on the base model # product page
- To build a manual product code on this datasheet choose from the options listed below in blue font and add the suffix to the base model #

GENERAL

Series: Aster
 Partner: Platek
 Division: Exterior
 Installation: Recessed
 Product Type: Downlight
 Mounting Location: Ceiling
 Light Distribution: Downlight

PHYSICAL

Aperture Sizes - Downlights: 6"
 Shape: Round
 Diameter (mm): 209
 Diameter (in): 8 ¼"
 Height (mm): 117
 Height (in): 4 ⅝"
 Diffuser: Clear tempered glass
 Fixture Finish: [BLK / WHI / GRY / COR / ANT / BRZ](#)
 Fixture Material: Aluminum Die Cast
 Cut-out Measurements: 191mm / 7 1/2" diameter

ELECTRICAL

Lamp Type: LED
 Input Wattage (W): 42
 Total Output Wattage (W): 36
 Dimming: Tri-Mode (Non-Dimming and Phase Dimming (120Vac only) and 0-10V Dimming)
 Driver Included: No
 Driver Location: Remote
 Driver Type: Constant Current - 120 / 277Vac
 Driver Class: Class 2
 Housing: ENCP 1
 Input Voltage (V): 120 - 277
 Constant Current (MA): 1050

LED

Color Temperature (°K): [2700 / 3000 / 4000](#)
 Max. Delivered Lumen (lm): Max 5870lm
 CRI: >80 CRI
 Lamp Life (hrs): 60000

OPTICAL

Optic°: [10 / 38 / 80](#)

RATINGS AND CERTIFICATIONS

Certified By: Certified for North American Standards
 IP rating: IP65
 IK Rating: IK07
 Upon Request: Higher Maximum Ambient Temperature



Ø210mm 8 ¼"

Ø165mm 6 ½"

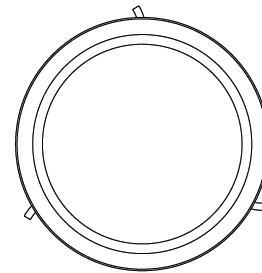

Ø347mm 13 1/16"

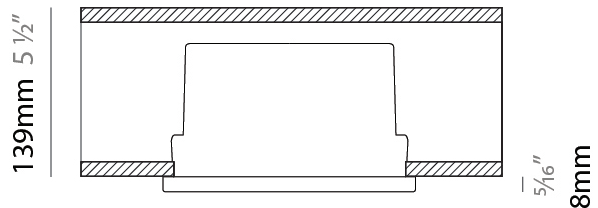

ASTER RECESSED

E9Q127-

PROJECT _____

TYPE _____

SPECIFIER _____

QUANTITY _____

DATE _____

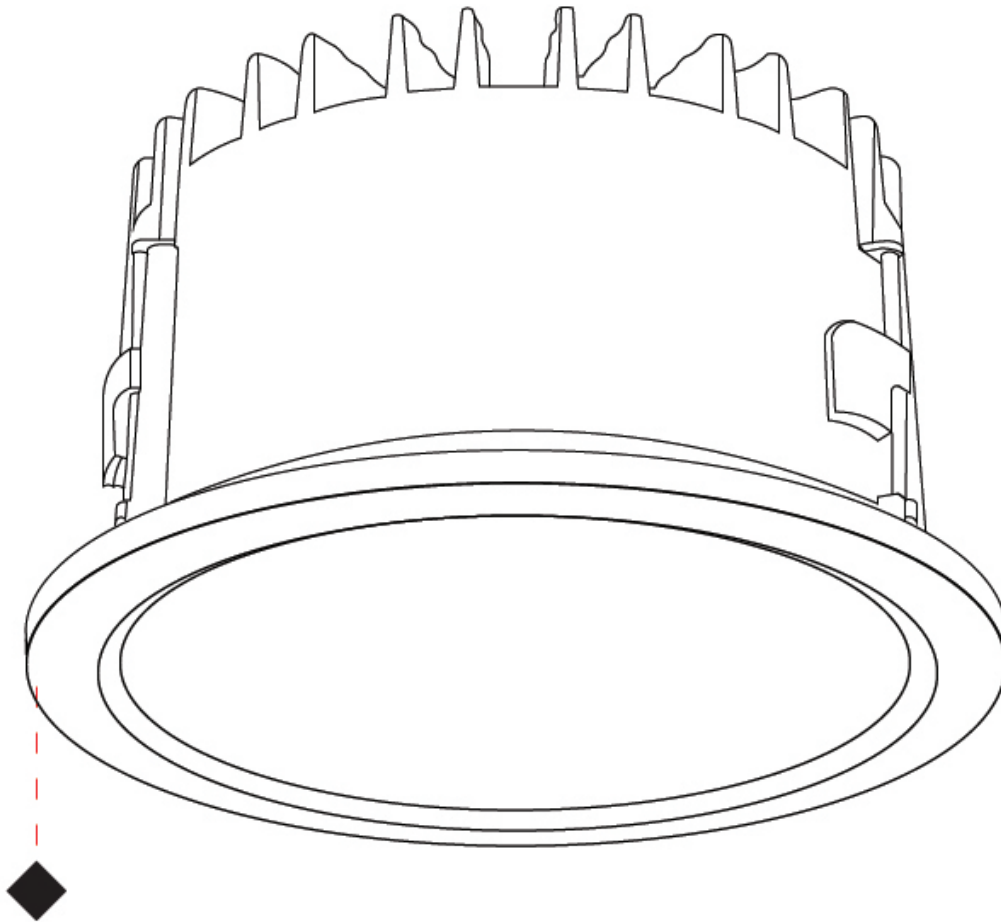

E

PROJECT	_____
TYPE	_____
SPECIFIER	_____
QUANTITY	_____
DATE	_____

ASTER RECESSED

E9Q128-

base number
 Color Temperature Finish Options

- To build a product code in our configurator select the specify button on the base model # product page
- To build a manual product code on this datasheet choose from the options listed below in blue font and add the suffix to the base model #

GENERAL

Series: Aster
 Partner: Platek
 Division: Exterior
 Installation: Recessed
 Product Type: Downlight
 Mounting Location: Ceiling
 Light Distribution: Downlight

PHYSICAL

Aperture Sizes - Downlights: 6"
 Shape: Round
 Diameter (mm): 209
 Diameter (in): 8 ¼"
 Height (mm): 117
 Height (in): 4 ⅝"
 Diffuser: Clear tempered glass
 Fixture Finish: [BLK / WHI / GRY / COR / ANT / BRZ](#)
 Fixture Material: Aluminum Die Cast
 Cut-out Measurements: 191mm / 7 1/2" diameter

ELECTRICAL

Lamp Type: LED
 Input Wattage (W): 42
 Total Output Wattage (W): 36
 Dimming: Tri-Mode (Non-Dimming and Phase Dimming (120Vac only) and 0-10V Dimming)
 Driver Included: No
 Driver Location: Remote
 Driver Type: Constant Current - 120 / 277Vac
 Driver Class: Class 2
 Housing: ENCP 1
 Input Voltage (V): 120 - 277
 Constant Current (MA): 1050

LED

Number of LEDs: 1
 Color Temperature (°K): [2700 / 3000 / 4000](#)
 Max. Delivered Lumen (lm): Max 5870m
 CRI: >80 CRI
 Lamp Life (hrs): 60000

OPTICAL

Beam Angle: Asymmetric

RATINGS AND CERTIFICATIONS

Certified By: Certified for North American Standards
 IP rating: IP65
 IK Rating: IK07
 Upon Request: Higher Maximum Ambient Temperature



Ø210mm 8 ¼"

Ø165mm 6 ½"

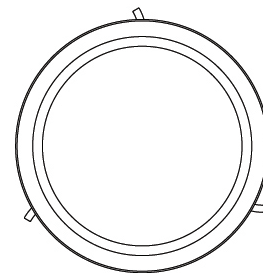

Ø347mm 13 1/16"

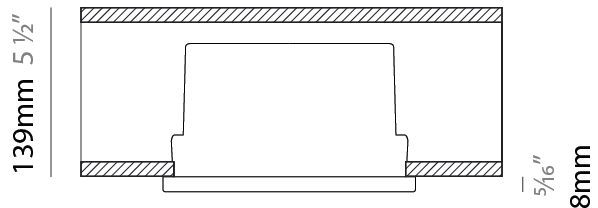

ASTER RECESSED

E9Q128-

PROJECT _____

TYPE _____

SPECIFIER _____

QUANTITY _____

DATE _____

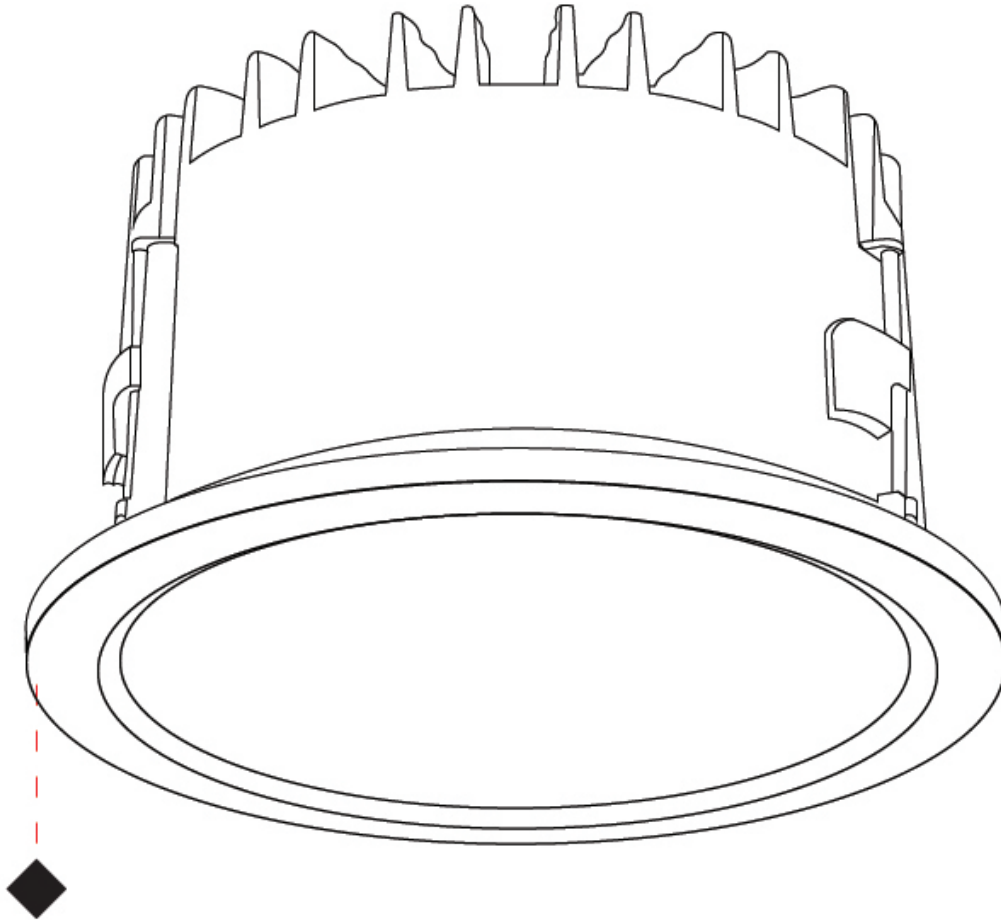

E

ASTER COLOR FINISH CHART

PROJECT	_____
TYPE	_____
SPECIFIER	_____
QUANTITY	_____
DATE	_____

Fixture Finish

Black - BLK

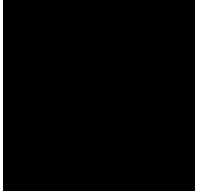

White - WHI

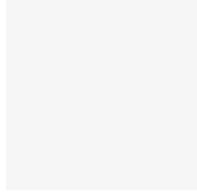

Grey - GRY

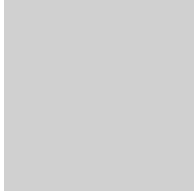

Corten - COR



Anthracite - ANT



Bronze - BRZ



Digital: Not all screens are calibrated the same, and therefore, colors will appear differently between screens.











Physical: When texture is involved, there will be variations in color, character and tone within a product series and between product families.













LEGEND

	floor-mounted		pivotal		special LED (upon request) RGB, RGBW, tunable, gold+, meat+, art+, fashion+
	wall and ceiling: recessed and surface mounted		rotating		warm dim / natural dimming LED
	ceiling-mounted and wall-mounted		illuminate tilted		rechargeable battery powered
	wall-mounted		color of suspension cable		fixture with natural vivid LED (upon request)
	omni-directional light distribution		length of suspension cable		color rendering index
	direct light distribution		reflector degree selection		color temperature
	direct/indirect light distribution		super spot		lumen (luminous flux)
	indirect light distribution		lens		efficacy (lumens per watt)
	asymmetric light distribution		lens pack		Unified Glare Rating (UGR) range from 5-40
	aura light distribution		shine ring		marine grade (AISI 316 stainless steel)
	round wall or ceiling cut-out		integrated shine ring with diffuser		walk on
	square wall or ceiling cut-out		free individual colors 01-29		drive on
	the supplied jig specifies the cutout dimensions		individual colors: 00 (free of charge), 01-25 (extra charge)		Dark Sky Compliance
	minimum distance (meters) lamp - object		luminaire part to be colored (F1)		Americans with Disabilities Act (less than 4" off the wall located between 27"-84" from floor)
	recessed depth		luminaire part to be colored (F2)		lamp protected against explosion
	ceiling thickness in mm		luminaire part to be colored (F3)		blown glass using traditional methods by master glass blower
	ceiling thickness selection		luminaire part to be colored (F4)		acoustic material
	dimmable DP (phase), DV (0-10V), DD (dali), DS (step-dim)		luminaire part to be colored (F5)		protection class I, protection insulation
	included or excluded LED driver/transformer/control gear		color of 3-circuit adaptor		protection class II, protection insulation
	separately switchable		indirect diffuser		ETL Certified to UL and CSA Standards
	sensor		direct diffuser		UL Certified to UL and CSA Standards
	remote control		ball-proof (upon request)		CSA Certified to UL and CSA Standards
	available upon request		accessory		Certified for North American Standards

IP RATING

	protected against ingress of solid bodies greater than 12.5mm (finger)
	protected against ingress of solid bodies greater than 2.5mm protected against sprays of water up to 60 degrees from the vertical (rain)
	protected against ingress of solid bodies greater than 1mm (wire) no protection against the ingress of moisture
	protected against ingress of solid bodies greater than 1mm (wire) protected against sprays of water up to 60 degrees from the vertical (rain)
	protected against ingress of solid bodies greater than 1mm (wire) protected against water splashed from all directions
	protected against limited ingress of dust (wet rooms/covered outdoor areas) protected against water splashed from all directions
	protected against ingress of dust protected against jets of water
	protected against ingress of dust protected against powerful jets of water or heavy seas
	protected against ingress of dust protected against immersion of water between 15cm - 1m for 30 minutes
	protected against ingress of dust protected against immersion of water under pressure for long periods

IK RATING

	protected against 0.14 joules impact (equivalent to 0.25kg mass dropped from 56mm above the surface)
	protected against 0.2 joules impact (equivalent to 0.25kg mass dropped from 80mm above the surface)
	protected against 0.35 joules impact (equivalent to 0.25kg mass dropped from 140mm above the surface)
	protected against 0.5 joules impact (equivalent to 0.25kg mass dropped from 200mm above the surface)
	protected against 0.7 joules impact (equivalent to 0.25kg mass dropped from 280mm above the surface)
	protected against 1 joules impact (equivalent to 0.25kg mass dropped from 400mm above the surface)
	protected against 2 joules impact (equivalent to 0.5kg mass dropped from 400mm above the surface)
	protected against 5 joules impact (equivalent to 1.7kg mass dropped from 300mm above the surface)
	protected against 10 joules impact (equivalent to 5.0kg mass dropped from 200mm above the surface)
	protected against 20 joules impact (equivalent to 5.0kg mass dropped from 400mm above the surface)