

PROJECT	
TYPE	
SPECIFIER	
QUANTITY	
DATE	

## ASTROS SUSPENSION

### D91219

base number

- To build a product code in our configurator select the specify button on the base model # product page
- To build a manual product code on this datasheet choose from the options listed below in blue font and add the suffix to the base model #

#### GENERAL

Series: Astros  
 Partner: Milan  
 Division: Design  
 Installation: Suspension  
 Product Type: Pendant  
 Mounting Location: Ceiling

#### PHYSICAL

Shape: Oval  
 Diameter (mm): 150  
 Diameter (in): 5 7/8  
 Height (mm): 460  
 Height (in): 18 1/8  
 Max. Overall Height (mm): 1600  
 Max. Overall Height (in): 63  
 Weight (kg): 1.2  
 Weight (lbs): 2.499  
 Diffuser: Glass - Opal  
 Fixture Finish: MBQ  
 Fixture Material: Glass / Metal  
 Primary Material: Glass  
 Cable Details: 1600mm/63" Cable

#### ELECTRICAL

Number of Lamps: 2  
 Lamp Type: LED Retrofit  
 Bulb Included: Bulb Not Included  
 Total Output Wattage (W): 4.8  
 Max. Wattage Per Lamp (W): 4.8  
 Lamp Base: G9  
 Input Voltage (V): 120

#### LED

#### OPTICAL

#### RATINGS AND CERTIFICATIONS

Certified By: CSA Certified to UL and CSA Standards  
 IP rating: IP20



Ø150mm 5 7/8"

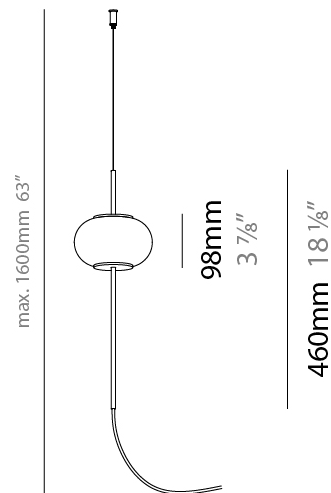

PROJECT	
TYPE	
SPECIFIER	
QUANTITY	
DATE	

## ASTROS SUSPENSION

### D91220

base number

- To build a product code in our configurator select the specify button on the base model # product page
- To build a manual product code on this datasheet choose from the options listed below in blue font and add the suffix to the base model #

#### GENERAL

Series: Astros  
 Partner: Milan  
 Division: Design  
 Installation: Suspension  
 Product Type: Pendant  
 Mounting Location: Ceiling

#### PHYSICAL

Shape: Oval  
 Diameter (mm): 150  
 Diameter (in): 5 <sup>7</sup>/<sub>8</sub>  
 Height (mm): 460  
 Height (in): 18 <sup>1</sup>/<sub>8</sub>  
 Max. Overall Height (mm): 3000  
 Max. Overall Height (in): 118 <sup>1</sup>/<sub>8</sub>  
 Weight (kg): 1.8  
 Weight (lbs): 3.999  
 Diffuser: Glass - Opal  
 Fixture Finish: MBQ  
 Fixture Material: Glass / Metal  
 Primary Material: Glass  
 Cable Details: 2540mm/100" Cable

#### ELECTRICAL

Number of Lamps: 2  
 Lamp Type: LED Retrofit  
 Bulb Included: Bulb Not Included  
 Total Output Wattage (W): 9.6  
 Max. Wattage Per Lamp (W): 4.8  
 Lamp Base: G9  
 Input Voltage (V): 120

#### LED

#### OPTICAL

#### RATINGS AND CERTIFICATIONS

Certified By: CSA Certified to UL and CSA Standards  
 IP rating: IP20

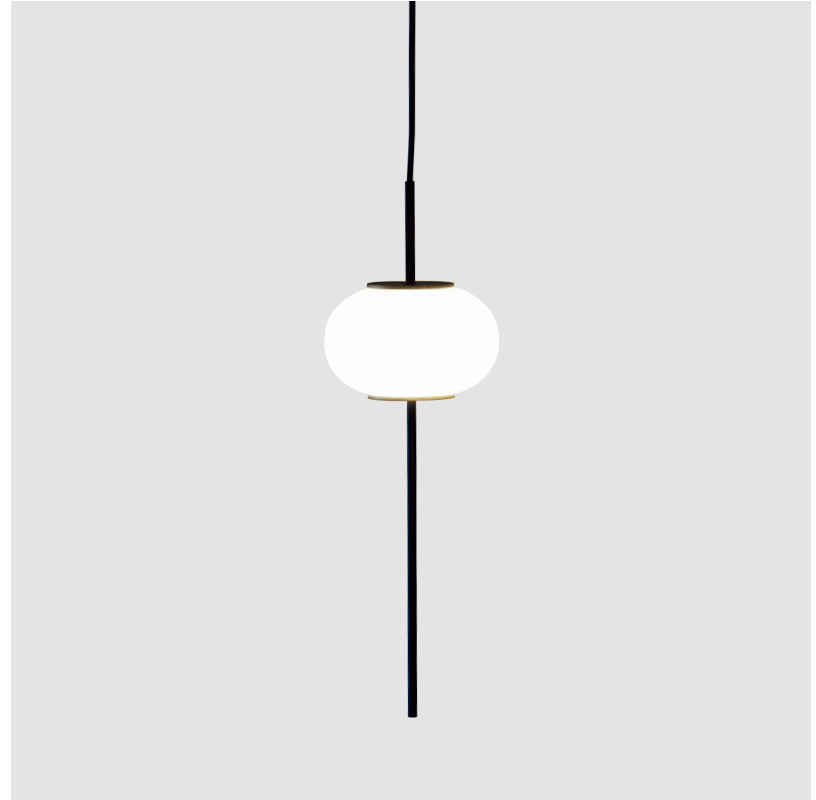

PROJECT	
TYPE	
SPECIFIER	
QUANTITY	
DATE	

## ASTROS SUSPENSION

### D91221

base number

- To build a product code in our configurator select the specify button on the base model # product page
- To build a manual product code on this datasheet choose from the options listed below in blue font and add the suffix to the base model #

#### GENERAL

Series: Astros  
 Partner: Milan  
 Division: Design  
 Installation: Suspension  
 Product Type: Pendant  
 Mounting Location: Ceiling

#### PHYSICAL

Shape: Oval  
 Height (mm): 460  
 Height (in): 18 1/8  
 Max. Overall Height (mm): 3000  
 Max. Overall Height (in): 118 1/8  
 Weight (kg): 11.3  
 Weight (lbs): 24.999  
 Diffuser: Glass - Opal  
 Fixture Finish: MBQ  
 Fixture Material: Glass / Metal  
 Primary Material: Glass  
 Cable Details: 2540mm/100" Cable

#### ELECTRICAL

Number of Lamps: 4  
 Lamp Type: LED Retrofit  
 Bulb Included: Bulb Not Included  
 Total Output Wattage (W): 9.6  
 Max. Wattage Per Lamp (W): 4.8  
 Lamp Base: G9  
 Input Voltage (V): 120

#### LED

#### OPTICAL

#### RATINGS AND CERTIFICATIONS

Certified By: CSA Certified to UL and CSA Standards  
 IP rating: IP20

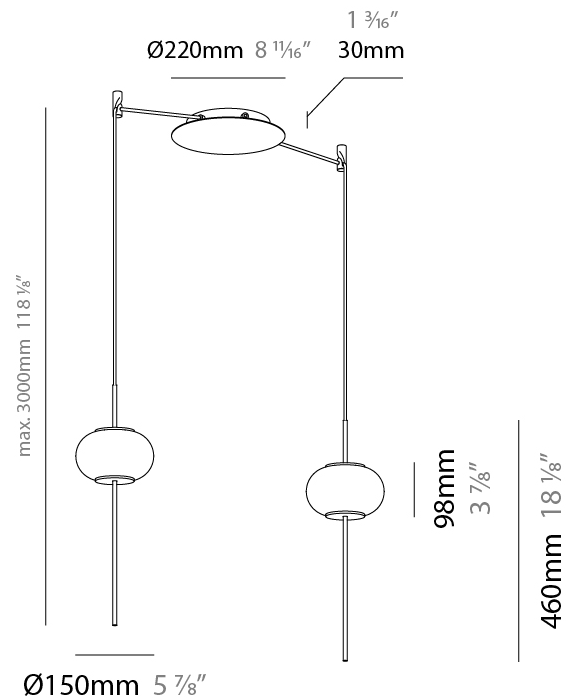

PROJECT	_____
TYPE	_____
SPECIFIER	_____
QUANTITY	_____
DATE	_____

## ASTROS SUSPENSION

### D91223

base number

- To build a product code in our configurator select the specify button on the base model # product page
- To build a manual product code on this datasheet choose from the options listed below in blue font and add the suffix to the base model #

#### GENERAL

Series: Astros  
 Partner: Milan  
 Division: Design  
 Installation: Suspension  
 Product Type: Pendant  
 Mounting Location: Ceiling

#### PHYSICAL

Shape: Oval  
 Height (mm): 460  
 Height (in): 18 1/8  
 Max. Overall Height (mm): 3000  
 Max. Overall Height (in): 118 1/8  
 Weight (kg): 13.5  
 Weight (lbs): 29.799  
 Diffuser: Glass - Opal  
 Fixture Finish: MBQ  
 Fixture Material: Glass / Metal  
 Primary Material: Glass  
 Cable Details: 2540mm/100" Cable

#### ELECTRICAL

Number of Lamps: 8  
 Lamp Type: LED Retrofit  
 Bulb Included: Bulb Not Included  
 Total Output Wattage (W): 38.4  
 Max. Wattage Per Lamp (W): 4.8  
 Lamp Base: G9  
 Input Voltage (V): 120

#### LED

#### OPTICAL

#### RATINGS AND CERTIFICATIONS

Certified By: CSA Certified to UL and CSA Standards  
 IP rating: IP20

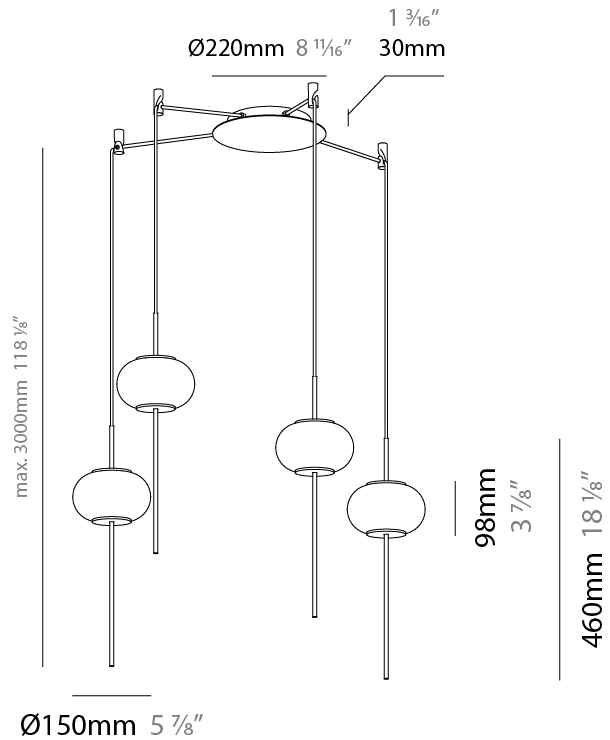

PROJECT	_____
TYPE	_____
SPECIFIER	_____
QUANTITY	_____
DATE	_____

## ASTROS SUSPENSION

### D91224

base number

- To build a product code in our configurator select the specify button on the base model # product page
- To build a manual product code on this datasheet choose from the options listed below in blue font and add the suffix to the base model #

#### GENERAL

Series: Astros  
 Partner: Milan  
 Division: Design  
 Installation: Suspension  
 Product Type: Pendant  
 Mounting Location: Ceiling

#### PHYSICAL

Shape: Oval  
 Height (mm): 460  
 Height (in): 18 1/8  
 Max. Overall Height (mm): 3000  
 Max. Overall Height (in): 118 1/8  
 Weight (kg): 14.6  
 Weight (lbs): 32.199  
 Diffuser: Glass - Opal  
 Fixture Finish: MBQ  
 Fixture Material: Glass / Metal  
 Primary Material: Glass  
 Cable Details: 2540mm/100" Cable

#### ELECTRICAL

Number of Lamps: 10  
 Lamp Type: LED Retrofit  
 Bulb Included: Bulb Not Included  
 Total Output Wattage (W): 48  
 Max. Wattage Per Lamp (W): 4.8  
 Lamp Base: G9  
 Input Voltage (V): 120

#### LED

#### OPTICAL

#### RATINGS AND CERTIFICATIONS

Certified By: CSA Certified to UL and CSA Standards  
 IP rating: IP20

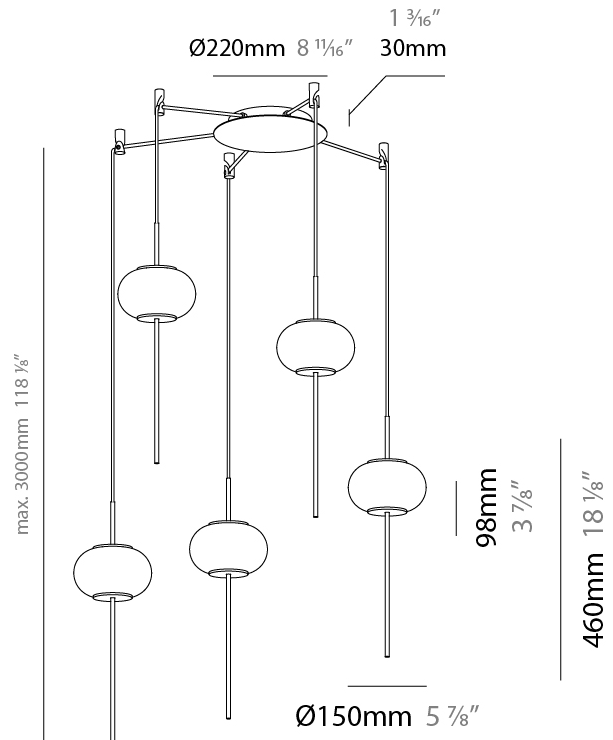

PROJECT	_____
TYPE	_____
SPECIFIER	_____
QUANTITY	_____
DATE	_____

## ASTROS SUSPENSION

### D91225

base number

- To build a product code in our configurator select the specify button on the base model # product page
- To build a manual product code on this datasheet choose from the options listed below in blue font and add the suffix to the base model #

#### GENERAL

Series: Astros  
 Partner: Milan  
 Division: Design  
 Installation: Suspension  
 Product Type: Pendant  
 Mounting Location: Ceiling

#### PHYSICAL

Shape: Oval  
 Height (mm): 460  
 Height (in): 18 1/8  
 Max. Overall Height (mm): 3000  
 Max. Overall Height (in): 118 1/8  
 Weight (kg): 15.7  
 Weight (lbs): 34.619  
 Diffuser: Glass - Opal  
 Fixture Finish: MBQ  
 Fixture Material: Glass / Metal  
 Primary Material: Glass  
 Cable Details: 2540mm/100" Cable

#### ELECTRICAL

Number of Lamps: 6  
 Lamp Type: LED Retrofit  
 Bulb Included: Bulb Not Included  
 Total Output Wattage (W): 57.2  
 Max. Wattage Per Lamp (W): 4.8  
 Lamp Base: G9  
 Input Voltage (V): 120Vac Direct Line

#### LED

#### OPTICAL

#### RATINGS AND CERTIFICATIONS

Certified By: CSA Certified to UL and CSA Standards  
 IP rating: IP20

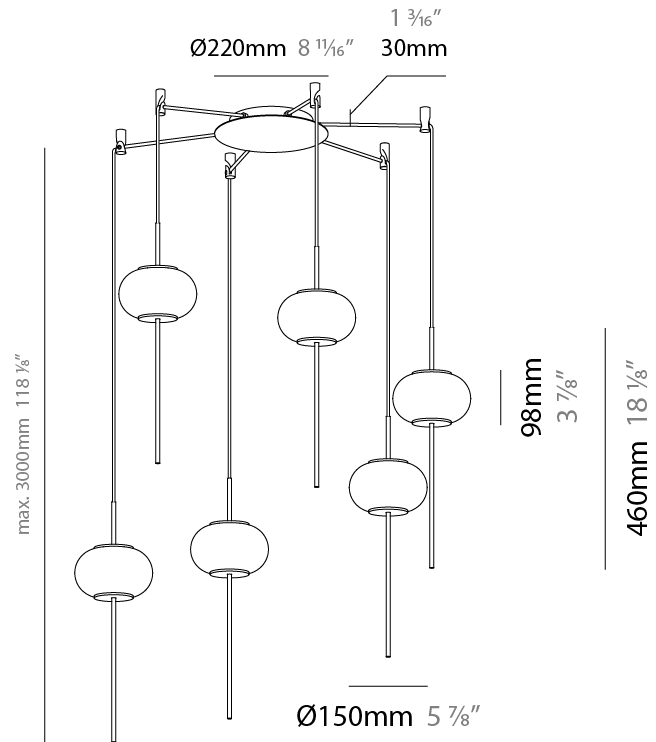

PROJECT	
TYPE	
SPECIFIER	
QUANTITY	
DATE	

## ASTROS SUSPENSION

### D91231

base number

- To build a product code in our configurator select the specify button on the base model # product page
- To build a manual product code on this datasheet choose from the options listed below in blue font and add the suffix to the base model #

#### GENERAL

Series: Astros  
 Partner: Milan  
 Division: Design  
 Installation: Suspension  
 Product Type: Pendant  
 Mounting Location: Ceiling

#### PHYSICAL

Shape: Oval  
 Diameter (mm): 150  
 Diameter (in): 5 7/8  
 Height (mm): 460  
 Height (in): 18 1/8  
 Max. Overall Height (mm): 3000  
 Max. Overall Height (in): 118 1/8  
 Diffuser: Glass - Opal  
 Fixture Finish: MBQ  
 Fixture Material: Glass / Metal  
 Primary Material: Glass  
 Cable Details: 2540mm/100" Cable

#### ELECTRICAL

Number of Lamps: 2  
 Lamp Type: LED Retrofit  
 Bulb Included: Bulb Not Included  
 Max. Wattage Per Lamp (W): 4.8  
 Lamp Base: G9  
 Input Voltage (V): 120

#### LED

#### OPTICAL

#### RATINGS AND CERTIFICATIONS

Certified By: Certified for North American Standards  
 IP rating: IP20

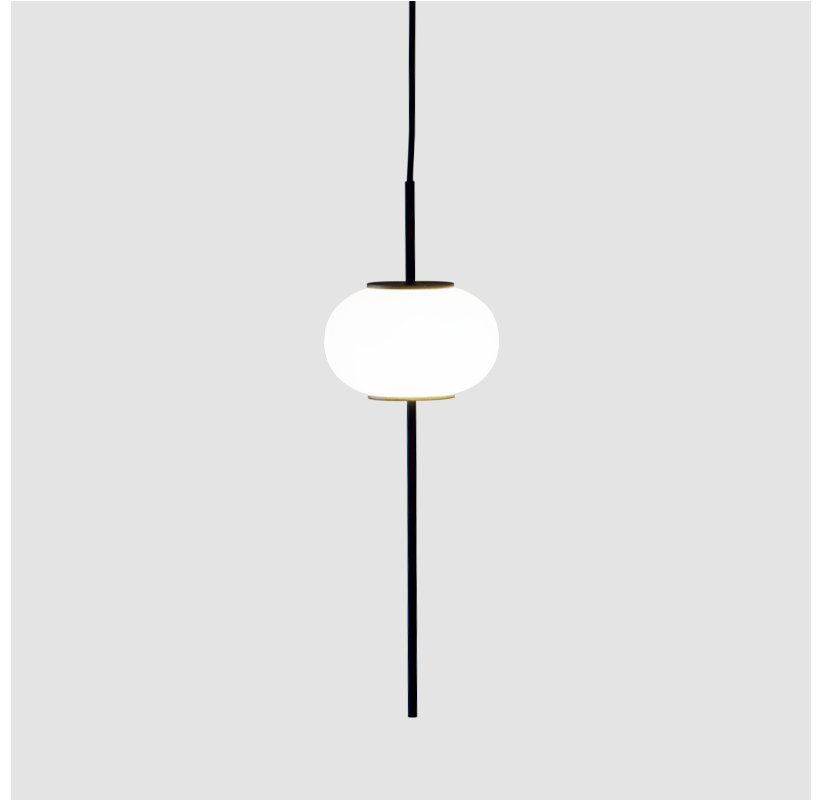

PROJECT

TYPE

SPECIFIER

QUANTITY

DATE

## ASTROS SUSPENSION

### D9ASTRO-MOD-SYS

base number

1. To build a product code in our configurator select the specify button on the base model # product page
2. To build a manual product code on this datasheet choose from the options listed below in blue font and add the suffix to the base model #

#### GENERAL

Series: Astros  
Partner: Milan  
Division: Design  
Installation: Suspension  
Product Type: Clusters  
Mounting Location: Ceiling

#### PHYSICAL

#### ELECTRICAL

#### LED

#### OPTICAL

#### RATINGS AND CERTIFICATIONS

Certified By: CSA Certified to UL and CSA Standards  
IP rating: IP55



PROJECT

TYPE

SPECIFIER

QUANTITY

DATE

#### Fixture Finish

Matte Black Lacquer - MBQ

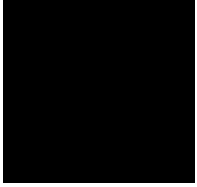

**Digital:** Not all screens are calibrated the same, and therefore, colors will appear differently between screens.

**Physical:** When texture is involved, there will be variations in color, character and tone within a product series and between product families.



### LEGEND

 floor-mounted	 pivotable	 special LED (upon request) RGB, RGBW, tunable, gold+, meat+, art+, fashion+
 wall and ceiling: recessed and surface mounted	 rotating	 warm dim / natural dimming LED
 ceiling-mounted and wall-mounted	 illuminate tilted	 rechargeable battery powered
 wall-mounted	 color of suspension cable	 fixture with natural vivid LED (upon request)
 omni-directional light distribution	 length of suspension cable	 color rendering index
 direct light distribution	 reflector degree selection	 color temperature
 direct/indirect light distribution	 super spot	 lumen (luminous flux)
 indirect light distribution	 lens	 efficacy (lumens per watt)
 asymmetric light distribution	 lens pack	 Unified Glare Rating (UGR) range from 5-40
 aura light distribution	 shine ring	 marine grade (AISI 316 stainless steel)
 round wall or ceiling cut-out	 integrated shine ring with diffuser	 walk on
 square wall or ceiling cut-out	 free individual colors 01-29	 drive on
 the supplied jig specifies the cutout dimensions	 individual colors: 00 (free of charge), 01-25 (extra charge)	 Dark Sky Compliance
 minimum distance (meters) lamp - object	 luminaire part to be colored (F1)	 Americans with Disabilities Act (less than 4" off the wall located between 27"-84" from floor)
 recessed depth	 luminaire part to be colored (F2)	 lamp protected against explosion
 ceiling thickness in mm	 luminaire part to be colored (F3)	 blown glass using traditional methods by master glass blower
 ceiling thickness selection	 luminaire part to be colored (F4)	 acoustic material
 dimmable DP (phase), DV (0-10V), DD (dali), DS (step-dim)	 luminaire part to be colored (F5)	 protection class I, protection insulation
 included or excluded LED driver/transformer/control gear	 color of 3-circuit adaptor	 protection class II, protection insulation
 separately switchable	 indirect diffuser	 ETL Certified to UL and CSA Standards
 sensor	 direct diffuser	 UL Certified to UL and CSA Standards
 remote control	 ball-proof (upon request)	 CSA Certified to UL and CSA Standards
 available upon request	 accessory	 Certified for North American Standards

### IP RATING

 IP20	protected against ingress of solid bodies greater than 12.5mm (finger)
 IP33	protected against ingress of solid bodies greater than 2.5mm protected against sprays of water up to 60 degrees from the vertical (rain)
 IP40	protected against ingress of solid bodies greater than 1mm (wire) no protection against the ingress of moisture
 IP43	protected against ingress of solid bodies greater than 1mm (wire) protected against sprays of water up to 60 degrees from the vertical (rain)
 IP44	protected against ingress of solid bodies greater than 1mm (wire) protected against water splashed from all directions
 IP54	protected against limited ingress of dust (wet rooms/covered outdoor areas) protected against water splashed from all directions
 IP65	protected against ingress of dust protected against jets of water
 IP66	protected against ingress of dust protected against powerful jets of water or heavy seas
 IP67	protected against ingress of dust protected against immersion of water between 15cm - 1m for 30 minutes
 IP68	protected against ingress of dust protected against immersion of water under pressure for long periods

### IK RATING

 IK01	protected against 0.14 joules impact (equivalent to 0.25kg mass dropped from 56mm above the surface)
 IK02	protected against 0.2 joules impact (equivalent to 0.25kg mass dropped from 80mm above the surface)
 IK03	protected against 0.35 joules impact (equivalent to 0.25kg mass dropped from 140mm above the surface)
 IK04	protected against 0.5 joules impact (equivalent to 0.25kg mass dropped from 200mm above the surface)
 IK05	protected against 0.7 joules impact (equivalent to 0.25kg mass dropped from 280mm above the surface)
 IK06	protected against 1 joules impact (equivalent to 0.25kg mass dropped from 400mm above the surface)
 IK07	protected against 2 joules impact (equivalent to 0.5kg mass dropped from 400mm above the surface)
 IK08	protected against 5 joules impact (equivalent to 1.7kg mass dropped from 300mm above the surface)
 IK09	protected against 10 joules impact (equivalent to 5.0kg mass dropped from 200mm above the surface)
 IK10	protected against 20 joules impact (equivalent to 5.0kg mass dropped from 400mm above the surface)