

PROJECT	_____
TYPE	_____
SPECIFIER	_____
QUANTITY	_____
DATE	_____

ATMOSS SUSPENSION

A3001151-

base number	Color Temperature	Finishes (Diamond)	Finishes (Triangle)	Acoustic Options	Cable Length	Diffuser Options
-------------	-------------------	--------------------	---------------------	------------------	--------------	------------------

- To build a product code in our configurator select the specify button on the base model # product page
- To build a manual product code on this datasheet choose from the options listed below in blue font and add the suffix to the base model #

GENERAL

Series: AtmoSS
 Partner: Prolicht
 Division: Architectural
 Installation: Suspension
 Product Type: Acoustic
 Mounting Location: Ceiling
 Light Distribution: Direct

PHYSICAL

Shape: Disc
 Diameter (mm): 738
 Diameter (in): 29 1/8
 Height (mm): 82
 Height (in): 3 1/4
 Max. Overall Height (mm): 2082
 Max. Overall Height (in): 81 15/16
 Weight (kg): 4

Diffuser: [Clear / Microprism / Clear Microprism](#)
 Fixture Finish: [SSR / BKV / CWI / CRY / HAB / UFT / ITA / RUA / FTG / MYG / LOD / PUS / FRO / FUP / KIA / POP / BLS / SPG / MEY / GOH / CHC / COM / ABZ / JAG / OBR / MOS / ROR](#)
 Holder Finish: [SSR / BKV / CWI / CRY / HAB / LAG / UFT / ITA / RUA / RUR / MIC / FTG / MYG / TWT / LOD / PUS / FRO / FUP / KIA / POP / BLS / SPG / MEY / GOH / GUM / CHC / COM / ABZ / JAG](#)
 Acoustic Finish: [SFW / CYW / SEE / SYN / MTS / PMB / TTN / CYB / STO / DPE / BES / SHB / ARE / ANE / VRD / CRF](#)
 Fixture Material: [Acoustic / Aluminum / PMMA](#)
 Primary Material: [Acoustic](#)
 Cable Details: [2000mm/78 3/4" or 6000mm/236 1/4" Cable, - Transparent](#)

ELECTRICAL

Lamp Type: LED
 Input Wattage (W): 26.4
 Total Output Wattage (W): 23.6
 Dimming: [Non-dimming / DALI Dimming / MATTER Dimming](#)
 Driver Included: Yes
 Driver Location: [Integrated](#)
 Driver Type: [Constant Current - Universal](#)
 Driver Class: [Class 2](#)
 Input Voltage (V): 120
 Constant Current (MA): 700mA
 Upon Request: [0-10V Dimming / Phase Dimming](#)

LED

Color Temperature (°K): [2700 / 3000 / 3500 / 4000](#)
 Max. Delivered Lumen (lm): [Max 4071](#)
 Nominal Lumen (lm): [Max 4704](#)
 CRI: [>90 CRI](#)
 Lamp Life (hrs): [50000](#)

OPTICAL

RATINGS AND CERTIFICATIONS

Certified By: [Certified for North American Standards](#)
 IP rating: [IP20](#)

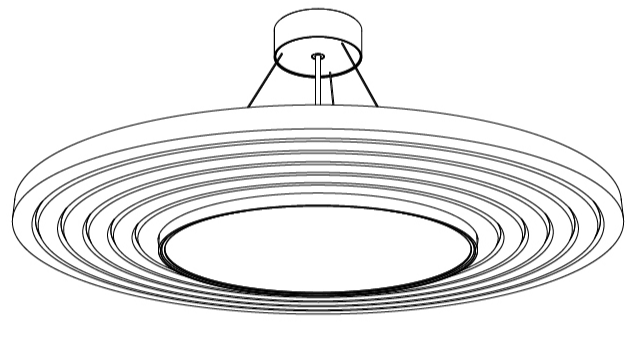

Ø738mm 29 1/8"



A3001151-

PROJECT	_____
TYPE	_____
SPECIFIER	_____
QUANTITY	_____
DATE	_____



A

PROJECT	_____
TYPE	_____
SPECIFIER	_____
QUANTITY	_____
DATE	_____

ATMOSS SUSPENSION

A3001153-

base number	Color Temperature	Finishes (Diamond)	Finishes (Triangle)	Acoustic Options	Cable Length	Diffuser Options
-------------	-------------------	--------------------	---------------------	------------------	--------------	------------------

- To build a product code in our configurator select the specify button on the base model # product page
- To build a manual product code on this datasheet choose from the options listed below in blue font and add the suffix to the base model #

GENERAL

Series: Atmoss
 Partner: Prolicht
 Division: Architectural
 Installation: Suspension
 Product Type: Acoustic
 Mounting Location: Ceiling
 Light Distribution: Direct

PHYSICAL

Shape: Disc
 Diameter (mm): 1150
 Diameter (in): 45 1/4
 Height (mm): 82
 Height (in): 3 1/4
 Max. Overall Height (mm): 2082
 Max. Overall Height (in): 81 15/16
 Weight (kg): 4

Diffuser: [Clear / Microprism / Clear Microprism](#)
 Fixture Finish: [SSR / BKV / CWI / CRY / HAB / UFT / ITA / RUA / FTG / MYG / LOD / PUS / FRO / FUP / KIA / POP / BLS / SPG / MEY / GOH / CHC / COM / ABZ / JAG / OBR / MOS / ROR](#)
 Holder Finish: [SSR / BKV / CWI / CRY / HAB / LAG / UFT / ITA / RUA / RUR / MIC / FTG / MYG / TWT / LOD / PUS / FRO / FUP / KIA / POP / BLS / SPG / MEY / GOH / GUM / CHC / COM / ABZ / JAG](#)
 Acoustic Finish: [SFW / CYW / SEE / SYN / MTS / PMB / TTN / CYB / STO / DPE / BES / SHB / ARE / ANE / VRD / CRF](#)
 Fixture Material: [Acoustic / Aluminum / PMMA](#)
 Primary Material: [Acoustic](#)
 Cable Details: [2000mm/78 3/4" or 6000mm/236 1/4" Cable, - Transparent](#)

ELECTRICAL

Lamp Type: LED
 Input Wattage (W): 26.4
 Total Output Wattage (W): 23.6
 Dimming: [Non-dimming / DALI Dimming / MATTER Dimming](#)
 Driver Included: Yes
 Driver Location: [Integrated](#)
 Driver Type: [Constant Current - Universal](#)
 Driver Class: [Class 2](#)
 Input Voltage (V): 120
 Constant Current (MA): 700mA
 Upon Request: [0-10V Dimming / Phase Dimming](#)

LED

Color Temperature (°K): [2700 / 3000 / 3500 / 4000](#)
 Max. Delivered Lumen (lm): [Max 4071](#)
 Nominal Lumen (lm): [Max 4704](#)
 CRI: [>90 CRI](#)
 Lamp Life (hrs): [50000](#)

OPTICAL

RATINGS AND CERTIFICATIONS

Certified By: [Certified for North American Standards](#)
 IP rating: [IP20](#)

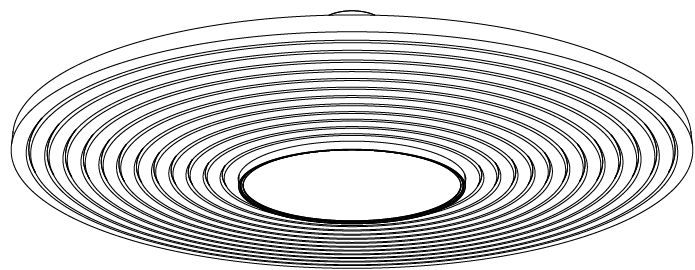

Ø1150mm 45 1/4"



A3001153-

PROJECT	_____
TYPE	_____
SPECIFIER	_____
QUANTITY	_____
DATE	_____

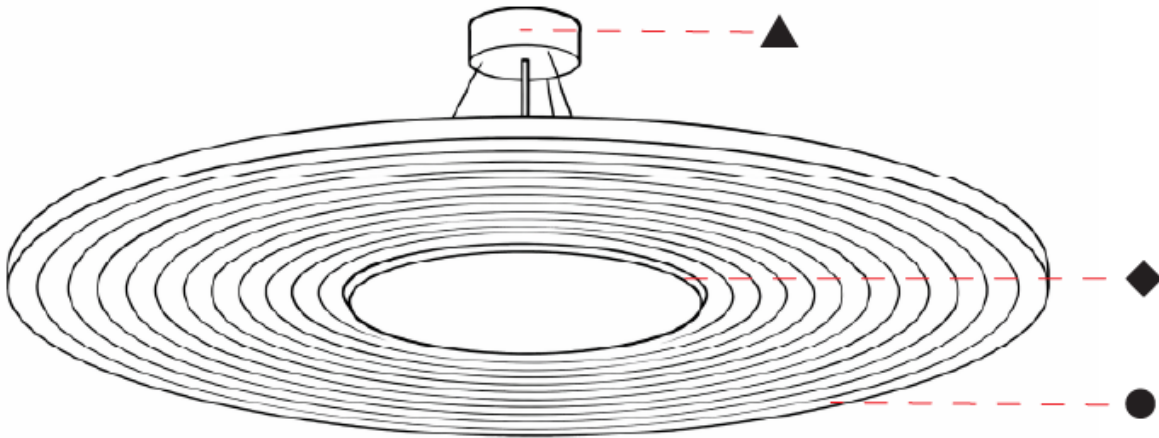

A

PROJECT _____
 TYPE _____
 SPECIFIER _____
 QUANTITY _____
 DATE _____

Fixture Finish



Holder Finish



Digital: Not all screens are calibrated the same, and therefore, colors will appear differently between screens.
Physical: When texture is involved, there will be variations in color, character and tone within a product series and between product families.

Champagne Cream, Copper Mine, Ancient Bronze + Jazz Gold: These finishes have slight fading from specific powder coating production. Each luminaire will slight



PROJECT _____

TYPE _____

SPECIFIER _____

QUANTITY _____

DATE _____

Acoustic Finish

Snowfall White - 44 (SFW)



Creamy White - 97 (CYW)



Stone Echo - 83 (SEE)



Smoky Iron - 50 (SYN)



Midnight Stone - 51 (MTS)



Phantom Black - 71 (PMB)



Twilight Navy - 69 (TTN)



Cloudy Blue - 73 (CYB)



Soft Olive - 82 (STO)



Deep Evergreen - 91 (DPE)



Bronze Shadow - 87 (BES)



Savannah Brown - 42 (SHB)



Amber Earth - 55 (ARE)



Autumn Ember - 90 (ANE)



Vintage Red - 99 (VRD)



Coral Reef - 98 (CRF)



LEGEND

	floor-mounted		pivotable		special LED (upon request) RGB, RGBW, tunable, gold+, meat+, art+, fashion+
	wall and ceiling: recessed and surface mounted		rotating		warm dim / natural dimming LED
	ceiling-mounted and wall-mounted		illuminate tilted		rechargeable battery powered
	wall-mounted		color of suspension cable		fixture with natural vivid LED (upon request)
	omni-directional light distribution		length of suspension cable		color rendering index
	direct light distribution		reflector degree selection		color temperature
	direct/indirect light distribution		super spot		lumen (luminous flux)
	indirect light distribution		lens		efficacy (lumens per watt)
	asymmetric light distribution		lens pack		Unified Glare Rating (UGR) range from 5-40
	aura light distribution		shine ring		marine grade (AISI 316 stainless steel)
	round wall or ceiling cut-out		integrated shine ring with diffuser		walk on
	square wall or ceiling cut-out		free individual colors 01-29		drive on
	the supplied jig specifies the cutout dimensions		individual colors: 00 (free of charge), 01-25 (extra charge)		Dark Sky Compliance
	minimum distance (meters) lamp - object		luminaire part to be colored (F1)		Americans with Disabilities Act (less than 4" off the wall located between 27"-84" from floor)
	recessed depth		luminaire part to be colored (F2)		lamp protected against explosion
	ceiling thickness in mm		luminaire part to be colored (F3)		blown glass using traditional methods by master glass blower
	ceiling thickness selection		luminaire part to be colored (F4)		acoustic material
	dimmable DP (phase), DV (0-10V), DD (dali), DS (step-dim)		luminaire part to be colored (F5)		protection class I, protection insulation
	included or excluded LED driver/transformer/control gear		color of 3-circuit adaptor		protection class II, protection insulation
	separately switchable		indirect diffuser		ETL Certified to UL and CSA Standards
	sensor		direct diffuser		UL Certified to UL and CSA Standards
	remote control		ball-proof (upon request)		CSA Certified to UL and CSA Standards
	available upon request		accessory		Certified for North American Standards

IP RATING

	protected against ingress of solid bodies greater than 12.5mm (finger)
	protected against ingress of solid bodies greater than 2.5mm protected against sprays of water up to 60 degrees from the vertical (rain)
	protected against ingress of solid bodies greater than 1mm (wire) no protection against the ingress of moisture
	protected against ingress of solid bodies greater than 1mm (wire) protected against sprays of water up to 60 degrees from the vertical (rain)
	protected against ingress of solid bodies greater than 1mm (wire) protected against water splashed from all directions
	protected against limited ingress of dust (wet rooms/covered outdoor areas) protected against water splashed from all directions
	protected against ingress of dust protected against jets of water
	protected against ingress of dust protected against powerful jets of water or heavy seas
	protected against ingress of dust protected against immersion of water between 15cm - 1m for 30 minutes
	protected against ingress of dust protected against immersion of water under pressure for long periods

IK RATING

	protected against 0.14 joules impact (equivalent to 0.25kg mass dropped from 56mm above the surface)
	protected against 0.2 joules impact (equivalent to 0.25kg mass dropped from 80mm above the surface)
	protected against 0.35 joules impact (equivalent to 0.25kg mass dropped from 140mm above the surface)
	protected against 0.5 joules impact (equivalent to 0.25kg mass dropped from 200mm above the surface)
	protected against 0.7 joules impact (equivalent to 0.25kg mass dropped from 280mm above the surface)
	protected against 1 joules impact (equivalent to 0.25kg mass dropped from 400mm above the surface)
	protected against 2 joules impact (equivalent to 0.5kg mass dropped from 400mm above the surface)
	protected against 5 joules impact (equivalent to 1.7kg mass dropped from 300mm above the surface)
	protected against 10 joules impact (equivalent to 5.0kg mass dropped from 200mm above the surface)
	protected against 20 joules impact (equivalent to 5.0kg mass dropped from 400mm above the surface)