

BALTI 220 SURFACE

E5W002-

base number Finish
Options

- To build a product code in our configurator select the specify button on the base model # product page
- To build a manual product code on this datasheet choose from the options listed below in blue font and add the suffix to the base model #

GENERAL

Series: Balti _____
Subseries: Balti 220 _____
Brand: Ivela _____
Division: Exterior _____
Mounting Type: Surface _____
Mounting Location: Wall _____
Subcategory: Wall Effect _____

PHYSICAL

Shape: Rectangle _____
Length (mm): 225 _____
Length (in): 8 ⁷/₈ _____
Width (mm): 166 _____
Width (in): 6 ⁹/₁₆ _____
Height (mm): 225 _____
Height (in): 8 ⁷/₈ _____
Extension (mm): 56 _____
Extension (in): 2 ³/₁₆ _____
Light Distribution: Direct _____
Weight (kg): 1.9 _____
Weight (lbs): 4.19 _____
Diffuser: Tempered Glass _____
Fixture Finish: MWH / SIL _____
Fixture Material: Aluminum Die Cast _____

ELECTRICAL

Lamp Type: LED _____
Total Output Wattage (W): 37 _____
Dimming: Non-Dimmable _____
Driver Included: Yes _____
Driver Location: Integrated _____
Driver Type: Constant Current - 120Vac _____
Driver Class: Class 2 _____
Input Voltage (V): 120 - 277 _____
Constant Current (mA): 1050 _____
Upon Request: Remote: 0-10Vdc dimming / Phase dimming 120Vac only / Non-dimming 120/277Vac _____

LED

Color Temperature (°K): 3000 _____
Max. Delivered Lumen (lm): 4005 _____
CRI: >85 CRI _____
Lamp Life (hrs): 50000 _____

OPTICAL

Reflector°: 100 _____

RATINGS AND CERTIFICATIONS

Certified By: Certified for North American Standards _____
IP Rating: IP66 _____
IK Rating: IK09 _____
Upon Request: Dark Sky Certification _____

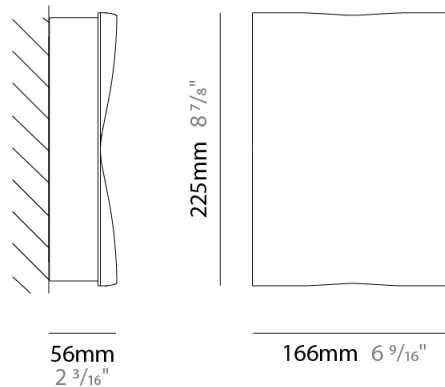

BALTI 220 SURFACE

E5W002-

PROJECT _____

TYPE _____

SPECIFIER _____

QUANTITY _____

DATE _____



E

PROJECT
TYPE
SPECIFIER
QUANTITY
DATE

BALTI 150 SURFACE

E5W005- -
 base number Color Finish
 Temperature Options

- To build a product code in our configurator select the specify button on the base model # product page
- To build a manual product code on this datasheet choose from the options listed below in blue font and add the suffix to the base model #

GENERAL

Series: Balti
 Subseries: Balti 150
 Brand: Ivela
 Division: Exterior
 Mounting Type: Surface
 Mounting Location: Wall
 Subcategory: Wall Effect

PHYSICAL

Shape: Rectangle
 Length (mm): 158
 Length (in): 6 1/4
 Width (mm): 163
 Width (in): 6 7/16
 Extension (mm): 48
 Extension (in): 1 7/8
 Light Distribution: Direct
 Weight (kg): 1.1
 Weight (lbs): 2.42
 Diffuser: Tempered Glass
 Fixture Finish: MWH / SIL
 Fixture Material: Aluminum Die Cast

ELECTRICAL

Lamp Type: LED
 Total Output Wattage (W): 26
 Dimming: Non-Dimming / Phase Dimming (120vac Only)
 Driver Included: Yes
 Driver Location: Integrated
 Driver Type: Constant Current - Universal
 Driver Class: Class 2
 Input Voltage (V): 120 - 277
 Constant Current (MA): 700
 Upon Request: (See components [IP65 or higher enclosure to be supplied by others]) Remote: 0-10Vdc dimming

LED

Number of LEDs: 1
 Color Temperature (°K): 3000 / 3500
 Max. Delivered Lumen (lm): 2551
 CRI: >85 CRI
 Lamp Life (hrs): 50000

OPTICAL

Reflector°: 110
 Beam Angle: Asymmetric - wide
 Adjustability: Fixed

RATINGS AND CERTIFICATIONS

Certified By: Certified for North American Standards
 IP rating: IP66
 Upon Request: Dark Sky Certification

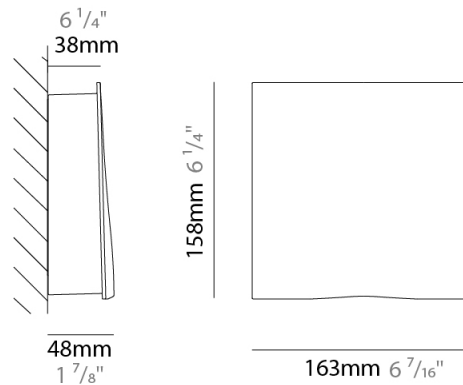

BALTI 150 SURFACE

E5W005-

PROJECT _____

TYPE _____

SPECIFIER _____

QUANTITY _____

DATE _____

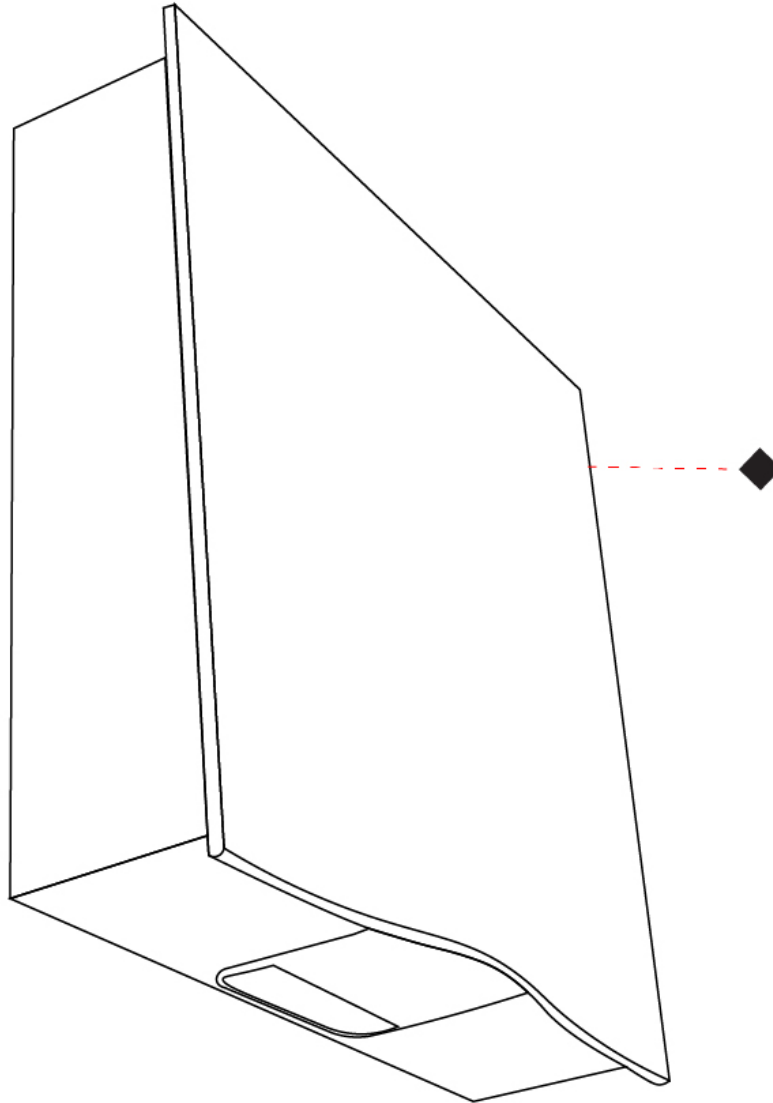

E

BALTI 150 SURFACE

E5W006-

base number Color Finish
 Temperature Options

PROJECT
TYPE
SPECIFIER
QUANTITY
DATE

- To build a product code in our configurator select the specify button on the base model # product page
- To build a manual product code on this datasheet choose from the options listed below in blue font and add the suffix to the base model #

GENERAL

Series: Balti
 Subseries: Balti 150
 Brand: Ivela
 Division: Exterior
 Mounting Type: Surface
 Mounting Location: Wall
 Subcategory: Wall Effect

PHYSICAL

Shape: Rectangle
 Length (mm): 158
 Length (in): 6 1/4
 Width (mm): 163
 Width (in): 6 7/16
 Height (mm): 48
 Height (in): 1 7/8
 Extension (mm): 48
 Extension (in): 1 7/8
 Light Distribution: Direct
 Weight (kg): 1.1
 Weight (lbs): 2.42
 Diffuser: Tempered Glass
 Fixture Finish: MWH / SIL
 Fixture Material: Aluminum Die Cast

ELECTRICAL

Lamp Type: LED
 Total Output Wattage (W): 12
 Dimming: Non-Dimming / Phase Dimming (120vac Only)
 Driver Included: Yes
 Driver Location: Integrated
 Driver Type: Constant Current - Universal
 Driver Class: Class 2
 Input Voltage (V): 120 - 277
 Constant Current (MA): 350
 Upon Request: (See components [IP65 or higher enclosure to be supplied by others]) Remote: 0-10Vdc dimming

LED

Number of LEDs: 1
 Color Temperature (°K): 3000 / 3500
 Max. Delivered Lumen (lm): 1348
 CRI: >85 CRI
 Lamp Life (hrs): 50000

OPTICAL

Reflector: 110
 Beam Angle: Asymmetric - wide

RATINGS AND CERTIFICATIONS

Certified By: Certified for North American Standards
 IP rating: IP66
 Upon Request: Dark Sky Certification

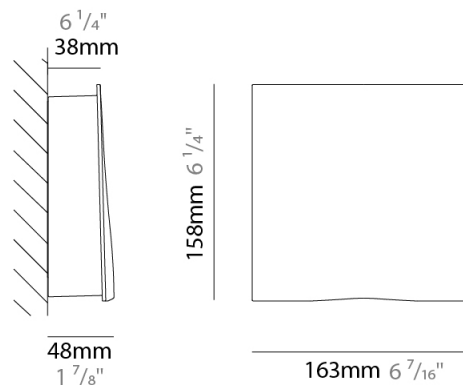

BALTI 150 SURFACE

E5W006-

PROJECT

TYPE

SPECIFIER

QUANTITY

DATE

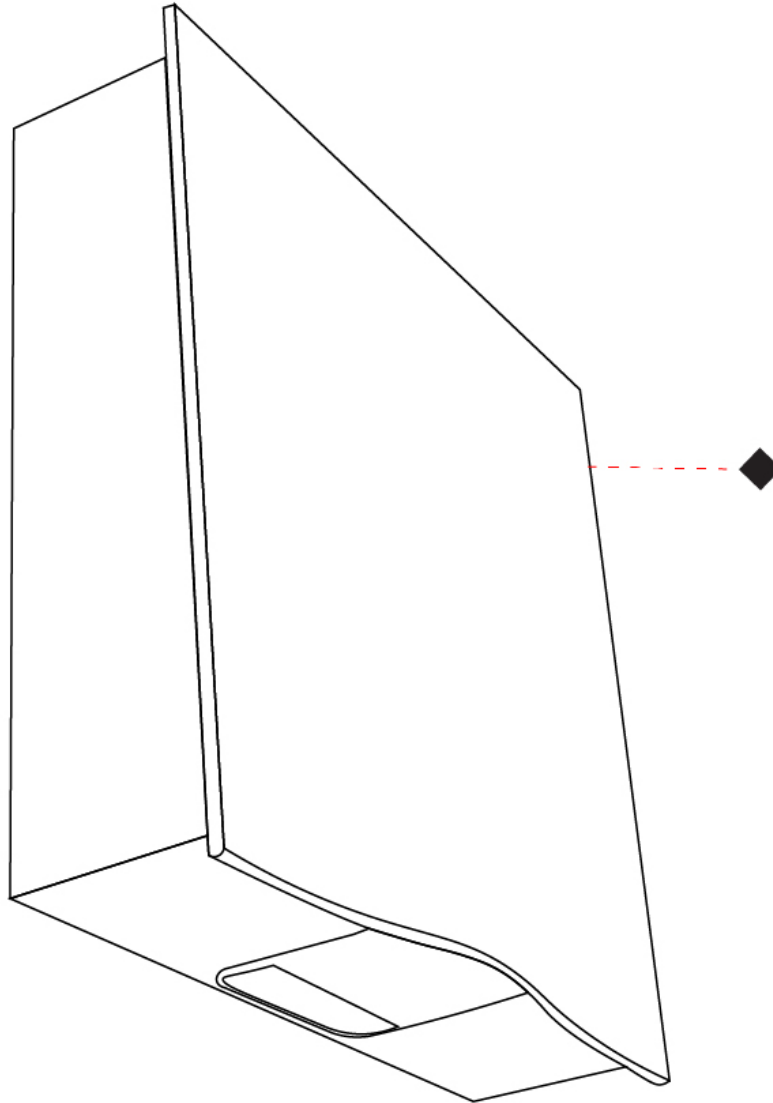

E

BALTI 80 SURFACE

E5W007-

base number Color Finish
 Temperature Options

PROJECT
TYPE
SPECIFIER
QUANTITY
DATE

- To build a product code in our configurator select the specify button on the base model # product page
- To build a manual product code on this datasheet choose from the options listed below in blue font and add the suffix to the base model #

GENERAL

Series: Balti
 Subseries: Balti 80
 Brand: Ivela
 Division: Exterior
 Mounting Type: Surface
 Mounting Location: Wall
 Subcategory: Wall Effect

PHYSICAL

Shape: Rectangle
 Length (mm): 153
 Length (in): 6
 Width (mm): 83
 Width (in): 3 1/4
 Depth (mm): 46
 Depth (in): 1 13/16
 Light Distribution: Direct
 Weight (kg): 0.5
 Weight (lbs): 1.10
 Load Resistance (kg): 0.5
 Load Resistance (lbs): 1.1
 Screws: A4 stainless steel
 Diffuser: Tempered Glass
 Gasket: Silicone
 Fixture Finish: MWH / SIL
 Fixture Material: Aluminum Die Cast

ELECTRICAL

Lamp Type: LED
 Total Output Wattage (W): 6.5
 Dimming: Non-Dimmable
 Driver Included: Yes
 Driver Location: Integrated
 Driver Type: Constant Current - 120Vac
 Driver Class: Class 2
 Input Voltage (V): 120 - 277
 Constant Current (MA): 350
 Upon Request: (See components [IP65 or higher enclosure to be supplied by others]) Remote: 0-10Vdc dimming / Phase dimming 120Vac only / Non-dimming 120/277Vac

LED

Number of LEDs: 1
 Color Temperature (°K): 3000 / 3500
 Max. Delivered Lumen (lm): 646
 CRI: >85 CRI
 Efficiency (%): 76
 Lamp Life (hrs): 50000

OPTICAL

Reflector: 110
 Beam Angle: Asymmetrical - wide

RATINGS AND CERTIFICATIONS

Certified By: Certified for North American Standards
 Code Compliance: Dark Sky
 IP rating: IP65
 IK Rating: IK09

Upon Request: Dark Sky Certification
 Zaneen Group Inc. © 2024, 1-800-388-3382, F 416-247-9319, www.zaneen.com

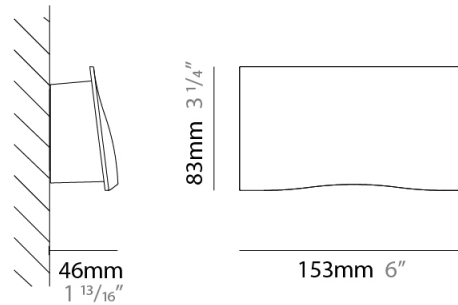

E5W007-

PROJECT	_____
TYPE	_____
SPECIFIER	_____
QUANTITY	_____
DATE	_____

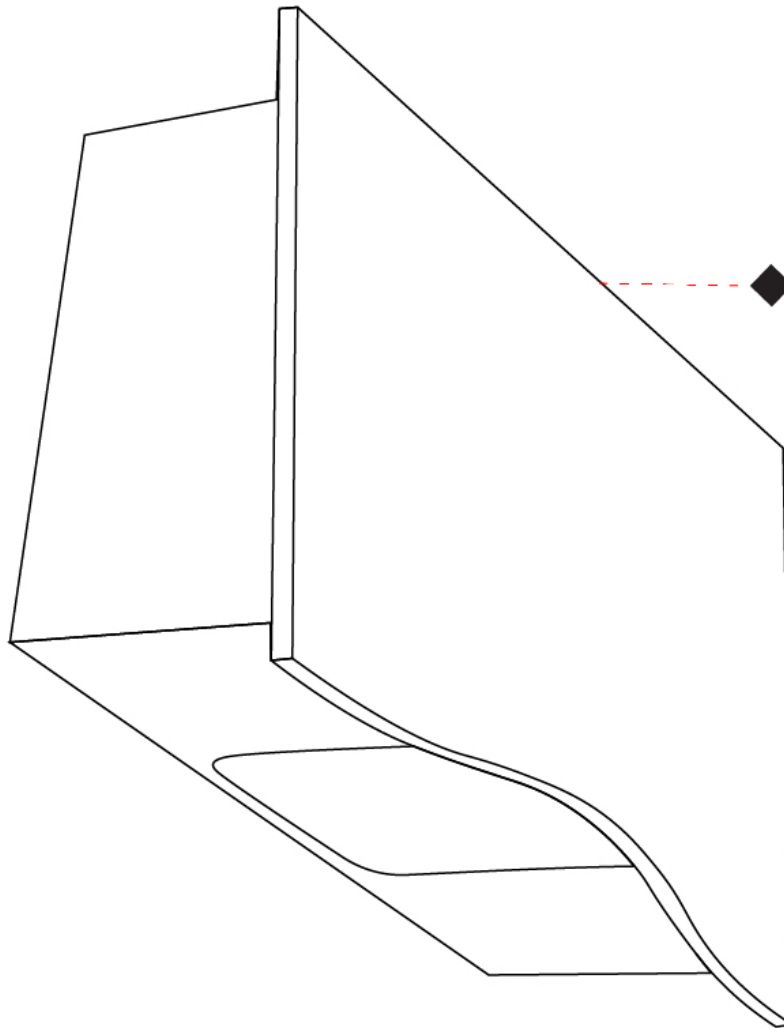

E

BALTI COLOR FINISH CHART

PROJECT _____

TYPE _____

SPECIFIER _____

QUANTITY _____

DATE _____

Fixture Finish

Matte White - MWH



Silver - SIL

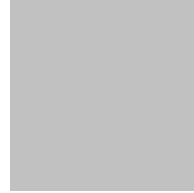





































































Digital: Not all screens are calibrated the same, and therefore, colors will appear differently between screens.

Physical: When texture is involved, there will be variations in color, character and tone within a product series and between product families.



LEGEND

	floor-mounted		pivotal		special LED (upon request) RGB, RGBW, tunable, gold+, meat+, art+, fashion+
	wall and ceiling: recessed and surface mounted		rotating		warm dim / natural dimming LED
	ceiling-mounted and wall-mounted		illuminate tilted		rechargeable battery powered
	wall-mounted		color of suspension cable		fixture with natural vivid LED (upon request)
	omni-directional light distribution		length of suspension cable		color rendering index
	direct light distribution		reflector degree selection		color temperature
	direct/indirect light distribution		super spot		lumen (luminous flux)
	indirect light distribution		lens		efficacy (lumens per watt)
	asymmetric light distribution		lens pack		Unified Glare Rating (UGR) range from 5-40
	aura light distribution		shine ring		marine grade (AISI 316 stainless steel)
	round wall or ceiling cut-out		integrated shine ring with diffuser		walk on
	square wall or ceiling cut-out		free individual colors 01-29		drive on
	the supplied jig specifies the cutout dimensions		individual colors: 00 (free of charge), 01-25 (extra charge)		Dark Sky Compliance
	minimum distance (meters) lamp - object		luminaire part to be colored (F1)		Americans with Disabilities Act (less than 4" off the wall located between 27"-84" from floor)
	recessed depth		luminaire part to be colored (F2)		lamp protected against explosion
	ceiling thickness in mm		luminaire part to be colored (F3)		blown glass using traditional methods by master glass blower
	ceiling thickness selection		luminaire part to be colored (F4)		acoustic material
	dimnable DP (phase), DV (0-10V), DD (dali), DS (step-dim)		luminaire part to be colored (F5)		protection class I, protection insulation
	included or excluded LED driver/transformer/control gear		color of 3-circuit adaptor		protection class II, protection insulation
	separately switchable		indirect diffuser		ETL Certified to UL and CSA Standards
	sensor		direct diffuser		UL Certified to UL and CSA Standards
	remote control		ball-proof (upon request)		CSA Certified to UL and CSA Standards
	available upon request		accessory		Certified for North American Standards

IP RATING

	protected against ingress of solid bodies greater than 12.5mm (finger)
	protected against ingress of solid bodies greater than 2.5mm protected against sprays of water up to 60 degrees from the vertical (rain)
	protected against ingress of solid bodies greater than 1mm (wire) no protection against the ingress of moisture
	protected against ingress of solid bodies greater than 1mm (wire) protected against sprays of water up to 60 degrees from the vertical (rain)
	protected against ingress of solid bodies greater than 1mm (wire) protected against water splashed from all directions
	protected against limited ingress of dust (wet rooms/covered outdoor areas) protected against water splashed from all directions
	protected against ingress of dust protected against jets of water
	protected against ingress of dust protected against powerful jets of water or heavy seas
	protected against ingress of dust protected against immersion of water between 15cm - 1m for 30 minutes
	protected against ingress of dust protected against immersion of water under pressure for long periods

IK RATING

	protected against 0.14 joules impact (equivalent to 0.25kg mass dropped from 56mm above the surface)
	protected against 0.2 joules impact (equivalent to 0.25kg mass dropped from 80mm above the surface)
	protected against 0.35 joules impact (equivalent to 0.25kg mass dropped from 140mm above the surface)
	protected against 0.5 joules impact (equivalent to 0.25kg mass dropped from 200mm above the surface)
	protected against 0.7 joules impact (equivalent to 0.25kg mass dropped from 280mm above the surface)
	protected against 1 joules impact (equivalent to 0.25kg mass dropped from 400mm above the surface)
	protected against 2 joules impact (equivalent to 0.5kg mass dropped from 400mm above the surface)
	protected against 5 joules impact (equivalent to 1.7kg mass dropped from 300mm above the surface)
	protected against 10 joules impact (equivalent to 5.0kg mass dropped from 200mm above the surface)
	protected against 20 joules impact (equivalent to 5.0kg mass dropped from 400mm above the surface)