

PROJECT	_____
TYPE	_____
SPECIFIER	_____
QUANTITY	_____
DATE	_____

BANYO SUSPENSION

D111000-

base number Finish
Options

- To build a product code in our configurator select the specify button on the base model # product page
- To build a manual product code on this datasheet choose from the options listed below in blue font and add the suffix to the base model #

GENERAL

Series: Banyo _____
 Partner: Ole _____
 Division: Design _____
 Installation: Suspension _____
 Product Type: Pendant _____
 Mounting Location: Ceiling _____
 Light Distribution: Direct _____

PHYSICAL

Shape: Dome _____
 Diameter (mm): 300 _____
 Diameter (in): 11 ¹³/₁₆ _____
 Height (mm): 200 _____
 Height (in): 7 ⁷/₈ _____
 Max. Overall Height (mm): 2200 _____
 Max. Overall Height (in): 86 ⁵/₈ _____
 Weight (kg): 1.5 _____
 Weight (lbs): 3.31 _____
 Diffuser: Satin Glass _____
 Fixture Finish: BEI / BLK / BLU / COG / DGN / GRY / MRN / MOC / MUS / OLV / SIL / STN / TER / WHI _____
 Holder Finish: MBK _____
 Accent Finish: MBK _____
 Fixture Material: Fabric Cord / Metal _____
 Primary Material: Fabric - Recycled _____
 Cable Details: 2000mm / 78 3/4" Cable - Transparent _____
 Upon Request: Matte White Holder _____

ELECTRICAL

Number of Lamps: 1 _____
 Lamp Type: LED Retrofit _____
 Lamp Shape: A19 _____
 Bulb Included: Bulb Not Included _____
 Max. Wattage Per Lamp (W): 15 _____
 Lamp Base: E26 _____
 Input Voltage (V): 120 _____
 Upon Request: 277Vac / GU24 _____

LED

OPTICAL

RATINGS AND CERTIFICATIONS

Certified By: Certified for North American Standards _____
 IP rating: IP20 _____



BANYO SUSPENSION

D111000-

PROJECT

TYPE

SPECIFIER

QUANTITY

DATE



D

PROJECT	
TYPE	
SPECIFIER	
QUANTITY	
DATE	

BANYO SUSPENSION

D111000- : D111000-MBK-MRN

base number

- To build a product code in our configurator select the specify button on the base model # product page
- To build a manual product code on this datasheet choose from the options listed below in blue font and add the suffix to the base model #

GENERAL

Series: Banyo
 Partner: Ole
 Division: Design
 Installation: Suspension
 Product Type: Pendant
 Mounting Location: Ceiling
 Light Distribution: Direct

PHYSICAL

Shape: Dome
 Diameter (mm): 300
 Diameter (in): 11 ¹³/₁₆
 Height (mm): 200
 Height (in): 7 ⁷/₈
 Max. Overall Height (mm): 2200
 Max. Overall Height (in): 86 ⁵/₈
 Weight (kg): 1.5
 Weight (lbs): 3.31
 Diffuser: Satin Glass / Shade - White
 Fixture Material: Fabric Cord / Metal
 Primary Material: Fabric - Recycled
 Cable Details: 2000mm / 78 3/4" Cable - Transparent

ELECTRICAL

Number of Lamps: 1
 Lamp Type: LED Retrofit
 Lamp Shape: A19
 Bulb Included: Bulb Not Included
 Total Output Wattage (W): 15
 Max. Wattage Per Lamp (W): 15
 Lamp Base: E26
 Input Voltage (V): 120
 Upon Request: 277Vac / GU24

LED

OPTICAL

RATINGS AND CERTIFICATIONS

Certified By: Certified for North American Standards
 IP rating: IP20

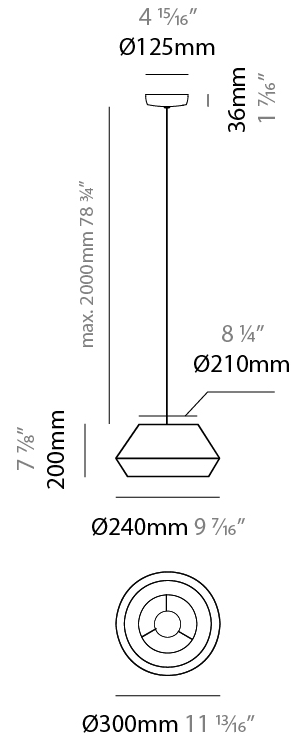

BANYO SUSPENSION

D111000- : D111000-MBK-MRN

PROJECT

TYPE

SPECIFIER

QUANTITY

DATE



D

PROJECT	_____
TYPE	_____
SPECIFIER	_____
QUANTITY	_____
DATE	_____

BANYO PORTABLE

D114004-

base number _____
 Finish Options _____

- To build a product code in our configurator select the specify button on the base model # product page
- To build a manual product code on this datasheet choose from the options listed below in blue font and add the suffix to the base model #

GENERAL

Series: Banyo _____
 Partner: Ole _____
 Division: Design _____
 Installation: Portable _____
 Product Type: Table _____
 Mounting Location: Table _____
 Light Distribution: Indirect _____

PHYSICAL

Shape: Dome _____
 Diameter (mm): 300 _____
 Diameter (in): 11 ¹³/₁₆ _____
 Height (mm): 490 _____
 Height (in): 19 ⁵/₁₆ _____
 Weight (kg): 1.7 _____
 Weight (lbs): 3.7 _____
 Diffuser: Satin Glass _____
 Fixture Finish: BEI / BLK / BLU / COG / DGN / GRY / MRN / MOC / MUS / OLV / SIL / STN / TER / WHI _____
 Holder Finish: Granulated White _____
 Fixture Material: Fabric Cord / Metal _____
 Primary Material: Fabric - Recycled _____
 Upon Request: Other fabric cord colors available upon request (see downloadable finish chart) _____

ELECTRICAL

Number of Lamps: 1 _____
 Lamp Type: LED Retrofit _____
 Lamp Shape: A19 _____
 Bulb Included: Bulb Not Included _____
 Max. Wattage Per Lamp (W): 15 _____
 Lamp Base: E26 _____
 Input Voltage (V): 120 _____
 Upon Request: 277Vac / GU24 _____

LED

OPTICAL

RATINGS AND CERTIFICATIONS

Certified By: Certified for North American Standards _____
 IP rating: IP20 _____

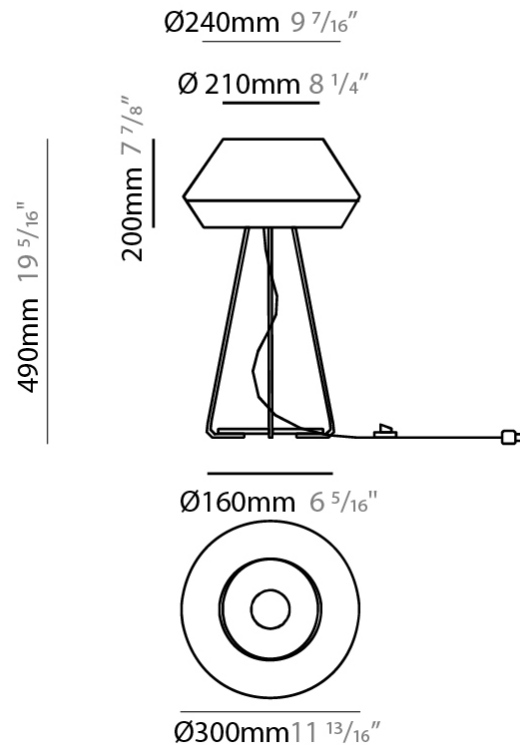

D114004-

PROJECT

TYPE

SPECIFIER

QUANTITY

DATE

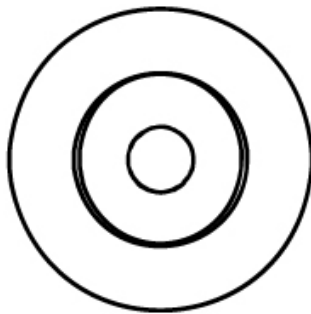
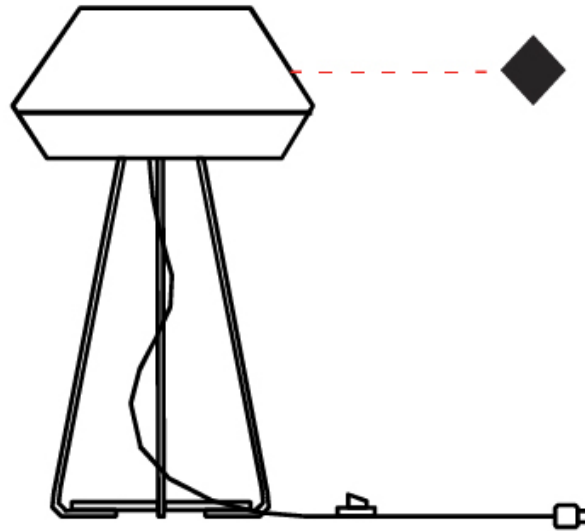

D

BANYO COLOR FINISH CHART

PROJECT _____
TYPE _____
SPECIFIER _____
QUANTITY _____
DATE _____

Fixture Finish

Beige - BEI



Black - BLK



Blue - BLU



Cognac - COG



Dark Green - DGN



Gray - GRY

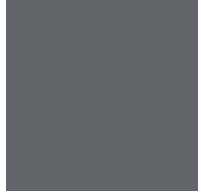

Maroon - MRN



Mocha - MOC



Mustard - MUS



Olive - OLV



Silver - SIL



Stone - STN



Terracotta - TER



White - WHI

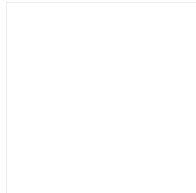

Holder Finish

Matte Black - MBK

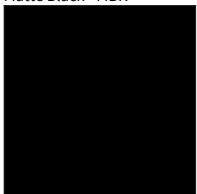

BANYO PORTABLE, SUSPENSION COLOR FINISH CHART

PROJECT

TYPE

SPECIFIER

QUANTITY

DATE

Accent Finish

Matte Black - MBK

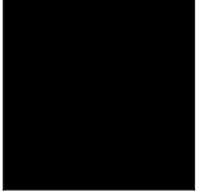

Digital: Not all screens are calibrated the same, and therefore, colors will appear differently between screens.

Physical: When texture is involved, there will be variations in color, character and tone within a product series and between product families.



COMPLETE COLOR FINISH CHART

Standard Colors of Recycles Cords

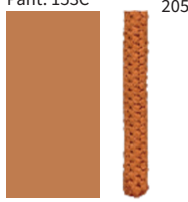
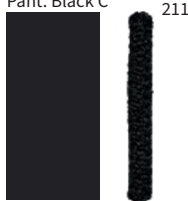
<p>STONE Pant. 7582C</p>  <p>1196</p>	<p>BEIGE Pant. 727C</p>  <p>196</p>	<p>MUSTARD Pant. 1245C</p>  <p>168</p>	<p>TERRACOTTA Pant. 153C</p>  <p>205</p>	<p>MAROON Pant. 1955C</p>  <p>224</p>
<p>WHITE Pant. White</p>  <p>71</p>	<p>OLIVE Pant. 5625C</p>  <p>323</p>	<p>DARK GREEN Pant. 5615C</p>  <p>301</p>	<p>MOCHA Pant. 7504C</p>  <p>175</p>	<p>COGNAC Pant. 181C</p>  <p>255</p>
<p>BLUE Pant. 663C</p>  <p>61</p>	<p>SILVER Pant. Cool Gray 7C</p>  <p>129</p>	<p>GREY Pant. Cool Gray 10C</p>  <p>120</p>	<p>BLACK Pant. Black C</p>  <p>211</p>	

Sustainable Thin Cord



Standard Colors with [S-]

Other fabric cord colors available upon request. Price increase and minimum quantities may apply

Digital: Not all screens are calibrated the same, and therefore, colors will appear differently between screens.

Physical: When texture is involved, there will be variations in color, character and tone within a product series and between product families.

Zaneen Group Inc. © 2024, T 1800-388-3382, F 416-247-9319, www.zaneen.com

Available for International specifications by adding 'INT' at the end of the existing Model #. For assistance on 'custom' specifications, contact zteam@zaneen.com.

In a constant effort to supply the best product, we reserve the right to change specifications or materials without notice. The most recent specification sheets are found at zaneen.com

COMPLETE COLOR FINISH CHART

Special Colors (for indoor use only)

<p>CRISTAL Pant. Glass 75</p> 	<p>Crudo Pant. 7401C 170</p> 	<p>ORO Pant. 872C 16</p> 	<p>GOLDEN Pant. 7403C 7</p> 	<p>AVELLANA Pant. 1955C 152</p> 
<p>ALPACA Pant. 429C 1401</p> 	<p>ARENA Pant. 465C 151</p> 	<p>CASTOR Pant. P7530C 167</p> 	<p>TABACO Pant. 1545C 203</p> 	<p>MARRON Pant. 476C 187</p> 
<p>TUNEL Pant. Black 7C 169</p> 	<p>BURDEOS Pant. 188C 163</p> 	<p>FRESILLA Pant. 695C 273</p> 	<p>ARCILLA Pant. 1675C 205</p> 	<p>SATAN Pant. 207C 19</p> 
<p>MUSGO Pant. 5535C 320</p> 	<p>NOCTURNO Pant. 7547 66</p> 	<p>MEDAS Pant. 295C 168</p> 	<p>LAVA Pant. 151C 1334</p> 	<p>FUEGO Pant. 185C 245</p> 
<p>VERDE OSCURO Pant. 3298C 358</p> 	<p>MARINO Pant. 289C 63</p> 	<p>AZUL ELECTRICO Pant. 2945C 168</p> 	<p>CALABAZA Pant. 158C 84</p> 	<p>ROJO Pant. 186C 241</p> 
<p>JUNGLA Pant. 356C 310</p> 	<p>AZUL ROYAL Pant. 288C 1075</p> 	<p>VIOLETA Pant. 7676U 147</p> 	<p>AMARILLO Pant. 109U 1</p> 	<p>CICLAMOR Pant. 205C 264</p> 

Standard Colors with [-]

Other fabric cord colors available upon request. Price increase and minimum quantities may apply

Digital: Not all screens are calibrated the same, and therefore, colors will appear differently between screens.

Physical: When texture is involved, there will be variations in color, character and tone within a product series and between product families.

Zaneen Group Inc. © 2024, T 1800-388-3382, F 416-247-9319, www.zaneen.com











Available for International specifications by adding 'INT' at the end of the existing Model #. For assistance on 'custom' specifications, contact zteam@zaneen.com.

In a constant effort to supply the best product, we reserve the right to change specifications or materials without notice. The most recent specification sheets are found at zaneen.com

LEGEND

	floor-mounted		pivotal		special LED (upon request) RGB, RGBW, tunable, gold+, meat+, art+, fashion+
	wall and ceiling: recessed and surface mounted		rotating		warm dim / natural dimming LED
	ceiling-mounted and wall-mounted		illuminate tilted		rechargeable battery powered
	wall-mounted		color of suspension cable		fixture with natural vivid LED (upon request)
	omni-directional light distribution		length of suspension cable		color rendering index
	direct light distribution		reflector degree selection		color temperature
	direct/indirect light distribution		super spot		lumen (luminous flux)
	indirect light distribution		lens		efficacy (lumens per watt)
	asymmetric light distribution		lens pack		Unified Glare Rating (UGR) range from 5-40
	aura light distribution		shine ring		marine grade (AISI 316 stainless steel)
	round wall or ceiling cut-out		integrated shine ring with diffuser		walk on
	square wall or ceiling cut-out		free individual colors 01-29		drive on
	the supplied jig specifies the cutout dimensions		individual colors: 00 (free of charge), 01-25 (extra charge)		Dark Sky Compliance
	minimum distance (meters) lamp - object		luminaire part to be colored (F1)		Americans with Disabilities Act (less than 4" off the wall located between 27"-84" from floor)
	recessed depth		luminaire part to be colored (F2)		lamp protected against explosion
	ceiling thickness in mm		luminaire part to be colored (F3)		blown glass using traditional methods by master glass blower
	ceiling thickness selection		luminaire part to be colored (F4)		acoustic material
	dimnable DP (phase), DV (0-10V), DD (dali), DS (step-dim)		luminaire part to be colored (F5)		protection class I, protection insulation
	included or excluded LED driver/transformer/control gear		color of 3-circuit adaptor		protection class II, protection insulation
	separately switchable		indirect diffuser		ETL Certified to UL and CSA Standards
	sensor		direct diffuser		UL Certified to UL and CSA Standards
	remote control		ball-proof (upon request)		CSA Certified to UL and CSA Standards
	available upon request		accessory		Certified for North American Standards

IP RATING

	protected against ingress of solid bodies greater than 12.5mm (finger)
	protected against ingress of solid bodies greater than 2.5mm protected against sprays of water up to 60 degrees from the vertical (rain)
	protected against ingress of solid bodies greater than 1mm (wire) no protection against the ingress of moisture
	protected against ingress of solid bodies greater than 1mm (wire) protected against sprays of water up to 60 degrees from the vertical (rain)
	protected against ingress of solid bodies greater than 1mm (wire) protected against water splashed from all directions
	protected against limited ingress of dust (wet rooms/covered outdoor areas) protected against water splashed from all directions
	protected against ingress of dust protected against jets of water
	protected against ingress of dust protected against powerful jets of water or heavy seas
	protected against ingress of dust protected against immersion of water between 15cm - 1m for 30 minutes
	protected against ingress of dust protected against immersion of water under pressure for long periods

IK RATING

	protected against 0.14 joules impact (equivalent to 0.25kg mass dropped from 56mm above the surface)
	protected against 0.2 joules impact (equivalent to 0.25kg mass dropped from 80mm above the surface)
	protected against 0.35 joules impact (equivalent to 0.25kg mass dropped from 140mm above the surface)
	protected against 0.5 joules impact (equivalent to 0.25kg mass dropped from 200mm above the surface)
	protected against 0.7 joules impact (equivalent to 0.25kg mass dropped from 280mm above the surface)
	protected against 1 joules impact (equivalent to 0.25kg mass dropped from 400mm above the surface)
	protected against 2 joules impact (equivalent to 0.5kg mass dropped from 400mm above the surface)
	protected against 5 joules impact (equivalent to 1.7kg mass dropped from 300mm above the surface)
	protected against 10 joules impact (equivalent to 5.0kg mass dropped from 200mm above the surface)
	protected against 20 joules impact (equivalent to 5.0kg mass dropped from 400mm above the surface)