

|           |       |
|-----------|-------|
| PROJECT   | _____ |
| TYPE      | _____ |
| SPECIFIER | _____ |
| QUANTITY  | _____ |
| DATE      | _____ |

## BANYO SUSPENSION

### D111002-

base number                      Finish                       
Options                     

- To build a product code in our configurator select the specify button on the base model # product page
- To build a manual product code on this datasheet choose from the options listed below in blue font and add the suffix to the base model #

#### GENERAL

Series: Banyo \_\_\_\_\_  
 Partner: Ole \_\_\_\_\_  
 Division: Design \_\_\_\_\_  
 Installation: Suspension \_\_\_\_\_  
 Product Type: Pendant \_\_\_\_\_  
 Mounting Location: Ceiling \_\_\_\_\_  
 Light Distribution: Direct \_\_\_\_\_

#### PHYSICAL

Shape: Dome \_\_\_\_\_  
 Diameter (mm): 750 \_\_\_\_\_  
 Diameter (in): 29 1/2 \_\_\_\_\_  
 Height (mm): 350 \_\_\_\_\_  
 Height (in): 13 3/4 \_\_\_\_\_  
 Max. Overall Height (mm): 2350 \_\_\_\_\_  
 Max. Overall Height (in): 92 1/2 \_\_\_\_\_  
 Weight (kg): 10 \_\_\_\_\_  
 Weight (lbs): 22.05 \_\_\_\_\_  
 Diffuser: Satin Glass \_\_\_\_\_  
 Fixture Finish: BEI / BLK / BLU / COG / DGN / GRY / MRN / MOC / MUS / OLV / SIL / STN / TER / WHI \_\_\_\_\_  
 Holder Finish: MBK \_\_\_\_\_  
 Accent Finish: MBK \_\_\_\_\_  
 Fixture Material: Fabric Cord / Metal \_\_\_\_\_  
 Primary Material: Fabric - Recycled \_\_\_\_\_  
 Cable Details: 2000mm/78 3/4" Cable - Transparent \_\_\_\_\_  
 Upon Request: Matte White Holder \_\_\_\_\_

#### ELECTRICAL

Number of Lamps: 3 \_\_\_\_\_  
 Lamp Type: LED Retrofit \_\_\_\_\_  
 Lamp Shape: A19 \_\_\_\_\_  
 Bulb Included: Bulb Not Included \_\_\_\_\_  
 Max. Wattage Per Lamp (W): 15 \_\_\_\_\_  
 Lamp Base: E26 \_\_\_\_\_  
 Input Voltage (V): 120 \_\_\_\_\_  
 Upon Request: 277Vac / GU24 \_\_\_\_\_

#### LED

#### OPTICAL

#### RATINGS AND CERTIFICATIONS

Certified By: Certified for North American Standards \_\_\_\_\_  
 IP rating: IP20 \_\_\_\_\_

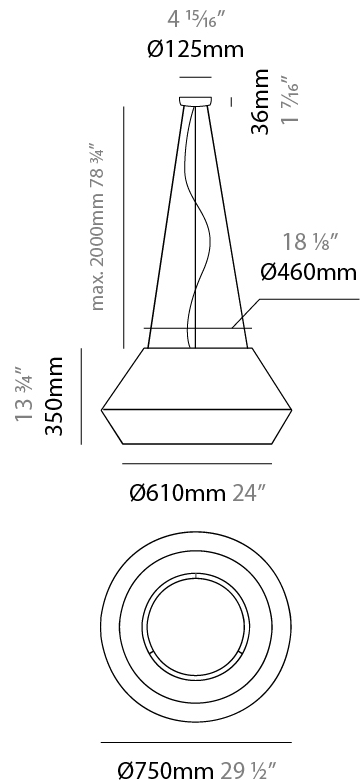

## BANYO SUSPENSION

D111002-

|           |       |
|-----------|-------|
| PROJECT   | _____ |
| TYPE      | _____ |
| SPECIFIER | _____ |
| QUANTITY  | _____ |
| DATE      | _____ |

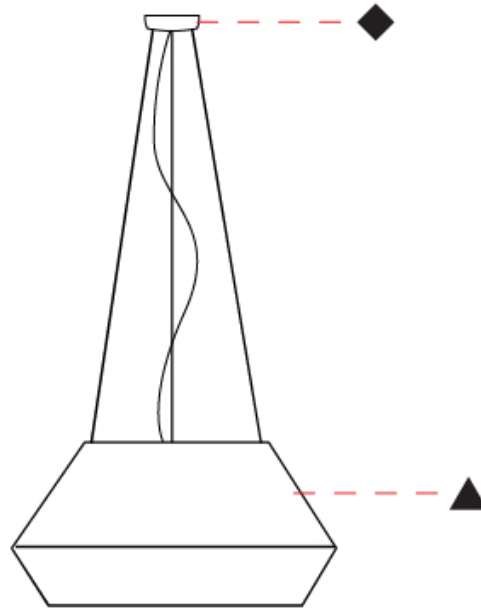

D

## BANYO SUSPENSION

### D111003-

base number Finish  
Options

- To build a product code in our configurator select the specify button on the base model # product page
- To build a manual product code on this datasheet choose from the options listed below in blue font and add the suffix to the base model #

#### GENERAL

Series: Banyo  
 Partner: Ole  
 Division: Design  
 Installation: Suspension  
 Product Type: Pendant  
 Mounting Location: Ceiling  
 Light Distribution: Direct

#### PHYSICAL

Shape: Disc  
 Diameter (mm): 750  
 Diameter (in): 29 1/2  
 Height (mm): 140  
 Height (in): 5 1/2  
 Max. Overall Height (mm): 2140  
 Max. Overall Height (in): 84 1/4  
 Weight (kg): 10  
 Weight (lbs): 22.05  
 Diffuser: Satin Glass  
 Fixture Finish: BEI / BLK / BLU / COG / DGN / GRY / MRN / MOC / MUS / OLV / SIL / STN / TER / WHI  
 Holder Finish: MBK  
 Accent Finish: MBK  
 Fixture Material: Fabric Cord / Metal  
 Primary Material: Fabric - Recycled  
 Cable Details: 2000mm/78 3/4" Cable - Transparent  
 Upon Request: Matte White Holder

#### ELECTRICAL

Number of Lamps: 3  
 Lamp Type: LED Retrofit  
 Lamp Shape: A19  
 Bulb Included: Bulb Not Included  
 Max. Wattage Per Lamp (W): 15  
 Lamp Base: E26  
 Input Voltage (V): 120  
 Upon Request: 277Vac / GU24

#### LED

#### OPTICAL

#### RATINGS AND CERTIFICATIONS

Certified By: Certified for North American Standards  
 IP rating: IP20

|           |
|-----------|
| PROJECT   |
| TYPE      |
| SPECIFIER |
| QUANTITY  |
| DATE      |

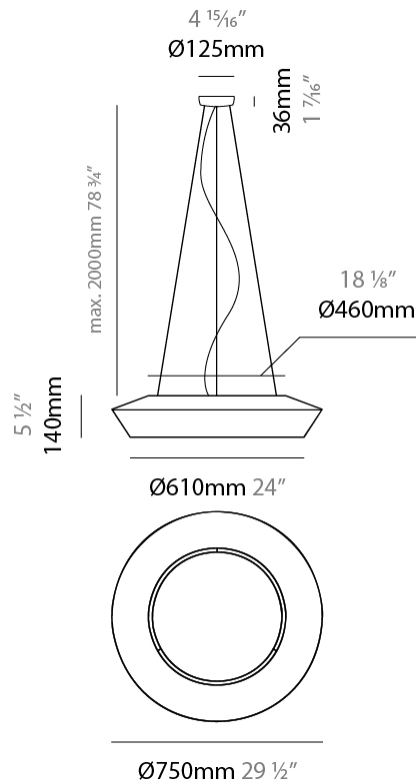

## BANYO SUSPENSION

D111003-

PROJECT \_\_\_\_\_

TYPE \_\_\_\_\_

SPECIFIER \_\_\_\_\_

QUANTITY \_\_\_\_\_

DATE \_\_\_\_\_

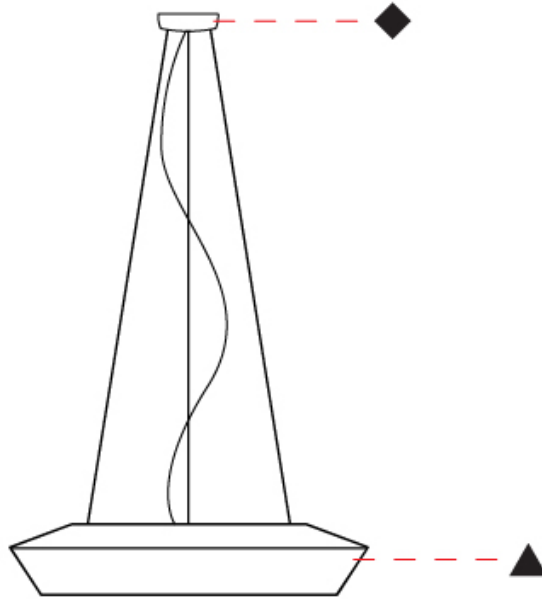

D

|           |       |
|-----------|-------|
| PROJECT   | _____ |
| TYPE      | _____ |
| SPECIFIER | _____ |
| QUANTITY  | _____ |
| DATE      | _____ |

### Fixture Finish

Beige - BEI



Black - BLK



Blue - BLU



Cognac - COG



Dark Green - DGN



Gray - GRY



Maroon - MRN



Mocha - MOC



Mustard - MUS



Olive - OLV



Silver - SIL



Stone - STN



Terracotta - TER



White - WHI



### Holder Finish

Matte Black - MBK



## BANYO SUSPENSION COLOR FINISH CHART

PROJECT

TYPE

SPECIFIER

QUANTITY

DATE

### Accent Finish

Matte Black - MBK

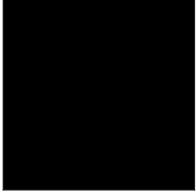

**Digital:** Not all screens are calibrated the same, and therefore, colors will appear differently between screens.

**Physical:** When texture is involved, there will be variations in color, character and tone within a product series and between product families.



## COMPLETE COLOR FINISH CHART

### Standard Colors of Recycles Cords



### Sustainable Thin Cord



Standard Colors with [S-]

Other fabric cord colors available upon request. Price increase and minimum quantities may apply

**Digital:** Not all screens are calibrated the same, and therefore, colors will appear differently between screens.

**Physical:** When texture is involved, there will be variations in color, character and tone within a product series and between product families.

Zaneen Group Inc. © 2024, T 1800-388-3382, F 416-247-9319, [www.zaneen.com](http://www.zaneen.com)

Available for International specifications by adding 'INT' at the end of the existing Model #. For assistance on 'custom' specifications, contact [zteam@zaneen.com](mailto:zteam@zaneen.com).

In a constant effort to supply the best product, we reserve the right to change specifications or materials without notice. The most recent specification sheets are found at [zaneen.com](http://zaneen.com)

## COMPLETE COLOR FINISH CHART

Special Colors (for indoor use only)

|   |   |   |  |  |
|---|---|---|--|--|
| CRISTAL<br>Pant. Glass<br>75<br>         | Crudo<br>Pant. 7401C<br>170<br>        | ORO<br>Pant. 872C<br>16<br>                | GOLDEN<br>Pant. 7403C<br>7<br>     | AVELLANA<br>Pant. 1955C<br>152<br>  |
| ALPACA<br>Pant. 429C<br>1401<br>         | ARENA<br>Pant. 465C<br>151<br>         | CASTOR<br>Pant. P7530C<br>167<br>          | TABACO<br>Pant. 1545C<br>203<br>   | MARRON<br>Pant. 476C<br>187<br>     |
| TUNEL<br>Pant. Black 7C<br>169<br>      | BURDEOS<br>Pant. 188C<br>163<br>      | FRESILLA<br>Pant. 695C<br>273<br>         | ARCILLA<br>Pant. 1675C<br>205<br> | SATAN<br>Pant. 207C<br>19<br>      |
| MUSGO<br>Pant. 5535C<br>320<br>        | NOCTURNO<br>Pant. 7547<br>66<br>     | MEDAS<br>Pant. 295C<br>168<br>           | LAVA<br>Pant. 151C<br>1334<br>   | FUEGO<br>Pant. 185C<br>245<br>    |
| VERDE OSCURO<br>Pant. 3298C<br>358<br> | MARINO<br>Pant. 289C<br>63<br>       | AZUL ELECTRICO<br>Pant. 2945C<br>168<br> | CALABAZA<br>Pant. 158C<br>84<br> | ROJO<br>Pant. 186C<br>241<br>     |
| JUNGLA<br>Pant. 356C<br>310<br>        | AZUL ROYAL<br>Pant. 288C<br>1075<br> | VIOLETA<br>Pant. 7676U<br>147<br>        | AMARILLO<br>Pant. 109U<br>1<br>  | CICLAMOR<br>Pant. 205C<br>264<br> |

Standard Colors with [S-]

Other fabric cord colors available upon request. Price increase and minimum quantities may apply

**Digital:** Not all screens are calibrated the same, and therefore, colors will appear differently between screens.

**Physical:** When texture is involved, there will be variations in color, character and tone within a product series and between product families.

Zaneen Group Inc. © 2024, T 1800-388-3382, F 416-247-9319, [www.zaneen.com](http://www.zaneen.com)











Available for International specifications by adding "INT" at the end of the existing Model #. For assistance on 'custom' specifications, contact [zteam@zaneen.com](mailto:zteam@zaneen.com).

In a constant effort to supply the best product, we reserve the right to change specifications or materials without notice. The most recent specification sheets are found at [zaneen.com](http://zaneen.com)

### LEGEND

|  |   |   |  |   |  |
|--|---|---|--|---|--|
|    | floor-mounted   |    | pivotal  |    | special LED (upon request) RGB, RGBW, tunable, gold+, meat+, art+, fashion+                    |
|    | wall and ceiling: recessed and surface mounted            |    | rotating   |    | warm dim / natural dimming LED   |
|    | ceiling-mounted and wall-mounted                          |    | illuminate tilted  |    | rechargeable battery powered   |
|    | wall-mounted  |    | color of suspension cable                                    |    | fixture with natural vivid LED (upon request)  |
|    | omni-directional light distribution                       |    | length of suspension cable                                   |    | color rendering index  |
|    | direct light distribution                                 |    | reflector degree selection                                   |    | color temperature  |
|    | direct/indirect light distribution                        |    | super spot   |    | lumen (luminous flux)  |
|    | indirect light distribution                               |    | lens   |    | efficacy (lumens per watt)   |
|    | asymmetric light distribution                             |    | lens pack  |    | Unified Glare Rating (UGR) range from 5-40   |
|    | aura light distribution                                   |    | shine ring   |    | marine grade (AISI 316 stainless steel)  |
|    | round wall or ceiling cut-out                             |    | integrated shine ring with diffuser                          |    | walk on  |
|    | square wall or ceiling cut-out                            |    | free individual colors 01-29                                 |    | drive on   |
|    | the supplied jig specifies the cutout dimensions          |    | individual colors: 00 (free of charge), 01-25 (extra charge) |    | Dark Sky Compliance  |
|    | minimum distance (meters) lamp - object                   |    | luminaire part to be colored (F1)                            |    | Americans with Disabilities Act (less than 4" off the wall located between 27"-84" from floor) |
|    | recessed depth  |    | luminaire part to be colored (F2)                            |    | lamp protected against explosion   |
|   | ceiling thickness in mm                                   |   | luminaire part to be colored (F3)                            |   | blown glass using traditional methods by master glass blower                                   |
|  | ceiling thickness selection                               |  | luminaire part to be colored (F4)                            |  | acoustic material  |
|  | dimnable DP (phase), DV (0-10V), DD (dali), DS (step-dim) |  | luminaire part to be colored (F5)                            |  | protection class I, protection insulation  |
|  | included or excluded LED driver/transformer/control gear  |  | color of 3-circuit adaptor                                   |  | protection class II, protection insulation   |
|  | separately switchable                                     |  | indirect diffuser  |  | ETL Certified to UL and CSA Standards  |
|  | sensor  |  | direct diffuser  |  | UL Certified to UL and CSA Standards   |
|  | remote control  |  | ball-proof (upon request)                                    |  | CSA Certified to UL and CSA Standards  |
|  | available upon request                                    |  | accessory  |  | Certified for North American Standards   |

### IP RATING

|   |  |
|---|--|
|  | protected against ingress of solid bodies greater than 12.5mm (finger)   |
|  | protected against ingress of solid bodies greater than 2.5mm<br>protected against sprays of water up to 60 degrees from the vertical (rain)      |
|  | protected against ingress of solid bodies greater than 1mm (wire)<br>no protection against the ingress of moisture                               |
|  | protected against ingress of solid bodies greater than 1mm (wire)<br>protected against sprays of water up to 60 degrees from the vertical (rain) |
|  | protected against ingress of solid bodies greater than 1mm (wire)<br>protected against water splashed from all directions                        |
|  | protected against limited ingress of dust (wet rooms/covered outdoor areas)<br>protected against water splashed from all directions              |
|  | protected against ingress of dust<br>protected against jets of water   |
|  | protected against ingress of dust<br>protected against powerful jets of water or heavy seas  |
|  | protected against ingress of dust<br>protected against immersion of water between 15cm - 1m for 30 minutes                                       |
|  | protected against ingress of dust<br>protected against immersion of water under pressure for long periods  |

### IK RATING

|   |   |
|---|---|
|  | protected against 0.14 joules impact (equivalent to 0.25kg mass dropped from 56mm above the surface)  |
|  | protected against 0.2 joules impact (equivalent to 0.25kg mass dropped from 80mm above the surface)   |
|  | protected against 0.35 joules impact (equivalent to 0.25kg mass dropped from 140mm above the surface) |
|  | protected against 0.5 joules impact (equivalent to 0.25kg mass dropped from 200mm above the surface)  |
|  | protected against 0.7 joules impact (equivalent to 0.25kg mass dropped from 280mm above the surface)  |
|  | protected against 1 joules impact (equivalent to 0.25kg mass dropped from 400mm above the surface)    |
|  | protected against 2 joules impact (equivalent to 0.5kg mass dropped from 400mm above the surface)     |
|  | protected against 5 joules impact (equivalent to 1.7kg mass dropped from 300mm above the surface)     |
|  | protected against 10 joules impact (equivalent to 5.0kg mass dropped from 200mm above the surface)    |
|  | protected against 20 joules impact (equivalent to 5.0kg mass dropped from 400mm above the surface)    |