

BUNGA SUSPENSION

A30695-

base number LED Dimming Color Temperature Finishes (Diamond) Finishes (Triangle) Cable Options

- To build a product code in our configurator select the specify button on the base model # product page
- To build a manual product code on this datasheet choose from the options listed below in blue font and add the suffix to the base model #

GENERAL

Series: Bunga
 Brand: Prolicht
 Division: Architectural
 Mounting Type: Suspension
 Mounting Location: Ceiling
 Subcategory: Profile

PHYSICAL

Shape: Cylinder
 Length (mm): 900
 Length (in): 35 7/16
 Width (mm): 115
 Width (in): 4 1/2
 Height (mm): 115
 Height (in): 4 1/2
 Max. Overall Height (mm): 2115
 Max. Overall Height (in): 83 1/4
 Light Distribution: Omnidirectional
 Weight (kg): 3.308
 Weight (lbs): 7.28
 Diffuser: PMMA - Opal
 Fixture Finish: [SSR / BKV / CWI / CRY / HAB / UFT / ITA / RUA / FTG / MYG / LOD / PUS / FRO / FUP / KIA / POP / BLS / SPG / MEY / GOH / GUM / CHC / COM / ABZ / JAG / OBR / MOS / ROR](#)
 Fixture Material: Aluminum
 Cable Details: [2000mm or 6000mm Transparent Cable](#)
 Upon Request: Cable colour - White / Black / Orange / Red

ELECTRICAL

Lamp Type: LED (Zhaga Standard)
 Input Wattage (W): 15
 Total Output Wattage (W): 12 / 11.1 (3500K)
 Dimming: [Non-Dimming / Phase Dimming \(120Vac only\) / 0-10V Dimming](#)
 Driver Included: Yes
 Driver Location: Integrated
 Driver Type: Constant Current - 120 / 277Vac
 Driver Class: Class 2
 Input Voltage (V): 120 - 277
 Constant Current (MA): 350 / 375 (3500K)

LED

Color Temperature (°K): [3000 / 3500 / 4000](#)
 Max. Delivered Lumen (lm): 1660 / 1715 / 1750
 CRI: >80 CRI
 Lamp Life (hrs): 50000

OPTICAL

RATINGS AND CERTIFICATIONS

Certified By: Certified for North American Standards
 IP rating: IP20

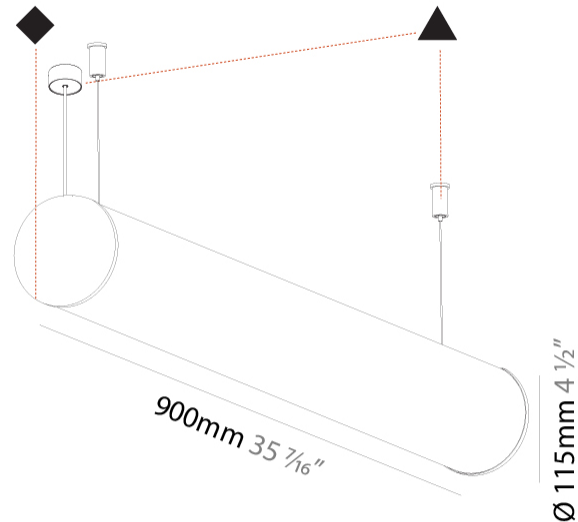

BUNGA SUSPENSION

A30695-

PROJECT

TYPE

SPECIFIER

QUANTITY

DATE



A

| |
|-----------|
| PROJECT |
| TYPE |
| SPECIFIER |
| QUANTITY |
| DATE |

BUNGA SURFACE

A3D118-

| | | | |
|-------------|----------------|----------------------|-----------------------|
| base number | LED Dimming | Color Temperature | Finishes (Diamond) |
|-------------|----------------|----------------------|-----------------------|

- To build a product code in our configurator select the specify button on the base model # product page
- To build a manual product code on this datasheet choose from the options listed below in blue font and add the suffix to the base model #

GENERAL

| |
|----------------------------|
| Series: Bunga |
| Brand: Prolicht |
| Division: Architectural |
| Mounting Type: Surface |
| Mounting Location: Ceiling |
| Subcategory: Profile |

PHYSICAL

| |
|---|
| Shape: Cylinder |
| Diameter (mm): 115 |
| Diameter (in): 4 1/2 |
| Length (mm): 900 |
| Length (in): 35 7/16 |
| Height (mm): 108 |
| Height (in): 4 1/4 |
| Light Distribution: Omnidirectional |
| Weight (kg): 2.954 |
| Weight (lbs): 6.512 |
| Diffuser: PMMA - Opal |
| Fixture Finish: SSR / BKV / CWI / CRY / HAB / UFT / ITA / RUA / FTG / MYG / LOD / PUS / FRO / FUP / KIA / POP / BLS / SPG / MEY / GOH / GUM / CHC / COM / ABZ / JAG / OBR / MOS / ROR |
| Fixture Material: Aluminum |

ELECTRICAL

| |
|--|
| Lamp Type: LED (Zhaga Standard) |
| Input Wattage (W): 15 |
| Total Output Wattage (W): 12 / 11.2 (3500K) |
| Dimming: Non-Dimming / Phase Dimming (120Vac only) / 0-10V Dimming |
| Driver Included: Yes |
| Driver Location: Integrated |
| Driver Type: Constant Current - 120 / 277Vac |
| Driver Class: Class 2 |
| Input Voltage (V): 120 - 277 |
| Constant Current (MA): 350 / 325 (3500K) |

LED

| |
|---|
| Color Temperature (°K): 3000 / 3500 / 4000 |
| Max. Delivered Lumen (lm): 1660 / 1715 / 1750 |
| CRI: >80 CRI |
| Lamp Life (hrs): 50000 |

OPTICAL

RATINGS AND CERTIFICATIONS

| |
|--|
| Certified By: Certified for North American Standards |
| IP rating: IP20 |

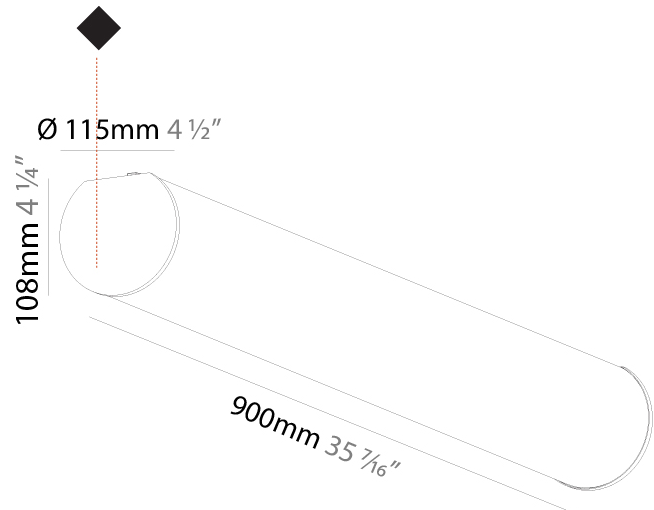

A3D118-

PROJECT

TYPE

SPECIFIER

QUANTITY

DATE



BUNGA COLOR FINISH CHART

| |
|-----------|
| PROJECT |
| TYPE |
| SPECIFIER |
| QUANTITY |
| DATE |

Fixture Finish



Digital: Not all screens are calibrated the same, and therefore, colors will appear differently between screens.

Physical: When texture is involved, there will be variations in color, character and tone within a product series and between product families.

Gun Metal: No Gun Metal finish is alike. It combines a mixture of transparent and black color particles which ensures a highly individual effect and no luminaire being identical.

Champagne Cream, Copper Mine, Ancient Bronze + Jazz Gold: These finishes have slight fading from specific powder coating production. Each luminaire will slightly vary.



| | |
|-----------|--|
| PROJECT | |
| TYPE | |
| SPECIFIER | |
| QUANTITY | |
| DATE | |

LEGEND

| | | |
|---|--|--|
| floor-mounted | pivotal | special LED (upon request) RGB, RGBW, tunable, gold+, meat+, art+, fashion+ |
| wall and ceiling: recessed and surface mounted | rotating | warm dim / natural dimming LED |
| ceiling-mounted and wall-mounted | illuminate tilted | rechargeable battery powered |
| wall-mounted | color of suspension cable | fixture with natural vivid LED (upon request) |
| omni-directional light distribution | length of suspension cable | color rendering index |
| direct light distribution | reflector degree selection | color temperature |
| direct/indirect light distribution | super spot | lumen (luminous flux) |
| indirect light distribution | lens | efficacy (lumens per watt) |
| asymmetric light distribution | lens pack | Unified Glare Rating (UGR) range from 5-40 |
| aura light distribution | shine ring | marine grade (AISI 316 stainless steel) |
| round wall or ceiling cut-out | integrated shine ring with diffuser | walk on |
| square wall or ceiling cut-out | free individual colors 01-29 | drive on |
| the supplied jig specifies the cutout dimensions | individual colors: 00 (free of charge), 01-25 (extra charge) | Dark Sky Compliance |
| minimum distance (meters) lamp - object | luminaire part to be colored (F1) | Americans with Disabilities Act (less than 4" off the wall located between 27"-84" from floor) |
| recessed depth | luminaire part to be colored (F2) | lamp protected against explosion |
| ceiling thickness in mm | luminaire part to be colored (F3) | blown glass using traditional methods by master glass blower |
| ceiling thickness selection | luminaire part to be colored (F4) | acoustic material |
| dimmable DP (phase), DV (0-10V), DD (dali), DS (step-dim) | luminaire part to be colored (F5) | protection class I, protection insulation |
| included or excluded LED driver/transformer/control gear | color of 3-circuit adaptor | protection class II, protection insulation |
| separately switchable | indirect diffuser | ETL Certified to UL and CSA Standards |
| sensor | direct diffuser | UL Certified to UL and CSA Standards |
| remote control | ball-proof (upon request) | CSA Certified to UL and CSA Standards |
| available upon request | accessory | Certified for North American Standards |

IP RATING

| | |
|------|--|
| IP20 | protected against ingress of solid bodies greater than 12.5mm (finger) |
| IP33 | protected against ingress of solid bodies greater than 2.5mm protected against sprays of water up to 60 degrees from the vertical (rain) |
| IP40 | protected against ingress of solid bodies greater than 1mm (wire) no protection against the ingress of moisture |
| IP43 | protected against ingress of solid bodies greater than 1mm (wire) protected against sprays of water up to 60 degrees from the vertical (rain) |
| IP44 | protected against ingress of solid bodies greater than 1mm (wire) protected against water splashed from all directions |
| IP54 | protected against limited ingress of dust (wet rooms/covered outdoor areas) protected against water splashed from all directions |
| IP65 | protected against ingress of dust protected against jets of water |
| IP66 | protected against ingress of dust protected against powerful jets of water or heavy seas |
| IP67 | protected against ingress of dust protected against immersion of water between 15cm - 1m for 30 minutes |
| IP68 | protected against ingress of dust protected against immersion of water under pressure for long periods |

IK RATING

| | |
|------|---|
| IK01 | protected against 0.14 joules impact (equivalent to 0.25kg mass dropped from 56mm above the surface) |
| IK02 | protected against 0.2 joules impact (equivalent to 0.25kg mass dropped from 80mm above the surface) |
| IK03 | protected against 0.35 joules impact (equivalent to 0.25kg mass dropped from 140mm above the surface) |
| IK04 | protected against 0.5 joules impact (equivalent to 0.25kg mass dropped from 200mm above the surface) |
| IK05 | protected against 0.7 joules impact (equivalent to 0.25kg mass dropped from 280mm above the surface) |
| IK06 | protected against 1 joules impact (equivalent to 0.25kg mass dropped from 400mm above the surface) |
| IK07 | protected against 2 joules impact (equivalent to 0.5kg mass dropped from 400mm above the surface) |
| IK08 | protected against 5 joules impact (equivalent to 1.7kg mass dropped from 300mm above the surface) |
| IK09 | protected against 10 joules impact (equivalent to 5.0kg mass dropped from 200mm above the surface) |
| IK10 | protected against 20 joules impact (equivalent to 5.0kg mass dropped from 400mm above the surface) |