

PROJECT
TYPE
SPECIFIER
QUANTITY
DATE

TOTEM DOT PORTABLE

A340010- -

base number Finishes (Diamond) Finishes (Triangle)

- To build a product code in our configurator select the specify button on the base model # product page
- To build a manual product code on this datasheet choose from the options listed below in blue font and add the suffix to the base model #

GENERAL

Series: Code _____
 Subseries: Totem Dot _____
 Brand: Prolicht _____
 Division: Architectural _____
 Mounting Type: Portable _____
 Mounting Location: Floor _____
 Subcategory: Ambient _____

PHYSICAL

Shape: Abstract _____
 Diameter (mm): 300 _____
 Diameter (in): 11 ¹³/₁₆ _____
 Height (mm): 2100 _____
 Height (in): 82 ¹¹/₁₆ _____
 Light Distribution: Omnidirectional _____
 Fixture Finish: SSR / BKV / CWI / CRY / HAB / UFT / ITA / RUA / FTG / MYG / LOD / PUS / FRO / FUP / KIA / POP / BLS / SPG / MEY / GOH / GUM / CHC / COM / ABZ / JAG / OBR / MOS / ROR _____
 Fixture Material: Aluminum _____

ELECTRICAL

Lamp Type: LED (Zhaga Standard) _____
 Input Wattage (W): 163 _____
 Total Output Wattage (W): 148.2 _____
 Dimming: Non-Dimmable _____
 Driver Included: Yes _____
 Driver Location: Integrated _____
 Driver Type: Constant Current - Universal _____
 Driver Class: Class 2 _____
 Input Voltage (V): 120 - 277 _____
 Constant Current (MA): 79 _____

LED

Color Temperature (°K): 2700 _____
 Max. Delivered Lumen (lm): 17550 _____
 Nominal Lumen (lm): 17550 _____
 CRI: >90 CRI _____
 Lamp Life (hrs): 50000 _____

OPTICAL

Beam Angle: 122 _____

RATINGS AND CERTIFICATIONS

Certified By: CSA Certified to UL and CSA Standards _____
 IP rating: IP20 _____



2077mm 81 3/4"

Ø290mm 11 7/16"



TOTEM DOT PORTABLE

A340010-

PROJECT _____

TYPE _____

SPECIFIER _____

QUANTITY _____

DATE _____



BEACON DOT PORTABLE

A340011- -

base number Finishes (Diamond) Finishes (Triangle)

- To build a product code in our configurator select the specify button on the base model # product page
- To build a manual product code on this datasheet choose from the options listed below in blue font and add the suffix to the base model #

GENERAL

Series: Code
 Subseries: Beacon Dot
 Brand: Prolicht
 Division: Architectural
 Mounting Type: Portable
 Mounting Location: Floor
 Subcategory: Ambient

PHYSICAL

Shape: Abstract
 Diameter (mm): 485
 Diameter (in): 19 1/8
 Height (mm): 2020
 Height (in): 79 1/2
 Light Distribution: Omnidirectional
 Fixture Finish: SSR / BKV / CWI / CRY / HAB / UFT / ITA / RUA / FTG / MYG / LOD / PUS / FRO / FUP / KIA / POP / BLS / SPG / MEY / GOH / GUM / CHC / COM / ABZ / JAG / OBR / MOS / ROR
 Fixture Material: Aluminum

ELECTRICAL

Lamp Type: LED (Zhaga Standard)
 Input Wattage (W): 62.7
 Total Output Wattage (W): 57.3
 Dimming: Non-Dimmable
 Driver Included: Yes
 Driver Location: Integrated
 Driver Type: Constant Current - Universal
 Driver Class: Class 2
 Input Voltage (V): 120 - 277
 Constant Current (MA): 79

LED

Color Temperature (°K): 2700
 Max. Delivered Lumen (lm): 6750
 Nominal Lumen (lm): 675
 CRI: >90 CRI
 Lamp Life (hrs): 50000

OPTICAL

Beam Angle: 122

RATINGS AND CERTIFICATIONS

Certified By: CSA Certified to UL and CSA Standards
 IP rating: IP20

PROJECT
TYPE
SPECIFIER
QUANTITY
DATE



Ø294mm 11 9/16"



BEACON DOT PORTABLE

A340011-

PROJECT _____

TYPE _____

SPECIFIER _____

QUANTITY _____

DATE _____

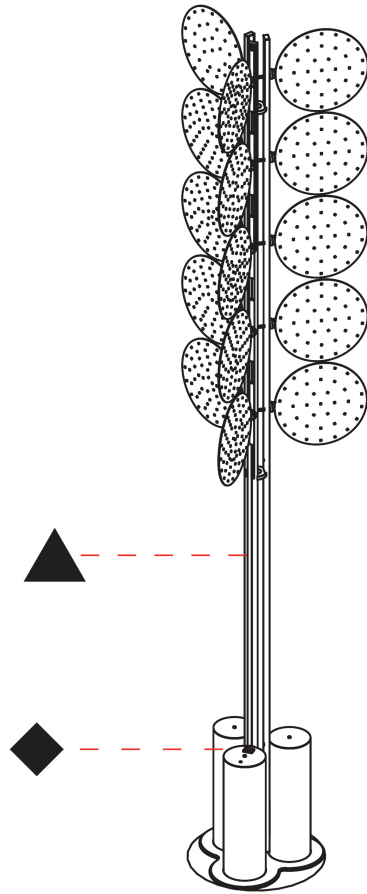

A

BEACON GRID PORTABLE

A340012-

base number Finishes (Diamond) Finishes (Triangle)

- To build a product code in our configurator select the specify button on the base model # product page
- To build a manual product code on this datasheet choose from the options listed below in blue font and add the suffix to the base model #

GENERAL

Series: Code
 Subseries: Beacon Grid
 Brand: Prolicht
 Division: Architectural
 Mounting Type: Portable
 Mounting Location: Floor
 Subcategory: Ambient

PHYSICAL

Shape: Abstract
 Diameter (mm): 485
 Diameter (in): 19 1/8
 Height (mm): 2020
 Height (in): 79 1/2
 Light Distribution: Omnidirectional
 Fixture Finish: SSR / BKV / CWI / CRY / HAB / UFT / ITA / RUA / FTG / MYG / LOD / PUS / FRO / FUP / KIA / POP / BLS / SPG / MEY / GOH / GUM / CHC / COM / ABZ / JAG / OBR / MOS / ROR
 Fixture Material: Aluminum

ELECTRICAL

Lamp Type: LED (Zhaga Standard)
 Input Wattage (W): 62.7
 Total Output Wattage (W): 57.3
 Dimming: Non-Dimmable
 Driver Included: Yes
 Driver Location: Integrated
 Driver Type: Constant Current - Universal
 Driver Class: Class 2
 Input Voltage (V): 120 - 277
 Constant Current (MA): 79

LED

Color Temperature (°K): 2700
 Max. Delivered Lumen (lm): 6900
 Nominal Lumen (lm): 6900
 CRI: >90 CRI
 Lamp Life (hrs): 50000

OPTICAL

Beam Angle: 122

RATINGS AND CERTIFICATIONS

Certified By: CSA Certified to UL and CSA Standards
 IP rating: IP20

PROJECT
TYPE
SPECIFIER
QUANTITY
DATE

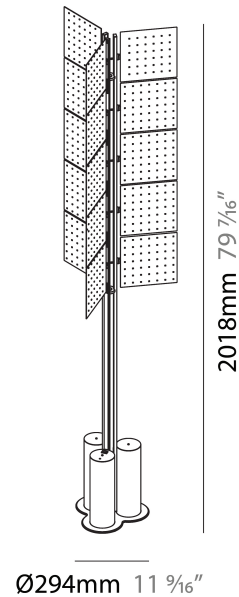

BEACON GRID PORTABLE

A340012-

PROJECT _____

TYPE _____

SPECIFIER _____

QUANTITY _____

DATE _____

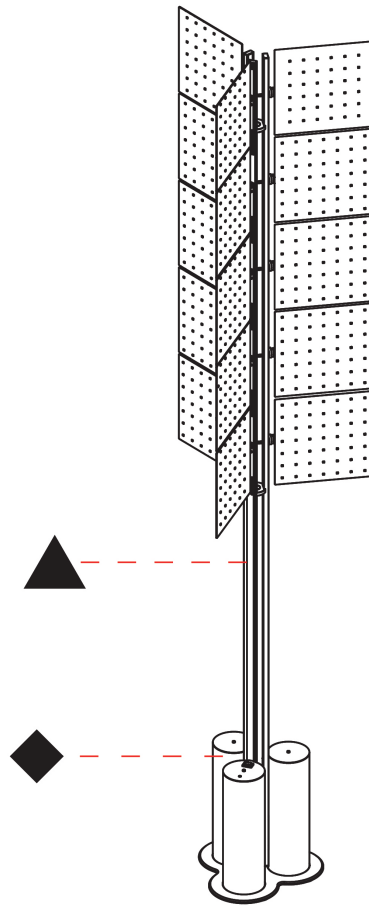

A

SCREEN DOT PORTABLE

A340013- -

base number Finishes (Diamond) Finishes (Triangle)

- To build a product code in our configurator select the specify button on the base model # product page
- To build a manual product code on this datasheet choose from the options listed below in blue font and add the suffix to the base model #

GENERAL

Series: Code
 Subseries: Screen Dot
 Brand: Prolicht
 Division: Architectural
 Mounting Type: Portable
 Mounting Location: Floor
 Subcategory: Ambient

PHYSICAL

Shape: Abstract
 Length (mm): 1100
 Length (in): 43 ⁵/₁₆
 Width (mm): 650
 Width (in): 43 ⁵/₁₆
 Height (mm): 2020
 Height (in): 79 ¹/₂
 Light Distribution: Direct
 Fixture Finish: SSR / BKV / CWI / CRY / HAB / UFT / ITA / RUA / FTG / MYG / LOD / PUS / FRO / FUP / KIA / POP / BLS / SPG / MEY / GOH / GUM / CHC / COM / ABZ / JAG / OBR / MOS / ROR
 Fixture Material: Aluminum

ELECTRICAL

Lamp Type: LED (Zhaga Standard)
 Input Wattage (W): 146.3
 Total Output Wattage (W): 132.7
 Dimming: Non-Dimmable
 Driver Included: Yes
 Driver Location: Integrated
 Driver Type: Constant Current - Universal
 Driver Class: Class 2
 Input Voltage (V): 120 - 277
 Constant Current (MA): 79

LED

Color Temperature (°K): 2700
 Max. Delivered Lumen (lm): 15750
 Nominal Lumen (lm): 15750
 CRI: >90 CRI
 Lamp Life (hrs): 50000

OPTICAL

Beam Angle: 122

RATINGS AND CERTIFICATIONS

Certified By: CSA Certified to UL and CSA Standards
 IP rating: IP20

PROJECT
TYPE
SPECIFIER
QUANTITY
DATE

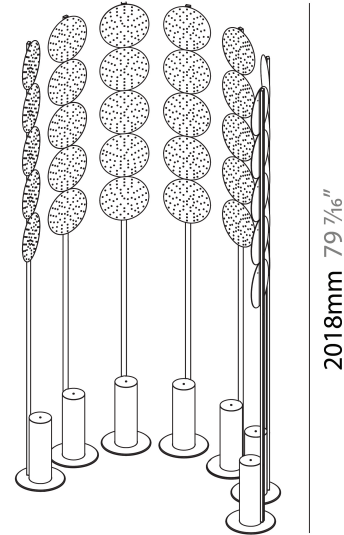

SCREEN DOT PORTABLE

A340013-

PROJECT _____

TYPE _____

SPECIFIER _____

QUANTITY _____

DATE _____

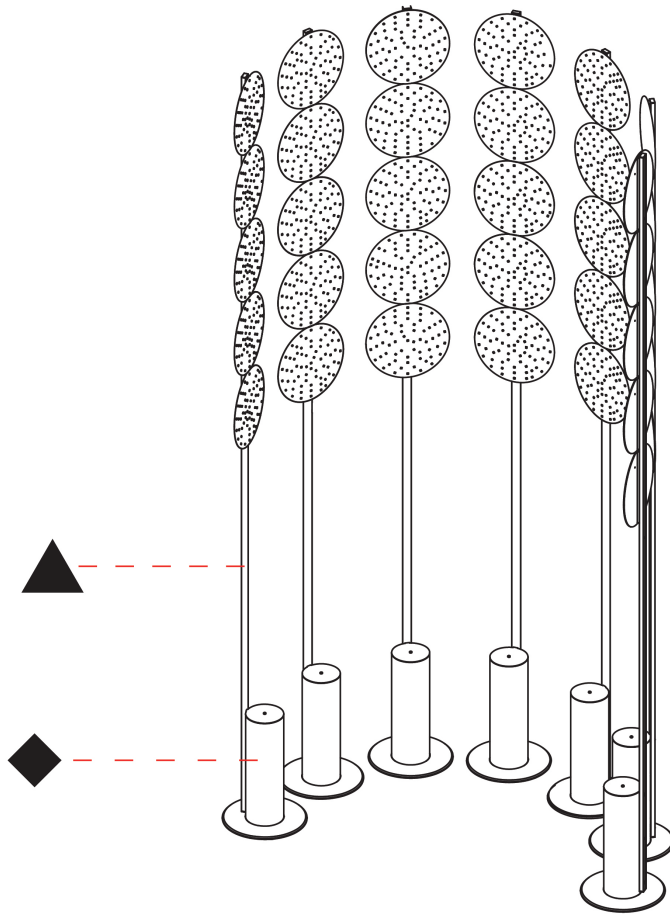

SCREEN GRID PORTABLE

A340014- -

base number Finishes (Diamond) Finishes (Triangle)

- To build a product code in our configurator select the specify button on the base model # product page
- To build a manual product code on this datasheet choose from the options listed below in blue font and add the suffix to the base model #

GENERAL

Series: Code
 Subseries: Screen Grid
 Brand: Prolicht
 Division: Architectural
 Mounting Type: Portable
 Mounting Location: Floor
 Subcategory: Ambient

PHYSICAL

Shape: Abstract
 Length (mm): 1100
 Length (in): 43 ⁵/₁₆
 Width (mm): 650
 Width (in): 43 ⁵/₁₆
 Height (mm): 2020
 Height (in): 79 ¹/₂
 Light Distribution: Direct
 Weight (kg): 31.244

Fixture Finish: SSR / BKV / CWI / CRY / HAB / UFT / ITA / RUA / FTG / MYG / LOD / PUS / FRO / FUP / KIA / POP / BLS / SPG / MEY / GOH / GUM / CHC / COM / ABZ / JAG / OBR / MOS / ROR

Fixture Material: Aluminum

ELECTRICAL

Lamp Type: LED (Zhaga Standard)
 Input Wattage (W): 146.3
 Total Output Wattage (W): 132.7
 Dimming: Non-Dimmable
 Driver Included: Yes
 Driver Location: Integrated
 Driver Type: Constant Current - Universal
 Driver Class: Class 2
 Input Voltage (V): 120 - 277
 Constant Current (MA): 79

LED

Color Temperature (°K): 2700
 Max. Delivered Lumen (lm): 16100
 Nominal Lumen (lm): 16100
 CRI: >90 CRI
 Lamp Life (hrs): 50000

OPTICAL

Beam Angle: 122

RATINGS AND CERTIFICATIONS

Certified By: CSA Certified to UL and CSA Standards
 IP rating: IP20

PROJECT
TYPE
SPECIFIER
QUANTITY
DATE

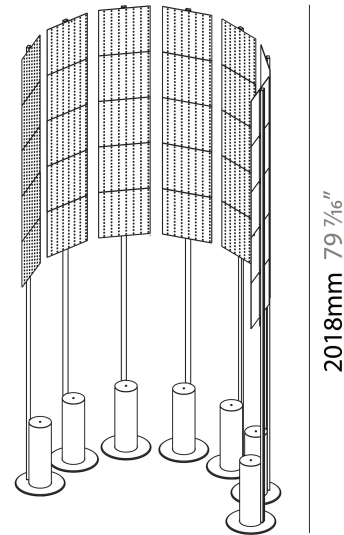

SCREEN GRID PORTABLE

A340014-

PROJECT _____

TYPE _____

SPECIFIER _____

QUANTITY _____

DATE _____

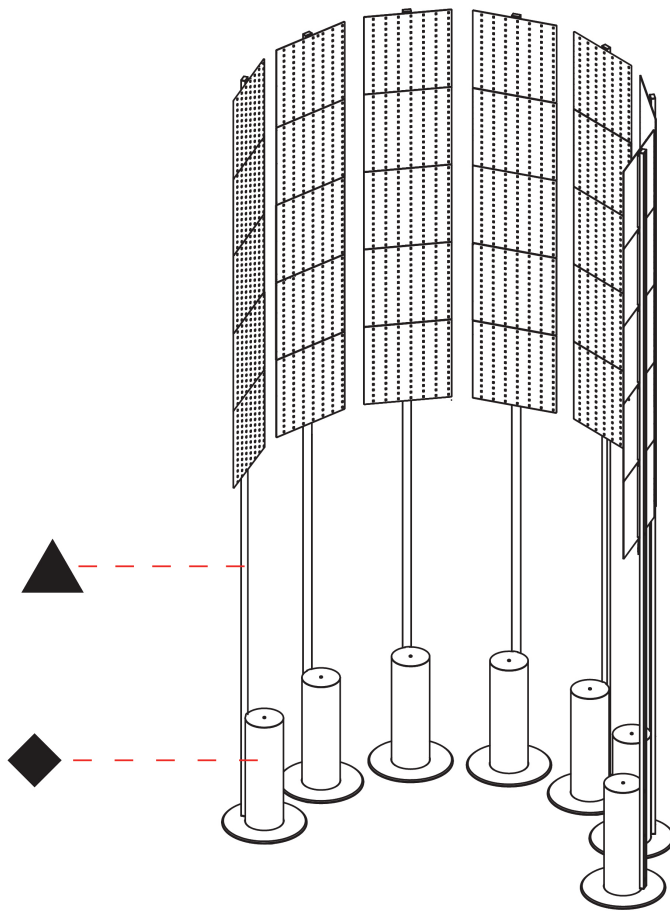

A

PROJECT
TYPE
SPECIFIER
QUANTITY
DATE

CODE COLOR FINISH CHART

Fixture Finish



Digital: Not all screens are calibrated the same, and therefore, colors will appear differently between screens.

Physical: When texture is involved, there will be variations in color, character and tone within a product series and between product families.

Gun Metal: No Gun Metal finish is alike. It combines a mixture of transparent and black color particles which ensures a highly individual effect and no luminaire being identical.

Champagne Cream, Copper Mine, Ancient Bronze + Jazz Gold: These finishes have slight fading from specific powder coating production. Each luminaire will slightly vary.



PROJECT
TYPE
SPECIFIER
QUANTITY
DATE











LEGEND

 floor-mounted	 pivotable	 special LED (upon request) RGB, RGBW, tunable, gold+, meat+, art+, fashion+
 wall and ceiling: recessed and surface mounted	 rotating	 warm dim / natural dimming LED
 ceiling-mounted and wall-mounted	 illuminate tilted	 rechargeable battery powered
 wall-mounted	 color of suspension cable	 fixture with natural vivid LED (upon request)
 omni-directional light distribution	 length of suspension cable	 color rendering index
 direct light distribution	 reflector degree selection	 color temperature
 direct/indirect light distribution	 super spot	 lumen (luminous flux)
 indirect light distribution	 lens	 efficacy (lumens per watt)
 asymmetric light distribution	 lens pack	 Unified Glare Rating (UGR) range from 5-40
 aura light distribution	 shine ring	 marine grade (AISI 316 stainless steel)
 round wall or ceiling cut-out	 integrated shine ring with diffuser	 walk on
 square wall or ceiling cut-out	 free individual colors 01-29	 drive on
 the supplied jig specifies the cutout dimensions	 individual colors: 00 (free of charge), 01-25 (extra charge)	 Dark Sky Compliance
 minimum distance (meters) lamp - object	 luminaire part to be colored (F1)	 Americans with Disabilities Act (less than 4" off the wall located between 27"-84" from floor)
 recessed depth	 luminaire part to be colored (F2)	 lamp protected against explosion
 ceiling thickness in mm	 luminaire part to be colored (F3)	 blown glass using traditional methods by master glass blower
 ceiling thickness selection	 luminaire part to be colored (F4)	 acoustic material
 dimmable DP (phase), DV (0-10V), DD (dali), DS (step-dim)	 luminaire part to be colored (F5)	 protection class I, protection insulation
 included or excluded LED driver/transformer/control gear	 color of 3-circuit adaptor	 protection class II, protection insulation
 separately switchable	 indirect diffuser	 ETL Certified to UL and CSA Standards
 sensor	 direct diffuser	 UL Certified to UL and CSA Standards
 remote control	 ball-proof (upon request)	 CSA Certified to UL and CSA Standards
 available upon request	 accessory	 Certified for North American Standards

IP RATING

 IP20	protected against ingress of solid bodies greater than 12.5mm (finger)
 IP33	protected against ingress of solid bodies greater than 2.5mm protected against sprays of water up to 60 degrees from the vertical (rain)
 IP40	protected against ingress of solid bodies greater than 1mm (wire) no protection against the ingress of moisture
 IP43	protected against ingress of solid bodies greater than 1mm (wire) protected against sprays of water up to 60 degrees from the vertical (rain)
 IP44	protected against ingress of solid bodies greater than 1mm (wire) protected against water splashed from all directions
 IP54	protected against limited ingress of dust (wet rooms/covered outdoor areas) protected against water splashed from all directions
 IP65	protected against ingress of dust protected against jets of water
 IP66	protected against ingress of dust protected against powerful jets of water or heavy seas
 IP67	protected against ingress of dust protected against immersion of water between 15cm - 1m for 30 minutes
 IP68	protected against ingress of dust protected against immersion of water under pressure for long periods

IK RATING

 IK01	protected against 0.14 joules impact (equivalent to 0.25kg mass dropped from 56mm above the surface)
 IK02	protected against 0.2 joules impact (equivalent to 0.25kg mass dropped from 80mm above the surface)
 IK03	protected against 0.35 joules impact (equivalent to 0.25kg mass dropped from 140mm above the surface)
 IK04	protected against 0.5 joules impact (equivalent to 0.25kg mass dropped from 200mm above the surface)
 IK05	protected against 0.7 joules impact (equivalent to 0.25kg mass dropped from 280mm above the surface)
 IK06	protected against 1 joules impact (equivalent to 0.25kg mass dropped from 400mm above the surface)
 IK07	protected against 2 joules impact (equivalent to 0.5kg mass dropped from 400mm above the surface)
 IK08	protected against 5 joules impact (equivalent to 1.7kg mass dropped from 300mm above the surface)
 IK09	protected against 10 joules impact (equivalent to 5.0kg mass dropped from 200mm above the surface)
 IK10	protected against 20 joules impact (equivalent to 5.0kg mass dropped from 400mm above the surface)