

TOTEM DOT PORTABLE

A340010- -

base number Finishes (Diamond) Finishes (Triangle)

- To build a product code in our configurator select the specify button on the base model # product page
- To build a manual product code on this datasheet choose from the options listed below in blue font and add the suffix to the base model #

GENERAL

Series: Code _____
 Subseries: Totem Dot _____
 Brand: Prolicht _____
 Division: Architectural _____
 Mounting Type: Portable _____
 Mounting Location: Floor _____
 Subcategory: Ambient _____

PHYSICAL

Shape: Abstract _____
 Diameter (mm): 300 _____
 Diameter (in): 11 ¹³/₁₆ _____
 Height (mm): 2100 _____
 Height (in): 82 ¹¹/₁₆ _____
 Light Distribution: Omnidirectional _____
 Fixture Finish: SSR / BKV / CWI / CRY / HAB / UFT / ITA / RUA / FTG / MYG / LOD / PUS / FRO / FUP / KIA / POP / BLS / SPG / MEY / GOH / GUM / CHC / COM / ABZ / JAG / OBR / MOS / ROR _____
 Fixture Material: Aluminum _____

ELECTRICAL

Lamp Type: LED (Zhaga Standard) _____
 Input Wattage (W): 163 _____
 Total Output Wattage (W): 148.2 _____
 Dimming: Non-Dimmable _____
 Driver Included: Yes _____
 Driver Location: Integrated _____
 Driver Type: Constant Current - Universal _____
 Driver Class: Class 2 _____
 Input Voltage (V): 120 - 277 _____
 Constant Current (MA): 79 _____

LED

Color Temperature (°K): 2700 _____
 Max. Delivered Lumen (lm): 17550 _____
 Nominal Lumen (lm): 17550 _____
 CRI: >90 CRI _____
 Lamp Life (hrs): 50000 _____

OPTICAL

Beam Angle: 122 _____

RATINGS AND CERTIFICATIONS

Certified By: CSA Certified to UL and CSA Standards _____
 IP rating: IP20 _____

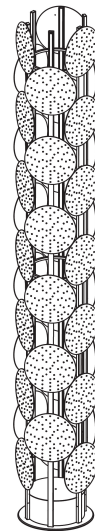

2077mm 81 3/4"

Ø290mm 11 7/16"



TOTEM DOT PORTABLE

A340010-

PROJECT _____

TYPE _____

SPECIFIER _____

QUANTITY _____

DATE _____



A

BEACON DOT PORTABLE

A340011-

base number Finishes (Diamond) Finishes (Triangle)

- To build a product code in our configurator select the specify button on the base model # product page
- To build a manual product code on this datasheet choose from the options listed below in blue font and add the suffix to the base model #

GENERAL

Series: Code
 Subseries: Beacon Dot
 Brand: Prolicht
 Division: Architectural
 Mounting Type: Portable
 Mounting Location: Floor
 Subcategory: Ambient

PHYSICAL

Shape: Abstract
 Diameter (mm): 485
 Diameter (in): 19 1/8
 Height (mm): 2020
 Height (in): 79 1/2
 Light Distribution: Omnidirectional
 Fixture Finish: SSR / BKV / CWI / CRY / HAB / UFT / ITA / RUA / FTG / MYG / LOD / PUS / FRO / FUP / KIA / POP / BLS / SPG / MEY / GOH / GUM / CHC / COM / ABZ / JAG / OBR / MOS / ROR
 Fixture Material: Aluminum

ELECTRICAL

Lamp Type: LED (Zhaga Standard)
 Input Wattage (W): 62.7
 Total Output Wattage (W): 57.3
 Dimming: Non-Dimmable
 Driver Included: Yes
 Driver Location: Integrated
 Driver Type: Constant Current - Universal
 Driver Class: Class 2
 Input Voltage (V): 120 - 277
 Constant Current (MA): 79

LED

Color Temperature (°K): 2700
 Max. Delivered Lumen (lm): 6750
 Nominal Lumen (lm): 675
 CRI: >90 CRI
 Lamp Life (hrs): 50000

OPTICAL

Beam Angle: 122

RATINGS AND CERTIFICATIONS

Certified By: CSA Certified to UL and CSA Standards
 IP rating: IP20

PROJECT
TYPE
SPECIFIER
QUANTITY
DATE

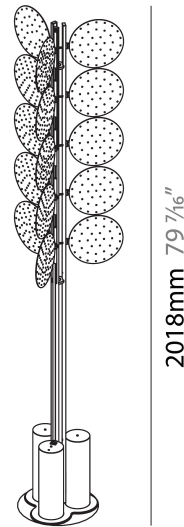
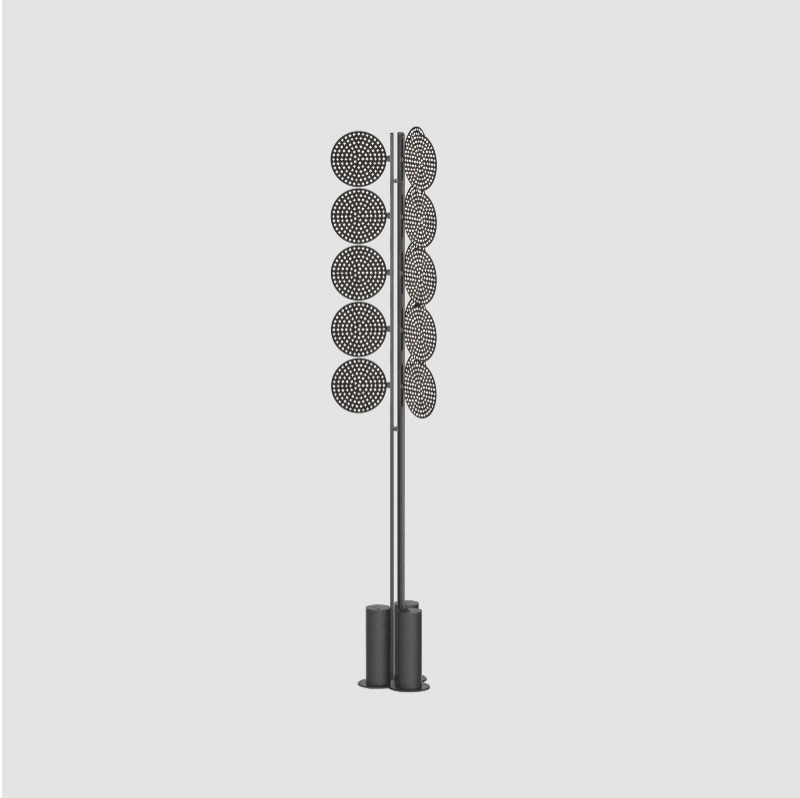

Ø294mm 11 9/16"



BEACON DOT PORTABLE

A340011-

PROJECT

TYPE

SPECIFIER

QUANTITY

DATE

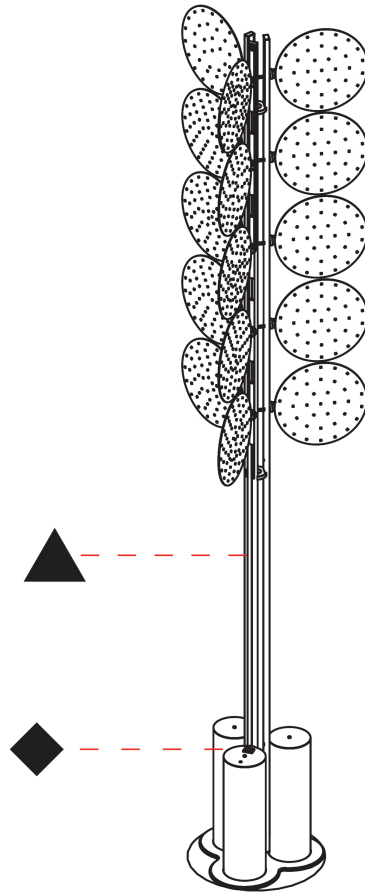

A

BEACON GRID PORTABLE

A340012- -

base number Finishes (Diamond) Finishes (Triangle)

- To build a product code in our configurator select the specify button on the base model # product page
- To build a manual product code on this datasheet choose from the options listed below in blue font and add the suffix to the base model #

GENERAL

Series: Code _____
 Subseries: Beacon Grid _____
 Brand: Prolicht _____
 Division: Architectural _____
 Mounting Type: Portable _____
 Mounting Location: Floor _____
 Subcategory: Ambient _____

PHYSICAL

Shape: Abstract _____
 Diameter (mm): 485 _____
 Diameter (in): 19 1/8 _____
 Height (mm): 2020 _____
 Height (in): 79 1/2 _____
 Light Distribution: Omnidirectional _____
 Fixture Finish: SSR / BKV / CWI / CRY / HAB / UFT / ITA / RUA / FTG / MYG / LOD / PUS / FRO / FUP / KIA / POP / BLS / SPG / MEY / GOH / GUM / CHC / COM / ABZ / JAG / OBR / MOS / ROR _____
 Fixture Material: Aluminum _____

ELECTRICAL

Lamp Type: LED (Zhaga Standard) _____
 Input Wattage (W): 62.7 _____
 Total Output Wattage (W): 57.3 _____
 Dimming: Non-Dimmable _____
 Driver Included: Yes _____
 Driver Location: Integrated _____
 Driver Type: Constant Current - Universal _____
 Driver Class: Class 2 _____
 Input Voltage (V): 120 - 277 _____
 Constant Current (MA): 79 _____

LED

Color Temperature (°K): 2700 _____
 Max. Delivered Lumen (lm): 6900 _____
 Nominal Lumen (lm): 6900 _____
 CRI: >90 CRI _____
 Lamp Life (hrs): 50000 _____

OPTICAL

Beam Angle: 122 _____

RATINGS AND CERTIFICATIONS

Certified By: CSA Certified to UL and CSA Standards _____
 IP rating: IP20 _____

PROJECT
TYPE
SPECIFIER
QUANTITY
DATE

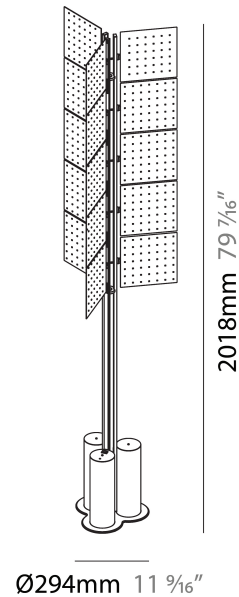

BEACON GRID PORTABLE

A340012-

PROJECT _____

TYPE _____

SPECIFIER _____

QUANTITY _____

DATE _____

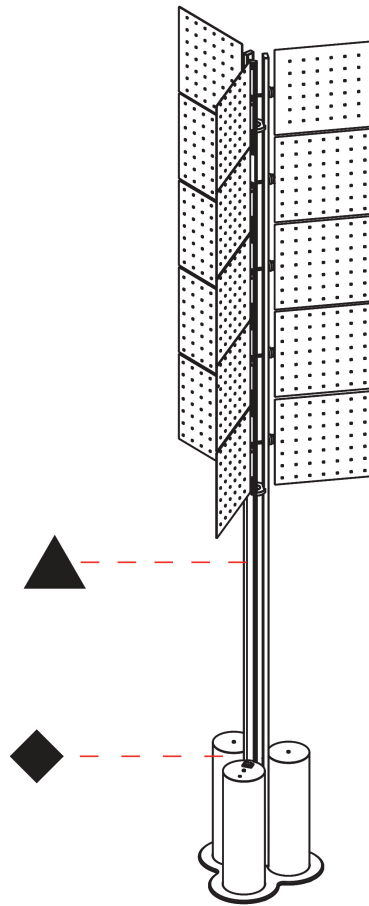

A

SCREEN DOT PORTABLE

A340013- -

base number Finishes (Diamond) Finishes (Triangle)

- To build a product code in our configurator select the specify button on the base model # product page
- To build a manual product code on this datasheet choose from the options listed below in blue font and add the suffix to the base model #

GENERAL

Series: Code _____
 Subseries: Screen Dot _____
 Brand: Prolicht _____
 Division: Architectural _____
 Mounting Type: Portable _____
 Mounting Location: Floor _____
 Subcategory: Ambient _____

PHYSICAL

Shape: Abstract _____
 Length (mm): 1100 _____
 Length (in): 43 ⁵/₁₆ _____
 Width (mm): 650 _____
 Width (in): 43 ⁵/₁₆ _____
 Height (mm): 2020 _____
 Height (in): 79 ¹/₂ _____
 Light Distribution: Direct _____
 Fixture Finish: SSR / BKV / CWI / CRY / HAB / UFT / ITA / RUA / FTG / MYG / LOD / PUS / FRO / FUP / KIA / POP / BLS / SPG / MEY / GOH / GUM / CHC / COM / ABZ / JAG / OBR / MOS / ROR _____
 Fixture Material: Aluminum _____

ELECTRICAL

Lamp Type: LED (Zhaga Standard) _____
 Input Wattage (W): 146.3 _____
 Total Output Wattage (W): 132.7 _____
 Dimming: Non-Dimmable _____
 Driver Included: Yes _____
 Driver Location: Integrated _____
 Driver Type: Constant Current - Universal _____
 Driver Class: Class 2 _____
 Input Voltage (V): 120 - 277 _____
 Constant Current (MA): 79 _____

LED

Color Temperature (°K): 2700 _____
 Max. Delivered Lumen (lm): 15750 _____
 Nominal Lumen (lm): 15750 _____
 CRI: >90 CRI _____
 Lamp Life (hrs): 50000 _____

OPTICAL

Beam Angle: 122 _____

RATINGS AND CERTIFICATIONS

Certified By: CSA Certified to UL and CSA Standards _____
 IP rating: IP20 _____

PROJECT	_____
TYPE	_____
SPECIFIER	_____
QUANTITY	_____
DATE	_____

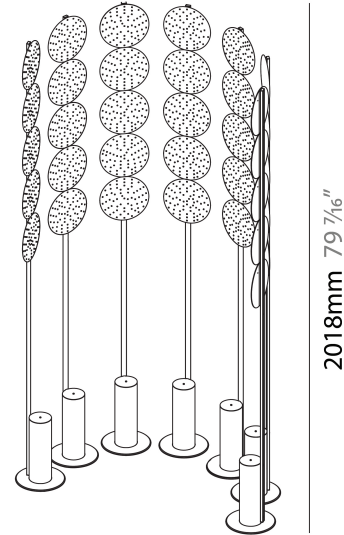

SCREEN DOT PORTABLE

A340013-

PROJECT _____

TYPE _____

SPECIFIER _____

QUANTITY _____

DATE _____

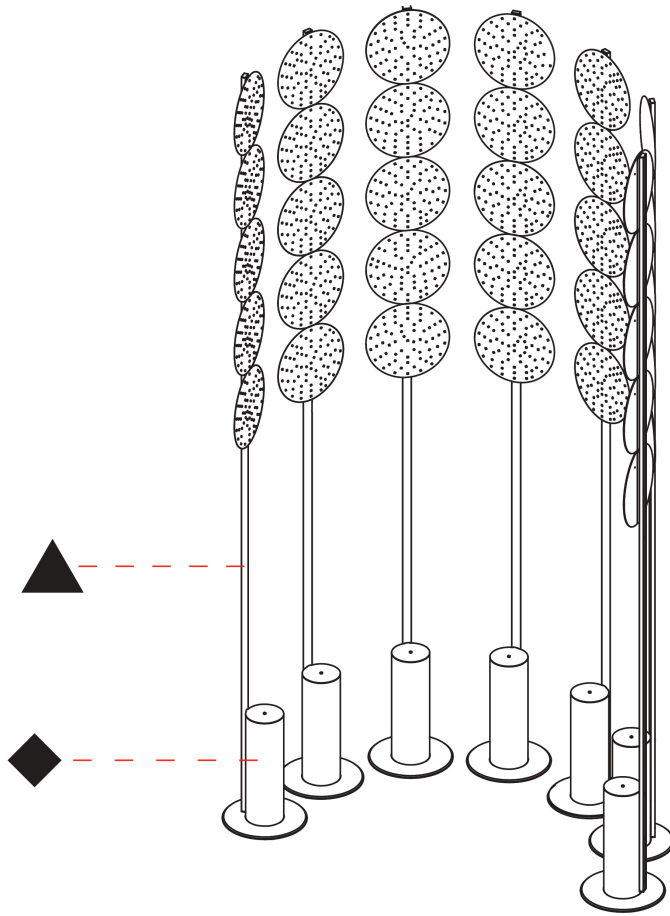

A

SCREEN GRID PORTABLE

A340014- -

base number Finishes (Diamond) Finishes (Triangle)

- To build a product code in our configurator select the specify button on the base model # product page
- To build a manual product code on this datasheet choose from the options listed below in blue font and add the suffix to the base model #

GENERAL

Series: Code
 Subseries: Screen Grid
 Brand: Prolicht
 Division: Architectural
 Mounting Type: Portable
 Mounting Location: Floor
 Subcategory: Ambient

PHYSICAL

Shape: Abstract
 Length (mm): 1100
 Length (in): 43 ⁵/₁₆
 Width (mm): 650
 Width (in): 43 ⁵/₁₆
 Height (mm): 2020
 Height (in): 79 ¹/₂
 Light Distribution: Direct
 Weight (kg): 31.244

Fixture Finish: SSR / BKV / CWI / CRY / HAB / UFT / ITA / RUA / FTG / MYG / LOD / PUS / FRO / FUP / KIA / POP / BLS / SPG / MEY / GOH / GUM / CHC / COM / ABZ / JAG / OBR / MOS / ROR

Fixture Material: Aluminum

ELECTRICAL

Lamp Type: LED (Zhaga Standard)
 Input Wattage (W): 146.3
 Total Output Wattage (W): 132.7
 Dimming: Non-Dimmable
 Driver Included: Yes
 Driver Location: Integrated
 Driver Type: Constant Current - Universal
 Driver Class: Class 2
 Input Voltage (V): 120 - 277
 Constant Current (MA): 79

LED

Color Temperature (°K): 2700
 Max. Delivered Lumen (lm): 16100
 Nominal Lumen (lm): 16100
 CRI: >90 CRI
 Lamp Life (hrs): 50000

OPTICAL

Beam Angle: 122

RATINGS AND CERTIFICATIONS

Certified By: CSA Certified to UL and CSA Standards
 IP rating: IP20

PROJECT
TYPE
SPECIFIER
QUANTITY
DATE

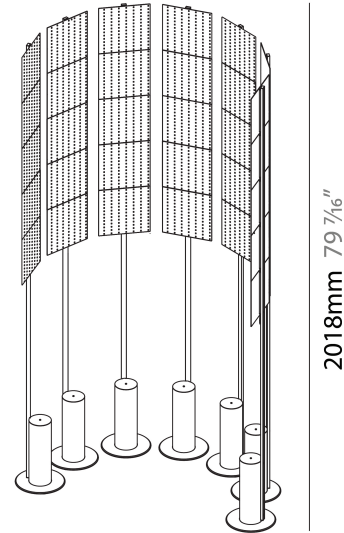

SCREEN GRID PORTABLE

A340014-

PROJECT _____

TYPE _____

SPECIFIER _____

QUANTITY _____

DATE _____

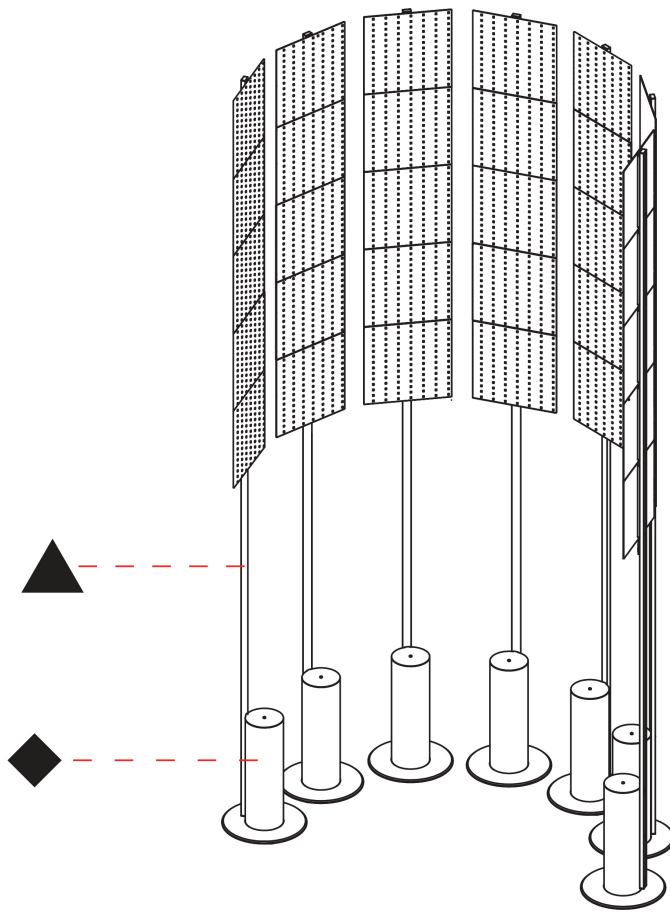

A

EXPLOSION DOT SURFACE

A3D244-

base number LED Finishes Finishes
 Dimming (Diamond) (Triangle)

- To build a product code in our configurator select the specify button on the base model # product page
- To build a manual product code on this datasheet choose from the options listed below in blue font and add the suffix to the base model #

GENERAL

Series: Code _____
 Subseries: Explosion Dot _____
 Brand: Prolicht _____
 Division: Architectural _____
 Mounting Type: Surface _____
 Mounting Location: Wall / Ceiling _____
 Subcategory: Ambient _____

PHYSICAL

Shape: Abstract _____
 Diameter (mm): 2605 _____
 Diameter (in): 102 ⁹/₁₆ _____
 Depth (mm): 185 _____
 Depth (in): 7 ³/₁₆ _____
 Light Distribution: Direct _____
 Fixture Finish: SSR / BKV / CWI / CRY / HAB / UFT / ITA / RUA / FTG / MYG / LOD / PUS / FRO / FUP / KIA / POP / BLS / SPG / MEY / GOH / GUM / CHC / COM / ABZ / JAG / OBR / MOS / ROR _____
 Fixture Material: Aluminum _____

ELECTRICAL

Lamp Type: LED (Zhaga Standard) _____
 Input Wattage (W): 227.7 _____
 Total Output Wattage (W): 174.5 _____
 Dimming: [Non-Dimming](#) / [DALI Dimming](#) _____
 Driver Included: Yes _____
 Driver Location: Integrated _____
 Driver Type: Constant Current - Universal _____
 Driver Class: Class 2 _____
 Input Voltage (V): 120 - 277 _____
 Constant Current (MA): 79 _____

LED

Color Temperature (°K): 2700 _____
 Max. Delivered Lumen (lm): 20700 _____
 Nominal Lumen (lm): 20700 _____
 CRI: >90 CRI _____
 Lamp Life (hrs): 50000 _____

OPTICAL

Beam Angle: 122 _____

RATINGS AND CERTIFICATIONS

Certified By: CSA Certified to UL and CSA Standards _____
 IP rating: IP20 _____

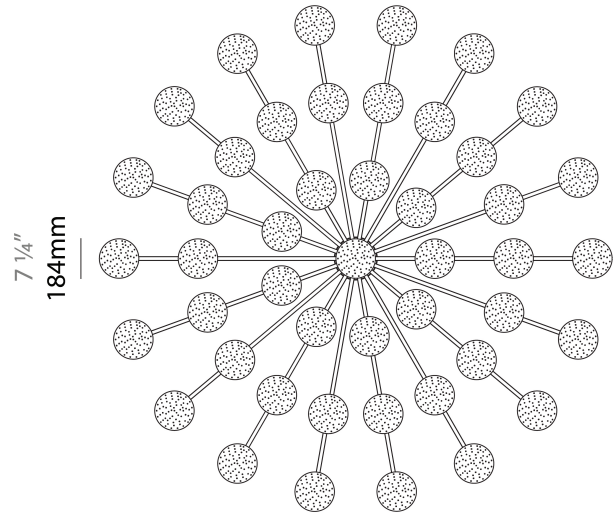
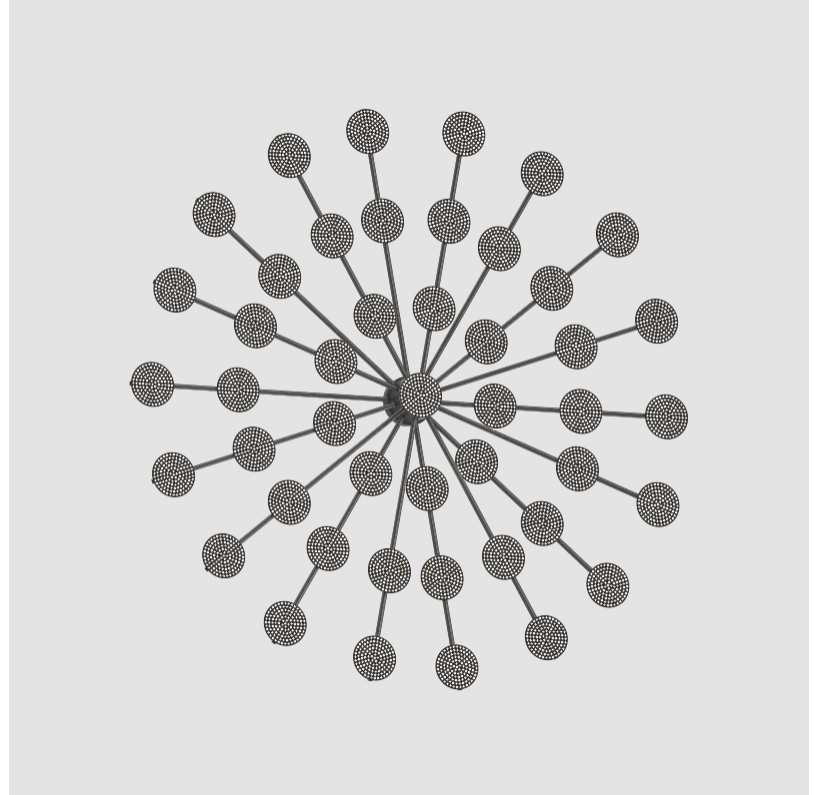

EXPLOSION DOT SURFACE

A3D244-

PROJECT

TYPE

SPECIFIER

QUANTITY

DATE

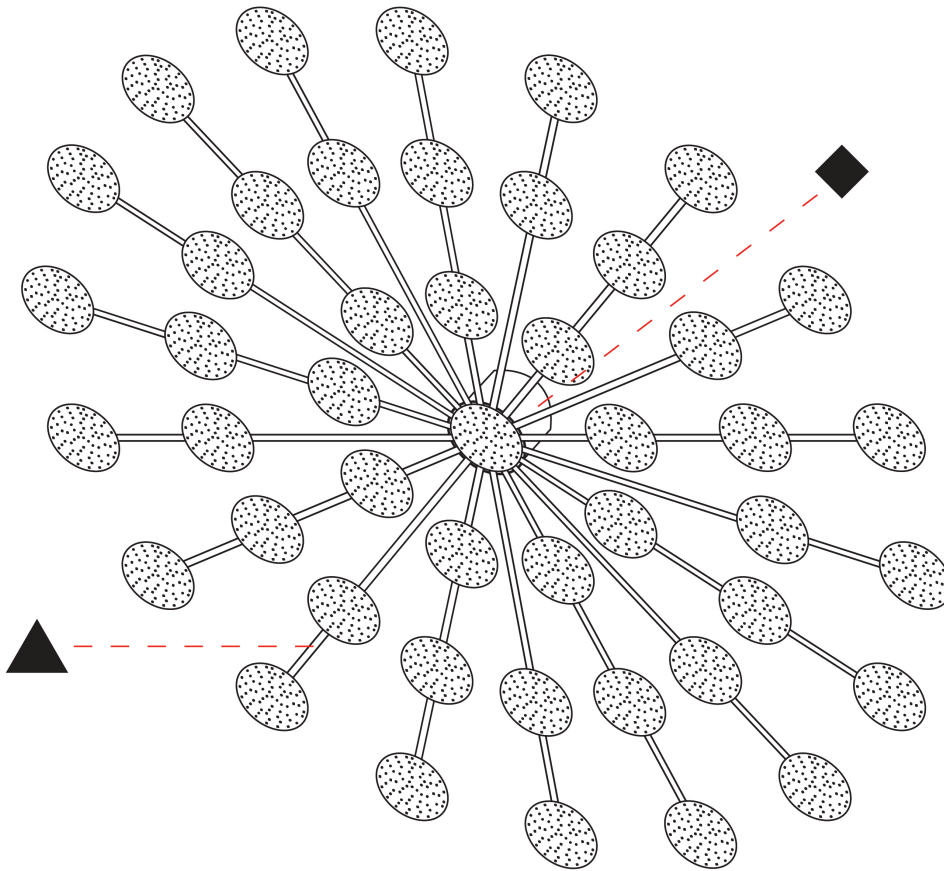

A

PROJECT _____
 TYPE _____
 SPECIFIER _____
 QUANTITY _____
 DATE _____

EXPLOSION DOT SURFACE

A3D245-

base number	LED Dimming	Finishes (Diamond)	Finishes (Triangle)	Finishes (Circle)
-------------	-------------	--------------------	---------------------	-------------------

- To build a product code in our configurator select the specify button on the base model # product page
- To build a manual product code on this datasheet choose from the options listed below in blue font and add the suffix to the base model #

GENERAL

Series: Code
Subseries: Explosion Dot
Brand: Prolicht
Division: Architectural
Mounting Type: Surface
Mounting Location: Wall / Ceiling
Subcategory: Ambient

PHYSICAL

Shape: Abstract
Diameter (mm): 2605
Diameter (in): 102 ⁹ / ₁₆
Depth (mm): 185
Depth (in): 7 ³ / ₁₆
Light Distribution: Indirect
Fixture Finish: SSR / BKV / CWI / CRY / HAB / UFT / ITA / RUA / FTG / MYG / LOD / PUS / FRO / FUP / KIA / POP / BLS / SPG / MEY / GOH / GUM / CHC / COM / ABZ / JAG / OBR / MOS / ROR
Fixture Material: Aluminum

ELECTRICAL

Lamp Type: LED (Zhaga Standard)
Input Wattage (W): 227.7
Total Output Wattage (W): 207.3
Dimming: Non-Dimming / DALI Dimming
Driver Included: Yes
Driver Location: Integrated
Driver Type: Constant Current - Universal
Driver Class: Class 2
Input Voltage (V): 120 - 277
Constant Current (MA): 96

LED

Color Temperature (°K): 2700
Max. Delivered Lumen (lm): 18000
Nominal Lumen (lm): 18000
CRI: >90 CRI
Lamp Life (hrs): 50000

OPTICAL

Beam Angle: 180

RATINGS AND CERTIFICATIONS

Certified By: CSA Certified to UL and CSA Standards
IP rating: IP20

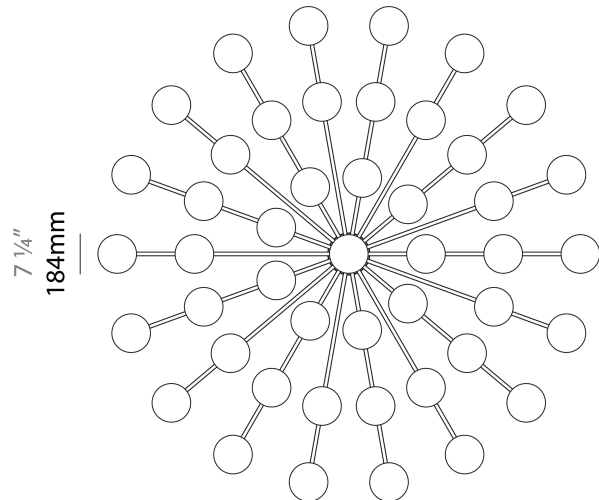
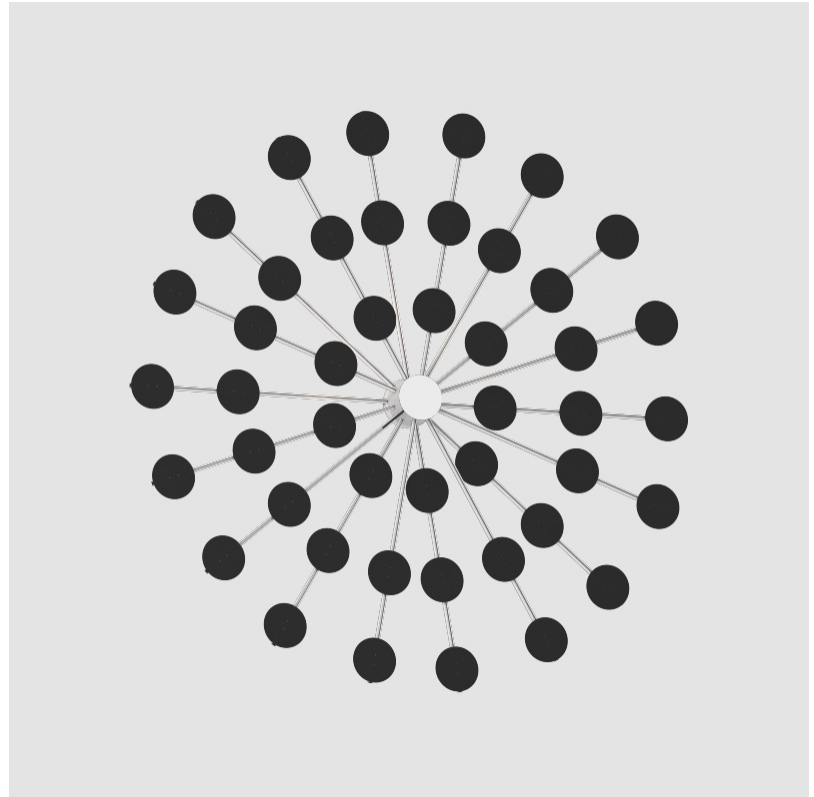

EXPLOSION DOT SURFACE

A3D245-

PROJECT	_____
TYPE	_____
SPECIFIER	_____
QUANTITY	_____
DATE	_____

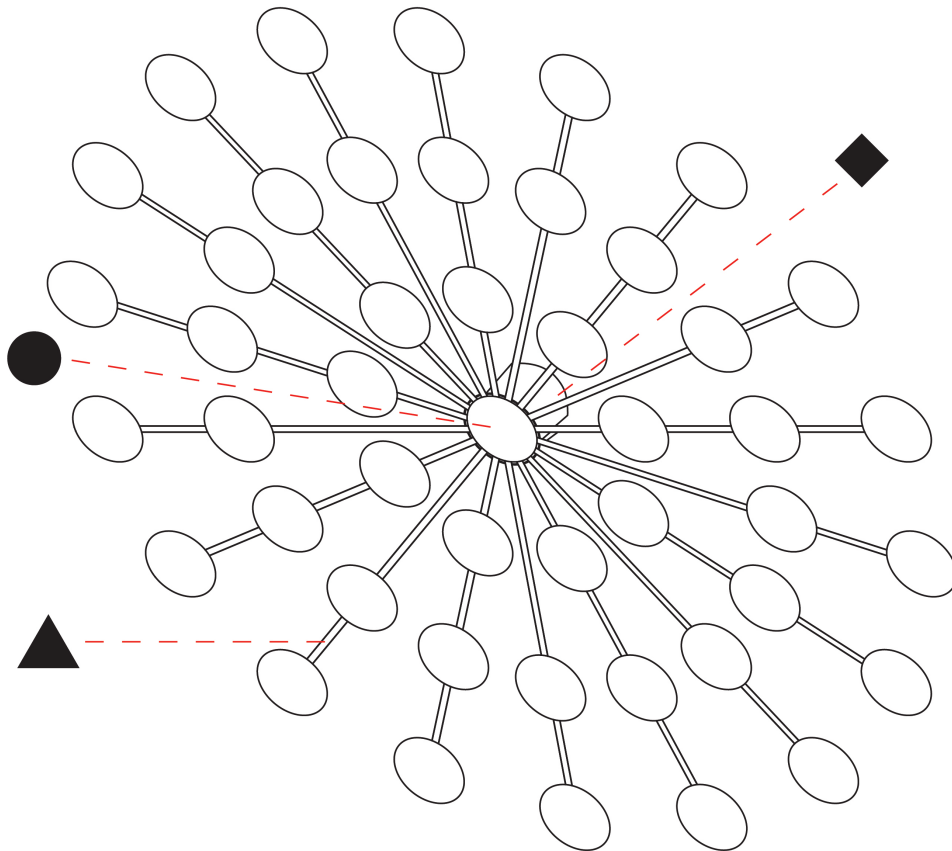

A

PROJECT
TYPE
SPECIFIER
QUANTITY
DATE

CODE COLOR FINISH CHART

Fixture Finish



Digital: Not all screens are calibrated the same, and therefore, colors will appear differently between screens.

Physical: When texture is involved, there will be variations in color, character and tone within a product series and between product families.

Gun Metal: No Gun Metal finish is alike. It combines a mixture of transparent and black color particles which ensures a highly individual effect and no luminaire being identical.

Champagne Cream, Copper Mine, Ancient Bronze + Jazz Gold: These finishes have slight fading from specific powder coating production. Each luminaire will slightly vary.



PROJECT	
TYPE	
SPECIFIER	
QUANTITY	
DATE	

LEGEND

floor-mounted	pivotal	special LED (upon request) RGB, RGBW, tunable, gold+, meat+, art+, fashion+
wall and ceiling: recessed and surface mounted	rotating	warm dim / natural dimming LED
ceiling-mounted and wall-mounted	illuminate tilted	rechargeable battery powered
wall-mounted	color of suspension cable	fixture with natural vivid LED (upon request)
omni-directional light distribution	length of suspension cable	color rendering index
direct light distribution	reflector degree selection	color temperature
direct/indirect light distribution	super spot	lumen (luminous flux)
indirect light distribution	lens	efficacy (lumens per watt)
asymmetric light distribution	lens pack	Unified Glare Rating (UGR) range from 5-40
aura light distribution	shine ring	marine grade (AISI 316 stainless steel)
round wall or ceiling cut-out	integrated shine ring with diffuser	walk on
square wall or ceiling cut-out	free individual colors 01-29	drive on
the supplied jig specifies the cutout dimensions	individual colors: 00 (free of charge), 01-25 (extra charge)	Dark Sky Compliance
minimum distance (meters) lamp - object	luminaire part to be colored (F1)	Americans with Disabilities Act (less than 4" off the wall located between 27"-84" from floor)
recessed depth	luminaire part to be colored (F2)	lamp protected against explosion
ceiling thickness in mm	luminaire part to be colored (F3)	blown glass using traditional methods by master glass blower
ceiling thickness selection	luminaire part to be colored (F4)	acoustic material
dimmable DP (phase), DV (0-10V), DD (dali), DS (step-dim)	luminaire part to be colored (F5)	protection class I, protection insulation
included or excluded LED driver/transformer/control gear	color of 3-circuit adaptor	protection class II, protection insulation
separately switchable	indirect diffuser	ETL Certified to UL and CSA Standards
sensor	direct diffuser	UL Certified to UL and CSA Standards
remote control	ball-proof (upon request)	CSA Certified to UL and CSA Standards
available upon request	accessory	Certified for North American Standards

IP RATING

IP20	protected against ingress of solid bodies greater than 12.5mm (finger)
IP33	protected against ingress of solid bodies greater than 2.5mm protected against sprays of water up to 60 degrees from the vertical (rain)
IP40	protected against ingress of solid bodies greater than 1mm (wire) no protection against the ingress of moisture
IP43	protected against ingress of solid bodies greater than 1mm (wire) protected against sprays of water up to 60 degrees from the vertical (rain)
IP44	protected against ingress of solid bodies greater than 1mm (wire) protected against water splashed from all directions
IP54	protected against limited ingress of dust (wet rooms/covered outdoor areas) protected against water splashed from all directions
IP65	protected against ingress of dust protected against jets of water
IP66	protected against ingress of dust protected against powerful jets of water or heavy seas
IP67	protected against ingress of dust protected against immersion of water between 15cm - 1m for 30 minutes
IP68	protected against ingress of dust protected against immersion of water under pressure for long periods

IK RATING

IK01	protected against 0.14 joules impact (equivalent to 0.25kg mass dropped from 56mm above the surface)
IK02	protected against 0.2 joules impact (equivalent to 0.25kg mass dropped from 80mm above the surface)
IK03	protected against 0.35 joules impact (equivalent to 0.25kg mass dropped from 140mm above the surface)
IK04	protected against 0.5 joules impact (equivalent to 0.25kg mass dropped from 200mm above the surface)
IK05	protected against 0.7 joules impact (equivalent to 0.25kg mass dropped from 280mm above the surface)
IK06	protected against 1 joules impact (equivalent to 0.25kg mass dropped from 400mm above the surface)
IK07	protected against 2 joules impact (equivalent to 0.5kg mass dropped from 400mm above the surface)
IK08	protected against 5 joules impact (equivalent to 1.7kg mass dropped from 300mm above the surface)
IK09	protected against 10 joules impact (equivalent to 5.0kg mass dropped from 200mm above the surface)
IK10	protected against 20 joules impact (equivalent to 5.0kg mass dropped from 400mm above the surface)