

CONFORT RECTANGLE SUSPENSION

D41042-

base number Finish
Options

PROJECT	_____
TYPE	_____
SPECIFIER	_____
QUANTITY	_____
DATE	_____

- To build a product code in our configurator select the specify button on the base model # product page
- To build a manual product code on this datasheet choose from the options listed below in blue font and add the suffix to the base model #

GENERAL

Series: Confort _____
 Subseries: Confort Rectangle _____
 Partner: Icone _____
 Division: Design _____
 Installation: Suspension _____
 Product Type: Pendant _____
 Mounting Location: Ceiling _____
 Light Distribution: Direct _____

PHYSICAL

Shape: Rectangle _____
 Length (mm): 970 _____
 Length (in): 38 ⁷/₁₆ _____
 Width (mm): 200 _____
 Width (in): 7 ⁷/₈ _____
 Max. Overall Height (mm): 1500 _____
 Max. Overall Height (in): 59 ⁷/₁₆ _____
 Fixture Finish: WAM / WAN / WGF / WCL / WPW / BKA / BAN / BGL / BCL / BPW _____
 Fixture Material: Aluminum _____

ELECTRICAL

Lamp Type: LED _____
 Total Output Wattage (W): 60.5 _____
 Dimming: Electronic Low Voltage Dimming _____
 Input Voltage (V): 120Vac Direct Line _____

LED

Number of LEDs: 9+1 _____
 Color Temperature (°K): 3000 _____
 Nominal Lumen (lm): Dir 3150 / Ind 1700 _____
 CRI: >90 CRI _____
 Lamp Life (hrs): 50000 _____

OPTICAL

RATINGS AND CERTIFICATIONS

Certified By: Certified for North American Standards _____
 IP rating: IP20 _____

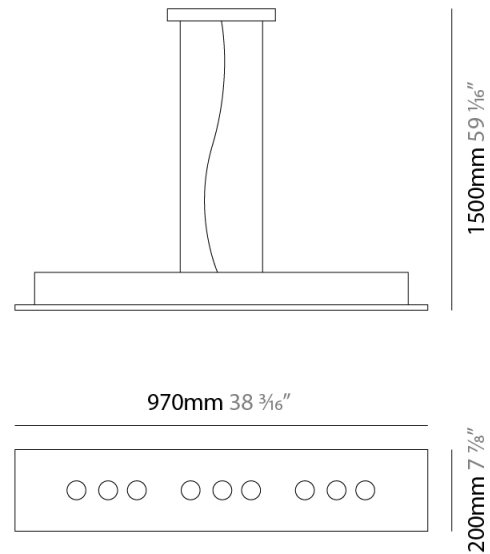

CONFORT RECTANGLE SUSPENSION

D41042-

PROJECT	_____
TYPE	_____
SPECIFIER	_____
QUANTITY	_____
DATE	_____

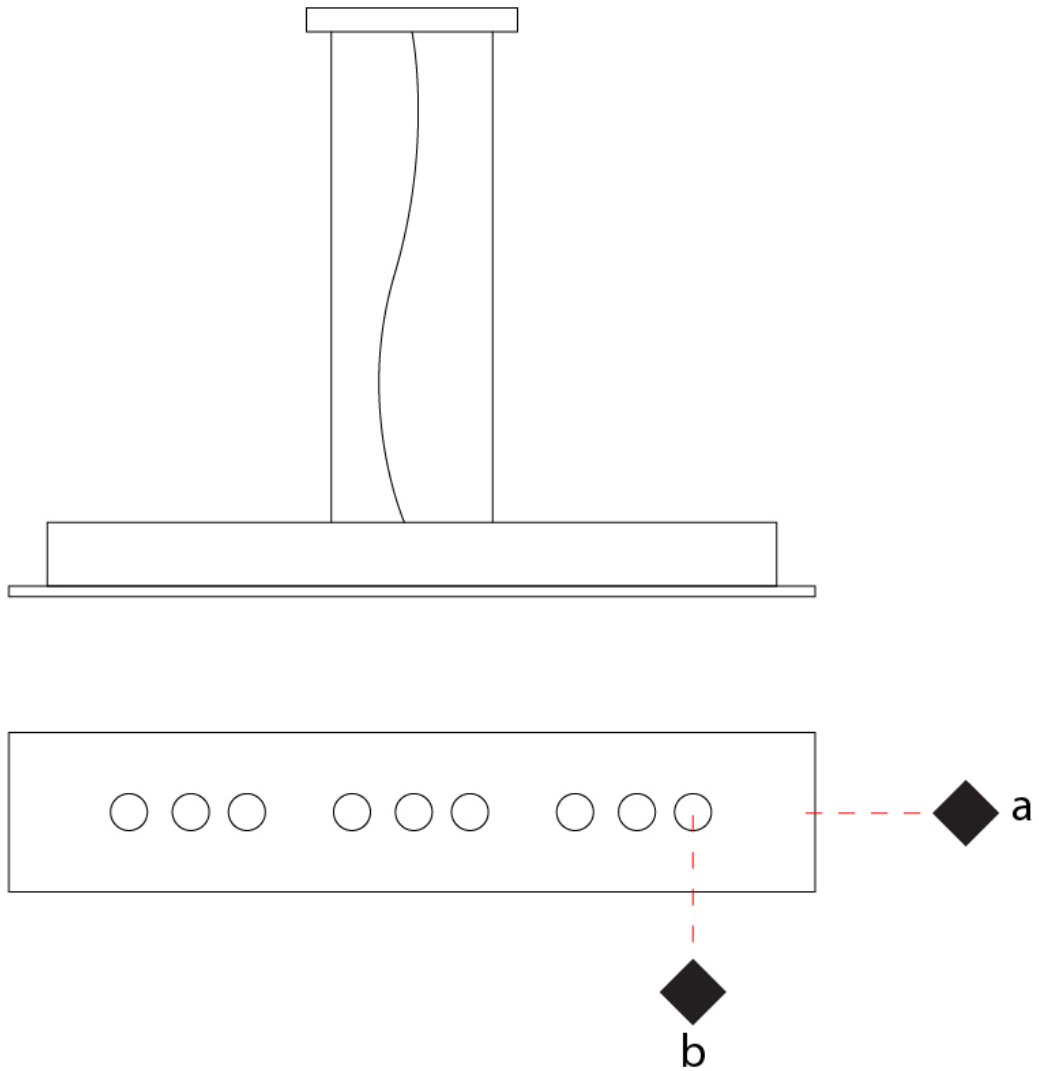

D

PROJECT	_____
TYPE	_____
SPECIFIER	_____
QUANTITY	_____
DATE	_____

CONFORT SQUARE SUSPENSION

D41043-

base number _____
 Finish _____
 Options _____

- To build a product code in our configurator select the specify button on the base model # product page
- To build a manual product code on this datasheet choose from the options listed below in blue font and add the suffix to the base model #

GENERAL

Series: Confort _____
 Subseries: Confort Square _____
 Partner: Icone _____
 Division: Design _____
 Installation: Suspension _____
 Product Type: Pendant _____
 Mounting Location: Ceiling _____
 Light Distribution: Direct _____

PHYSICAL

Shape: Square _____
 Length (mm): 650 _____
 Length (in): 25 ⁹/₁₆ _____
 Width (mm): 650 _____
 Width (in): 25 ⁹/₁₆ _____
 Max. Overall Height (mm): 1500 _____
 Max. Overall Height (in): 59 ⁷/₁₆ _____
 Fixture Finish: WAM / WAN / WGF / WCL / WPW / BKA / BAN / BGL / BCL / BPW _____
 Fixture Material: Aluminum _____

ELECTRICAL

Lamp Type: LED _____
 Total Output Wattage (W): 54 _____
 Dimming: Electronic Low Voltage Dimming _____
 Input Voltage (V): 120Vac Direct Line _____

LED

Number of LEDs: 12 _____
 Color Temperature (°K): 3000 _____
 Nominal Lumen (lm): 4200 _____
 CRI: >90 CRI _____
 Lamp Life (hrs): 50000 _____

OPTICAL

RATINGS AND CERTIFICATIONS

Certified By: Certified for North American Standards _____
 IP rating: IP20 _____

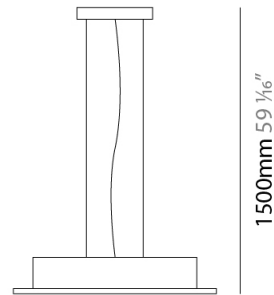
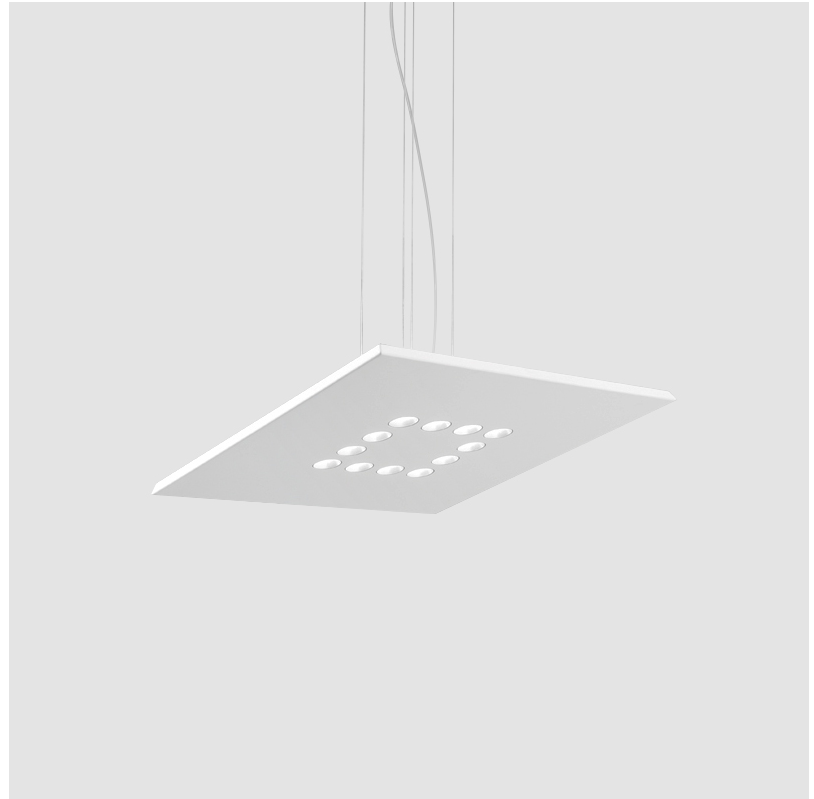

650mm 25 9/16 inches

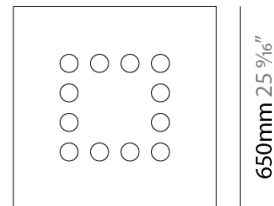

CONFORT SQUARE SUSPENSION

D41043-

PROJECT _____

TYPE _____

SPECIFIER _____

QUANTITY _____

DATE _____

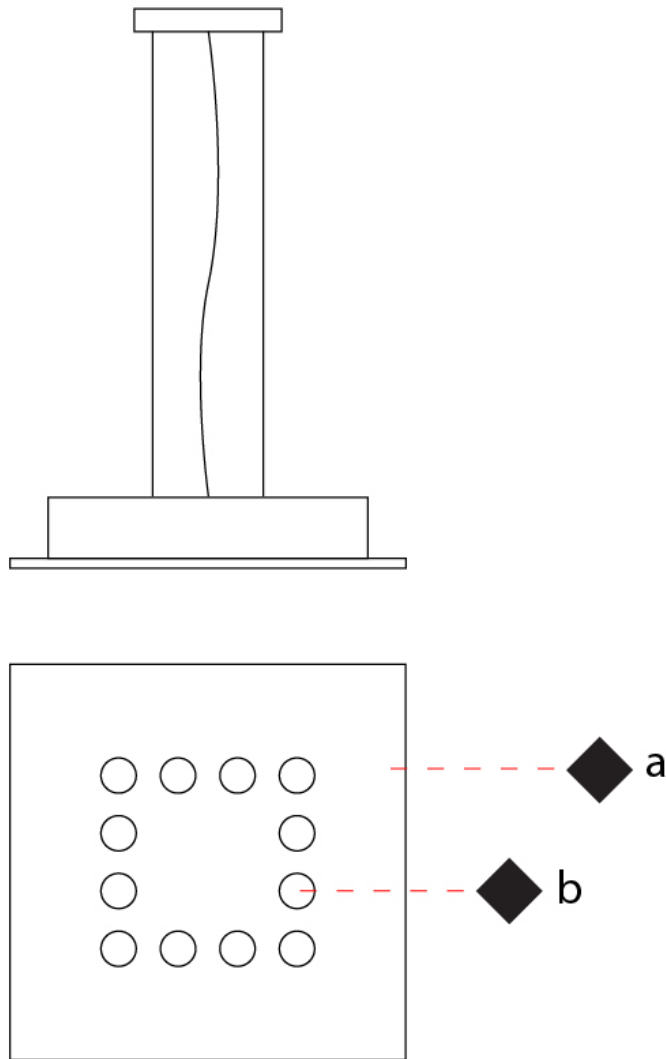

D

PROJECT	_____
TYPE	_____
SPECIFIER	_____
QUANTITY	_____
DATE	_____

CONFORT SQUARE SUSPENSION

D41044-

base number _____
 Finish _____
 Options _____

- To build a product code in our configurator select the specify button on the base model # product page
- To build a manual product code on this datasheet choose from the options listed below in blue font and add the suffix to the base model #

GENERAL

Series: Confort _____
 Subseries: Confort Square _____
 Partner: Icone _____
 Division: Design _____
 Installation: Suspension _____
 Product Type: Pendant _____
 Mounting Location: Ceiling _____
 Light Distribution: Direct _____

PHYSICAL

Shape: Square _____
 Length (mm): 650 _____
 Length (in): 25 ⁹/₁₆ _____
 Width (mm): 650 _____
 Width (in): 25 ⁹/₁₆ _____
 Max. Overall Height (mm): 1500 _____
 Max. Overall Height (in): 59 ⁷/₁₆ _____
 Fixture Finish: WAM / WAN / WGF / WCL / WPW / BKA / BAN / BGL / BCL / BPW _____
 Fixture Material: Aluminum _____

ELECTRICAL

Lamp Type: LED _____
 Total Output Wattage (W): 74 _____
 Dimming: Electronic Low Voltage Dimming _____
 Input Voltage (V): 120Vac Direct Line _____

LED

Number of LEDs: 12+1 _____
 Color Temperature (°K): 3000 _____
 Nominal Lumen (lm): Dir 4200 / Ind 1700 _____
 CRI: >90 CRI _____
 Lamp Life (hrs): 50000 _____

OPTICAL

RATINGS AND CERTIFICATIONS

Certified By: Certified for North American Standards _____
 IP rating: IP20 _____

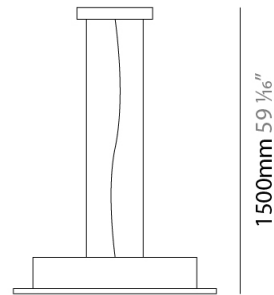
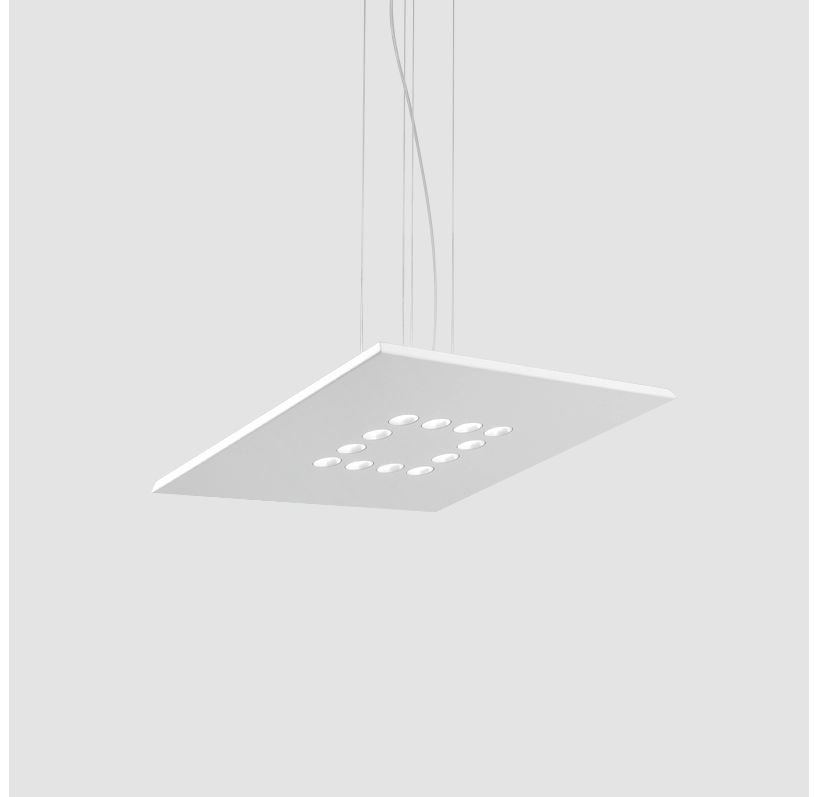

650mm 25 9/16"

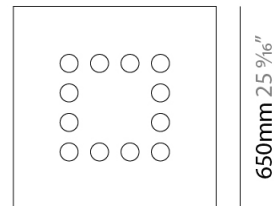

CONFORT SQUARE SUSPENSION

D41044-

PROJECT

TYPE

SPECIFIER

QUANTITY

DATE

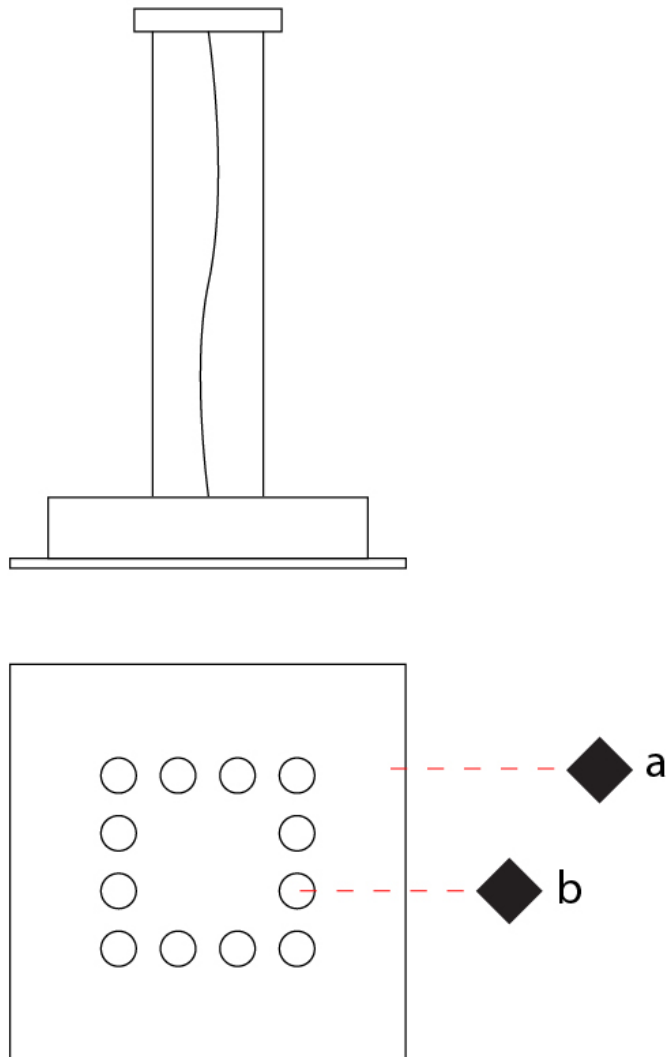

D

CONFORT RECTANGLE SUSPENSION

D41045-

base number Finish
Options

PROJECT	_____
TYPE	_____
SPECIFIER	_____
QUANTITY	_____
DATE	_____

- To build a product code in our configurator select the specify button on the base model # product page
- To build a manual product code on this datasheet choose from the options listed below in blue font and add the suffix to the base model #

GENERAL

Series: Confort _____
 Subseries: Confort Rectangle _____
 Partner: Icone _____
 Division: Design _____
 Installation: Suspension _____
 Product Type: Pendant _____
 Mounting Location: Ceiling _____
 Light Distribution: Direct _____

PHYSICAL

Shape: Rectangle _____
 Length (mm): 970 _____
 Length (in): 38 ⁷/₁₆ _____
 Width (mm): 200 _____
 Width (in): 7 ⁷/₈ _____
 Max. Overall Height (mm): 1500 _____
 Max. Overall Height (in): 59 ¹/₁₆ _____
 Fixture Finish: WAM / WAN / WGF / WCL / WPW / BKA / BAN / BGL / BCL / BPW _____
 Fixture Material: Aluminum _____

ELECTRICAL

Lamp Type: LED _____
 Total Output Wattage (W): 40.5 _____
 Dimming: Electronic Low Voltage Dimming _____
 Input Voltage (V): 120Vac Direct Line _____

LED

Number of LEDs: 8 _____
 Color Temperature (°K): 3000 _____
 Nominal Lumen (lm): 3150 _____
 CRI: >90 CRI _____
 Lamp Life (hrs): 50000 _____

OPTICAL

RATINGS AND CERTIFICATIONS

Certified By: Certified for North American Standards _____
 IP rating: IP20 _____

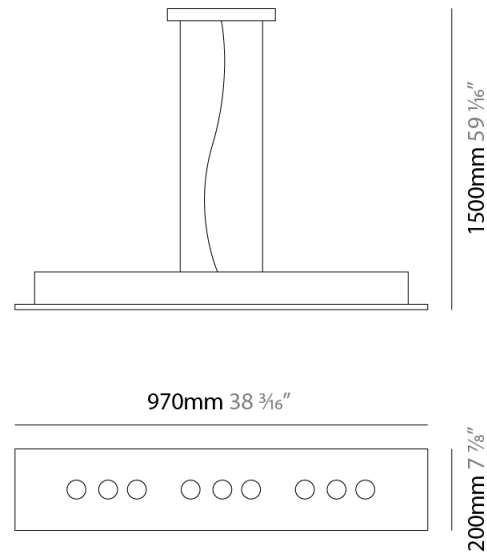

CONFORT RECTANGLE SUSPENSION

D41045-

PROJECT	_____
TYPE	_____
SPECIFIER	_____
QUANTITY	_____
DATE	_____

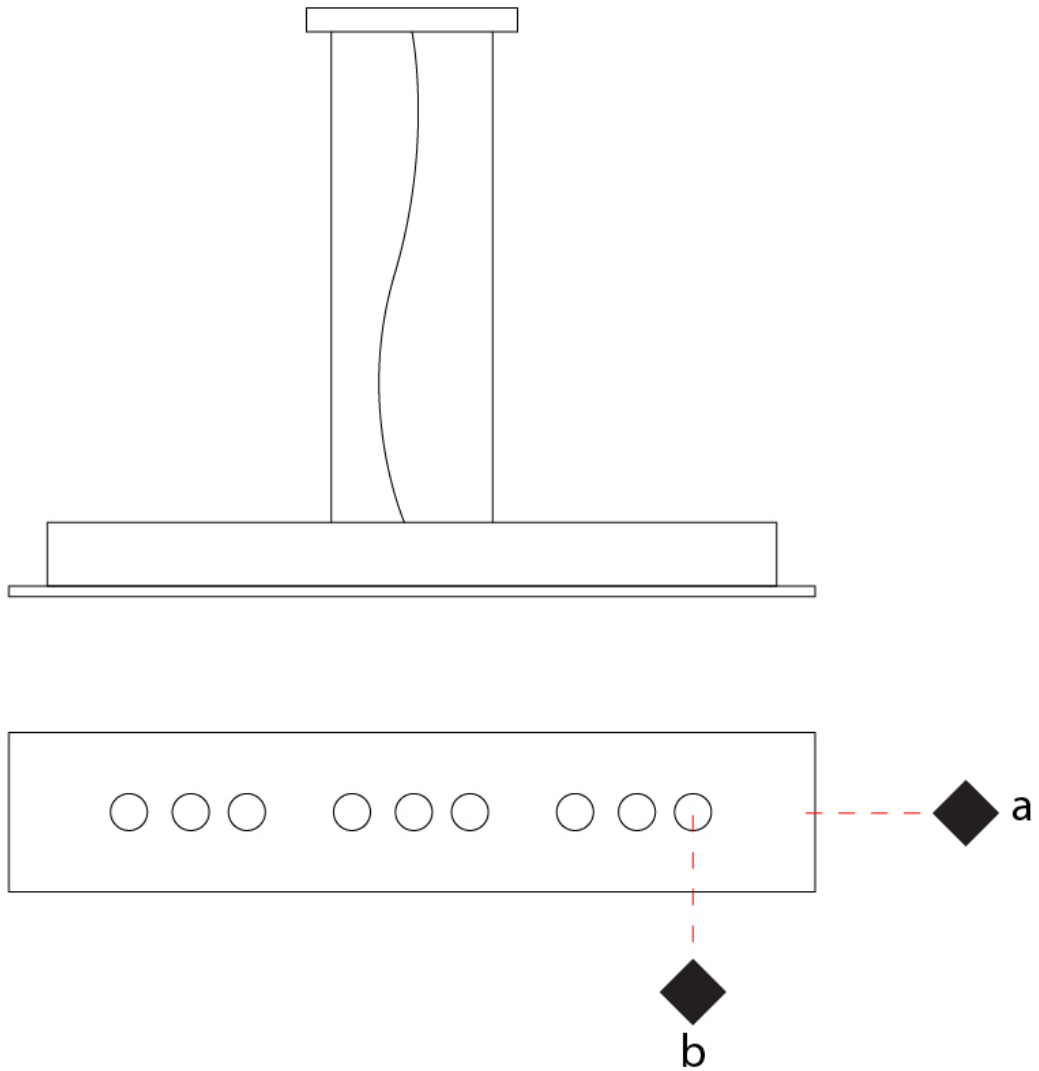

D

PROJECT
TYPE
SPECIFIER
QUANTITY
DATE

CONFORT RECTANGLE SURFACE

D42056-

base number Finish
Options

- To build a product code in our configurator select the specify button on the base model # product page
- To build a manual product code on this datasheet choose from the options listed below in blue font and add the suffix to the base model #

GENERAL

Series: Confort
 Subseries: Confort Rectangle
 Partner: Icone
 Division: Design
 Installation: Surface
 Product Type: Ceiling Surface
 Mounting Location: Ceiling
 Light Distribution: Direct

PHYSICAL

Shape: Rectangle
 Length (mm): 970
 Length (in): 38 ⁷/₁₆
 Width (mm): 200
 Width (in): 7 ⁷/₈
 Fixture Finish: WAM / WAN / WGF / WCL / WPW / BKA / BAN / BGL / BCL / BPW
 Fixture Material: Aluminum

ELECTRICAL

Lamp Type: LED
 Total Output Wattage (W): 13.5
 Dimming: Electronic Low Voltage Dimming
 Input Voltage (V): 120Vac Direct Line

LED

Number of LEDs: 3
 Color Temperature (°K): 3000
 Nominal Lumen (lm): 1050
 CRI: >90 CRI
 Lamp Life (hrs): 50000

OPTICAL

RATINGS AND CERTIFICATIONS

Certified By: Certified for North American Standards
 IP rating: IP20

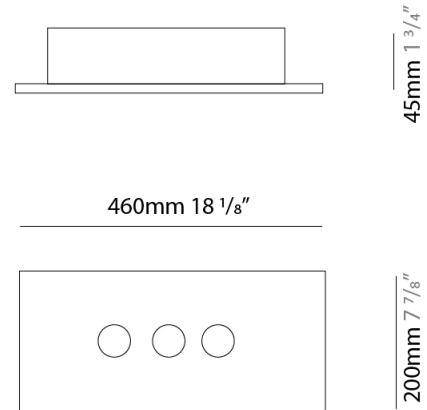
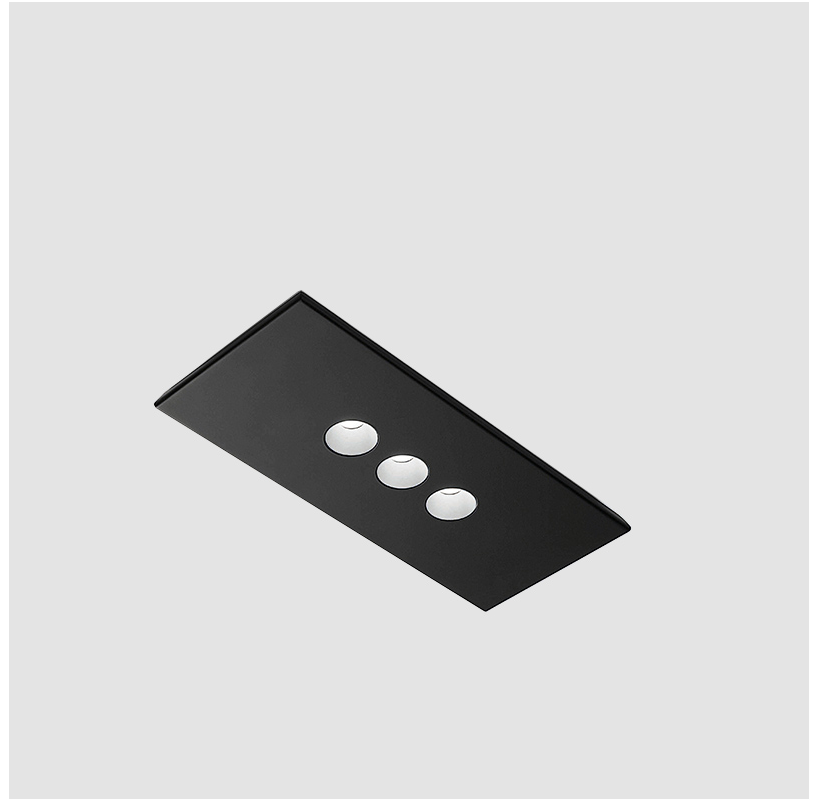

CONFORT RECTANGLE SURFACE

D42056-

PROJECT	_____
TYPE	_____
SPECIFIER	_____
QUANTITY	_____
DATE	_____

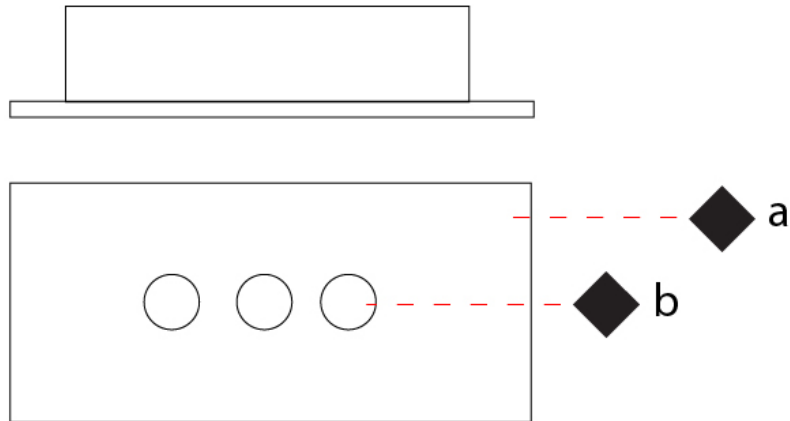

CONFORT SQUARE SURFACE

D42057-

base number Finish
Options

- To build a product code in our configurator select the specify button on the base model # product page
- To build a manual product code on this datasheet choose from the options listed below in blue font and add the suffix to the base model #

GENERAL

Series: Confort
Subseries: Confort Square
Partner: Icone
Division: Design
Installation: Surface
Product Type: Ceiling Surface
Mounting Location: Ceiling
Light Distribution: Direct

PHYSICAL

Shape: Square
Length (mm): 380
Length (in): 14 ¹⁵/₁₆
Width (mm): 380
Width (in): 14 ¹⁵/₁₆
Fixture Finish: WAM / WAN / WGF / WCL / WPW / BKA / BAN / BGL / BCL / BPW
Fixture Material: Aluminum

ELECTRICAL

Lamp Type: LED
Total Output Wattage (W): 18
Dimming: Electronic Low Voltage Dimming
Input Voltage (V): 120Vac Direct Line

LED

Number of LEDs: 4
Color Temperature (°K): 3000
Nominal Lumen (lm): 1575
CRI: >90 CRI
Lamp Life (hrs): 50000

OPTICAL

RATINGS AND CERTIFICATIONS

Certified By: Certified for North American Standards
IP rating: IP20

PROJECT	_____
TYPE	_____
SPECIFIER	_____
QUANTITY	_____
DATE	_____

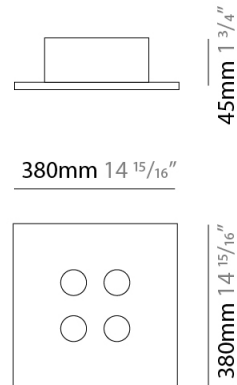
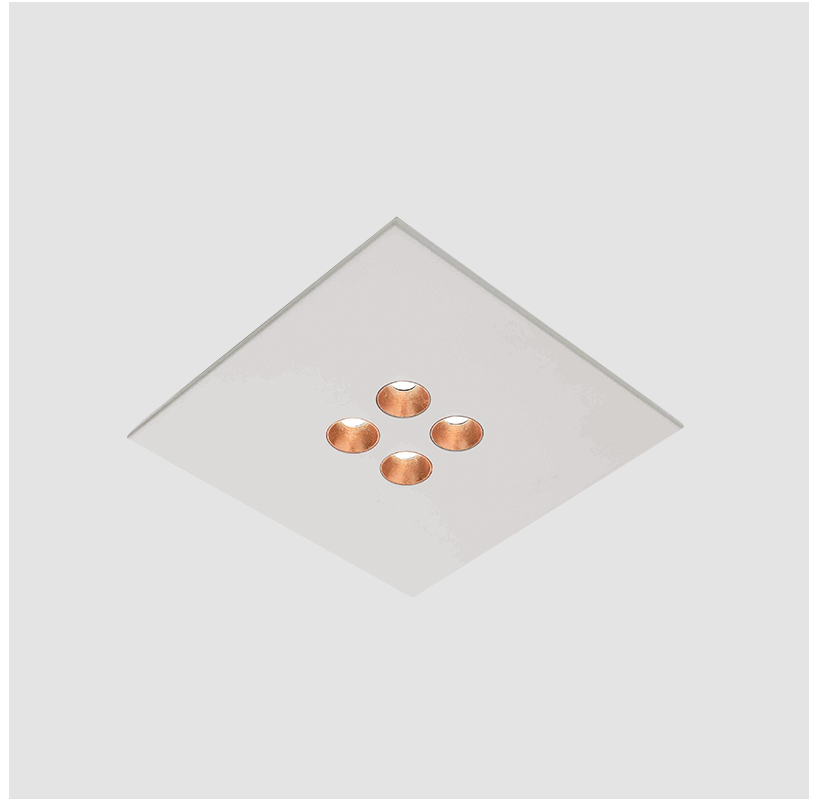

CONFORT SQUARE SURFACE

D42057-

PROJECT	_____
TYPE	_____
SPECIFIER	_____
QUANTITY	_____
DATE	_____

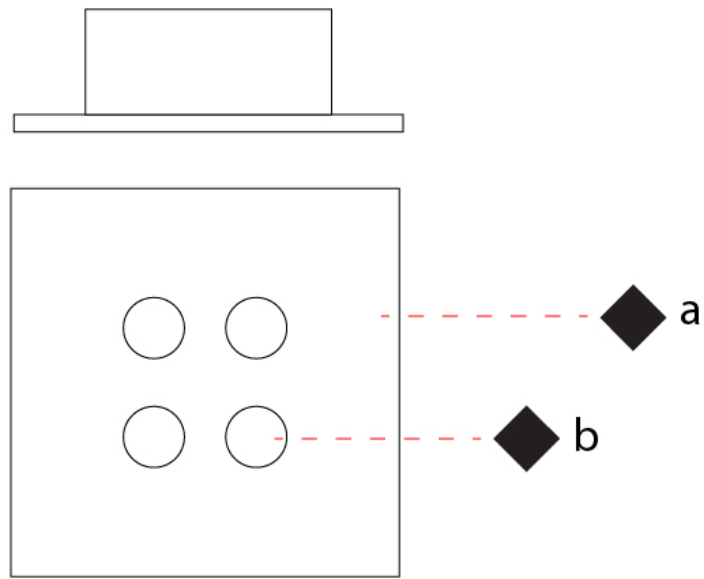

PROJECT	_____
TYPE	_____
SPECIFIER	_____
QUANTITY	_____
DATE	_____

CONFORT RECTANGLE SURFACE

D42058-

base number Finish
Options

- To build a product code in our configurator select the specify button on the base model # product page
- To build a manual product code on this datasheet choose from the options listed below in blue font and add the suffix to the base model #

GENERAL

Series: Confort _____
 Subseries: Confort Rectangle _____
 Partner: Icone _____
 Division: Design _____
 Installation: Surface _____
 Product Type: Ceiling Surface _____
 Mounting Location: Ceiling _____
 Light Distribution: Direct _____

PHYSICAL

Shape: Rectangle _____
 Length (mm): 710 _____
 Length (in): 27 ¹⁵/₁₆ _____
 Width (mm): 200 _____
 Width (in): 7 ⁷/₈ _____
 Height (mm): 45 _____
 Height (in): 1 ³/₄ _____
 Fixture Finish: WAM / WAN / WGF / WCL / WPW / BKA / BAN / BGL / BCL / BPW _____
 Fixture Material: Aluminum _____

ELECTRICAL

Lamp Type: LED _____
 Total Output Wattage (W): 27 _____
 Dimming: Electronic Low Voltage Dimming _____
 Input Voltage (V): 120Vac Direct Line _____

LED

Number of LEDs: 6 _____
 Color Temperature (°K): 3000 _____
 Nominal Lumen (lm): 2100 _____
 CRI: >90 CRI _____
 Lamp Life (hrs): 50000 _____

OPTICAL

RATINGS AND CERTIFICATIONS

Certified By: Certified for North American Standards _____
 IP rating: IP20 _____

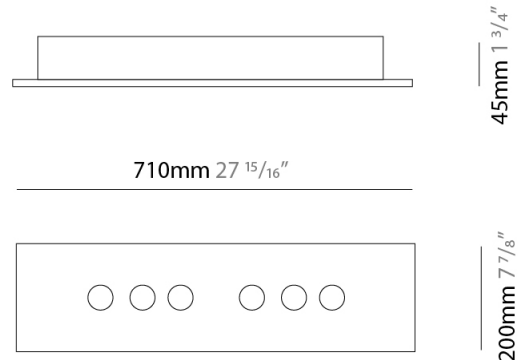
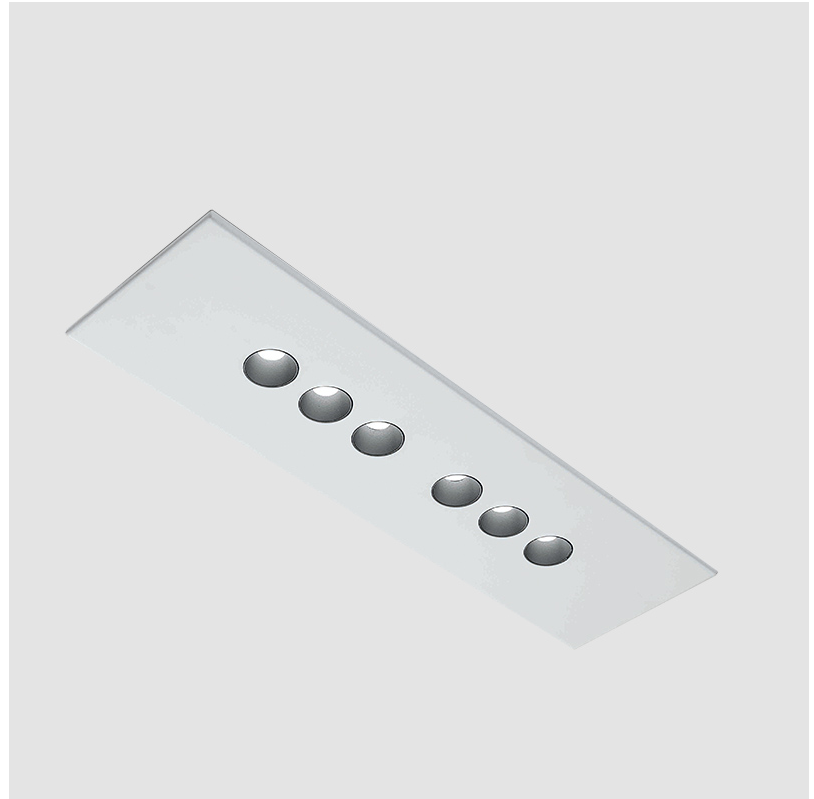

CONFORT RECTANGLE SURFACE

D42058-

PROJECT	_____
TYPE	_____
SPECIFIER	_____
QUANTITY	_____
DATE	_____

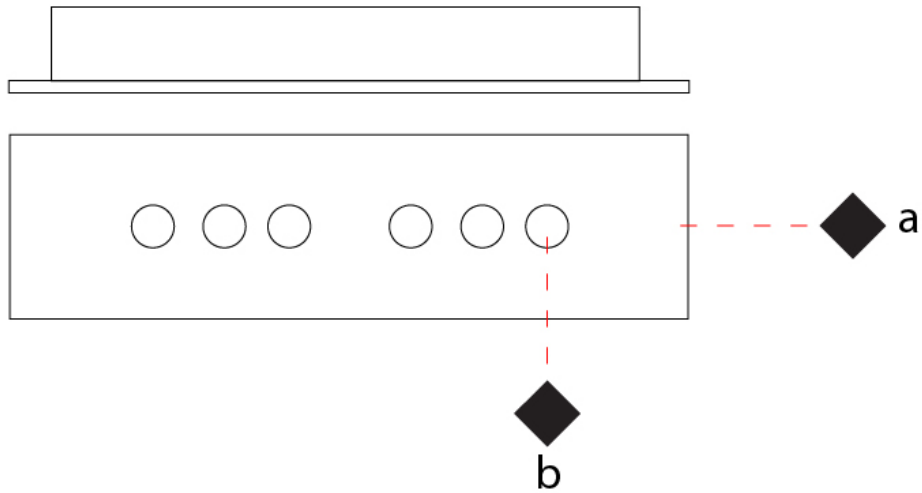

D

PROJECT
TYPE
SPECIFIER
QUANTITY
DATE

CONFORT SQUARE SURFACE

D42059-

base number Finish
Options

- To build a product code in our configurator select the specify button on the base model # product page
- To build a manual product code on this datasheet choose from the options listed below in blue font and add the suffix to the base model #

GENERAL

Series: Confort
 Subseries: Confort Square
 Partner: Icone
 Division: Design
 Installation: Surface
 Product Type: Ceiling Surface
 Mounting Location: Ceiling
 Light Distribution: Direct

PHYSICAL

Shape: Square
 Length (mm): 450
 Length (in): 17 ¹¹/₁₆
 Width (mm): 450
 Width (in): 17 ¹¹/₁₆
 Fixture Finish: WAM / WAN / WGF / WCL / WPW / BKA / BAN / BGL / BCL / BPW
 Fixture Material: Aluminum

ELECTRICAL

Lamp Type: LED
 Total Output Wattage (W): 36
 Dimming: Electronic Low Voltage Dimming
 Input Voltage (V): 120Vac Direct Line

LED

Number of LEDs: 8
 Color Temperature (°K): 3000
 Nominal Lumen (lm): 2800
 CRI: >90 CRI
 Lamp Life (hrs): 50000

OPTICAL

RATINGS AND CERTIFICATIONS

Certified By: Certified for North American Standards
 IP rating: IP20

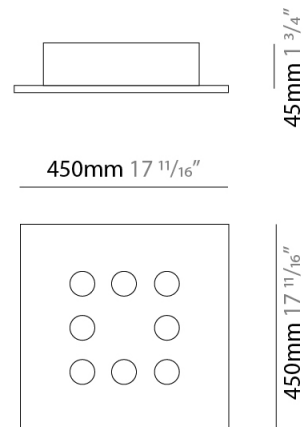
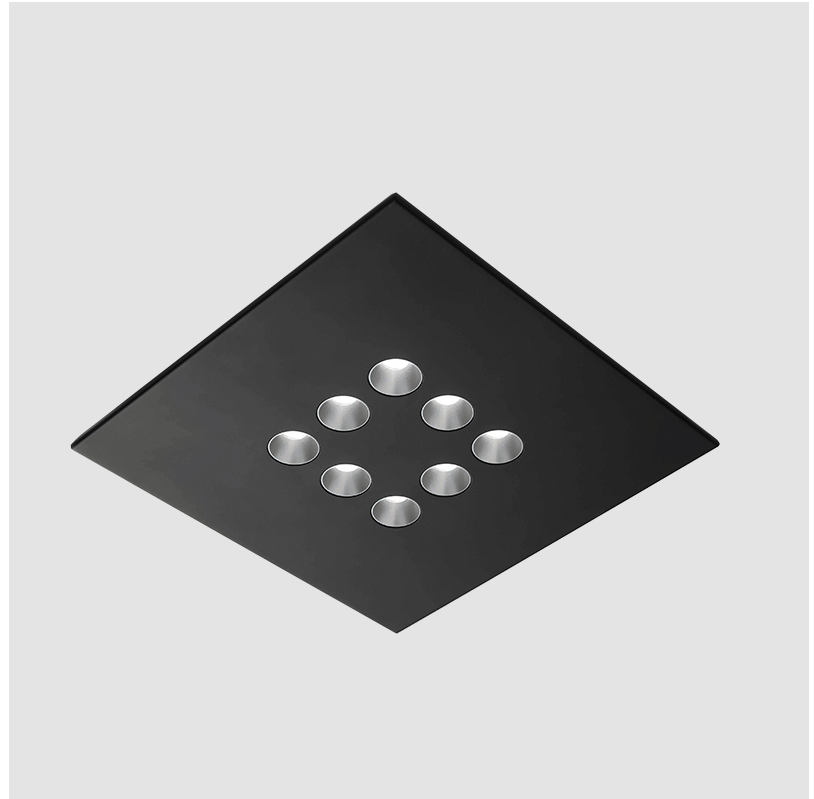

CONFORT SQUARE SURFACE

D42059-

PROJECT _____

TYPE _____

SPECIFIER _____

QUANTITY _____

DATE _____

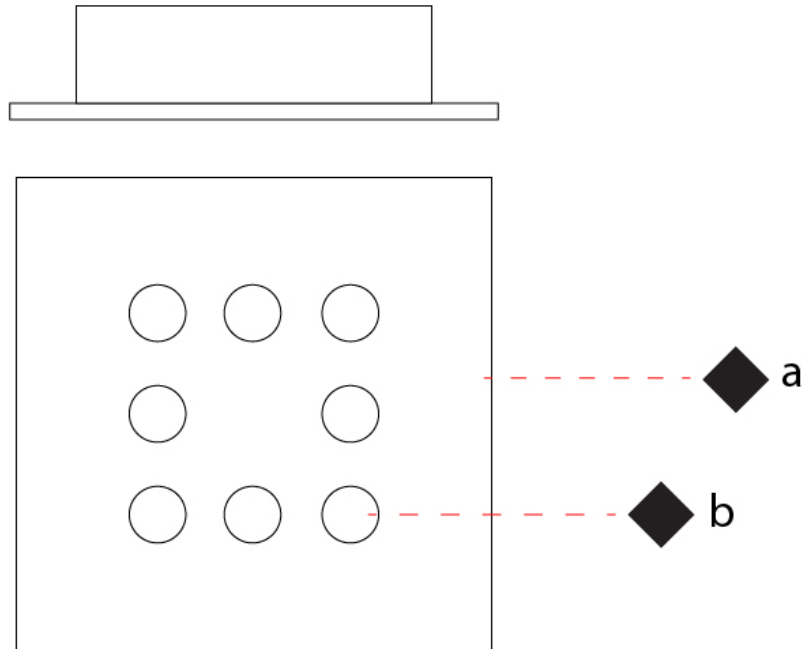

D

CONFORT RECTANGLE SURFACE

D42060-

base number Finish
Options

PROJECT	_____
TYPE	_____
SPECIFIER	_____
QUANTITY	_____
DATE	_____

- To build a product code in our configurator select the specify button on the base model # product page
- To build a manual product code on this datasheet choose from the options listed below in blue font and add the suffix to the base model #

GENERAL

Series: Confort _____
 Subseries: Confort Rectangle _____
 Partner: Icone _____
 Division: Design _____
 Installation: Surface _____
 Product Type: Ceiling Surface _____
 Mounting Location: Ceiling _____
 Light Distribution: Direct _____

PHYSICAL

Shape: Rectangle _____
 Length (mm): 970 _____
 Length (in): 38 ³/₁₆ _____
 Width (mm): 200 _____
 Width (in): 7 ⁷/₈ _____
 Fixture Finish: WAM / WAN / WGF / WCL / WPW / BKA / BAN / BGL / BCL / BPW _____
 Fixture Material: Aluminum _____

ELECTRICAL

Lamp Type: LED _____
 Total Output Wattage (W): 40.5 _____
 Dimming: Electronic Low Voltage Dimming _____
 Input Voltage (V): 120Vac Direct Line _____

LED

Number of LEDs: 9 _____
 Color Temperature (°K): 3000 _____
 Nominal Lumen (lm): 3150 _____
 CRI: >90 CRI _____
 Lamp Life (hrs): 50000 _____

OPTICAL

RATINGS AND CERTIFICATIONS

Certified By: Certified for North American Standards _____
 IP rating: IP20 _____

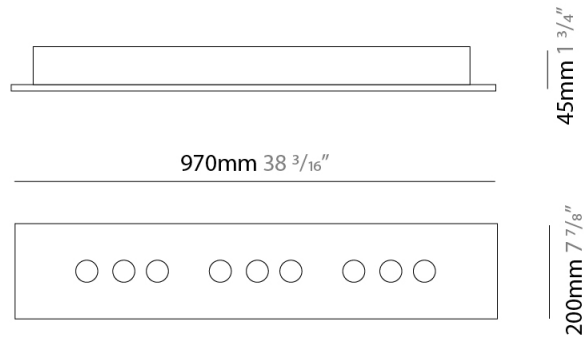

CONFORT RECTANGLE SURFACE

D42060-

PROJECT	_____
TYPE	_____
SPECIFIER	_____
QUANTITY	_____
DATE	_____

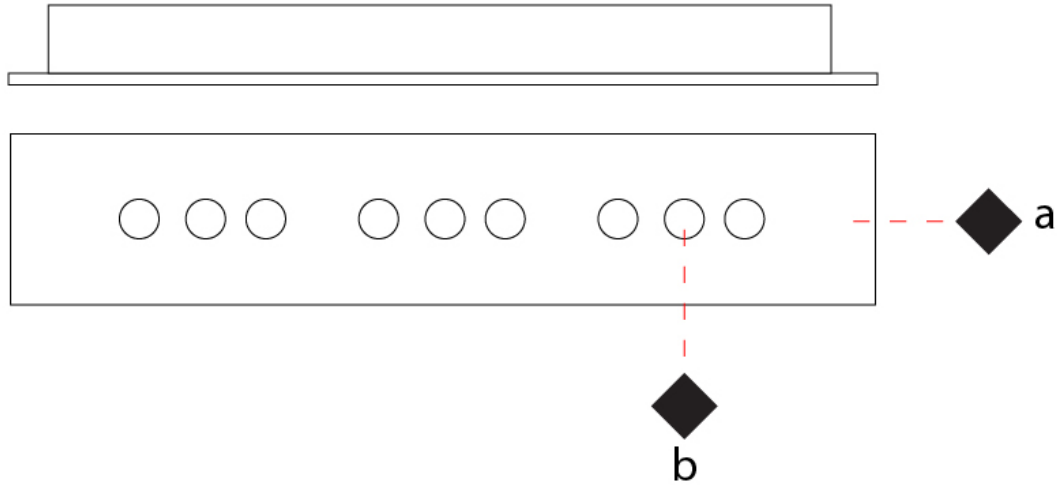

D

PROJECT	_____
TYPE	_____
SPECIFIER	_____
QUANTITY	_____
DATE	_____

CONFORT SQUARE SURFACE

D42061-

base number Finish
Options

- To build a product code in our configurator select the specify button on the base model # product page
- To build a manual product code on this datasheet choose from the options listed below in blue font and add the suffix to the base model #

GENERAL

Series: Confort _____
 Subseries: Confort Square _____
 Partner: Icone _____
 Division: Design _____
 Installation: Surface _____
 Product Type: Ceiling Surface _____
 Mounting Location: Ceiling _____
 Light Distribution: Direct _____

PHYSICAL

Shape: Square _____
 Length (mm): 650 _____
 Length (in): 25 ⁹/₁₆ _____
 Width (mm): 650 _____
 Width (in): 25 ⁹/₁₆ _____
 Fixture Finish: WAM / WAN / WGF / WCL / WPW / BKA / BAN / BGL / BCL / BPW _____
 Fixture Material: Aluminum _____

ELECTRICAL

Lamp Type: LED _____
 Total Output Wattage (W): 54 _____
 Dimming: Electronic Low Voltage Dimming _____
 Input Voltage (V): 120Vac Direct Line _____

LED

Number of LEDs: 12 _____
 Color Temperature (°K): 3000 _____
 Nominal Lumen (lm): 4200 _____
 CRI: >90 CRI _____
 Lamp Life (hrs): 50000 _____

OPTICAL

RATINGS AND CERTIFICATIONS

Certified By: Certified for North American Standards _____
 IP rating: IP20 _____

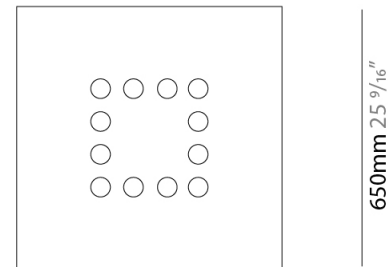
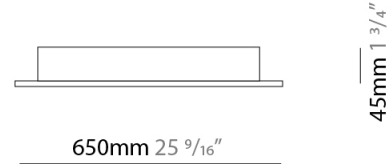
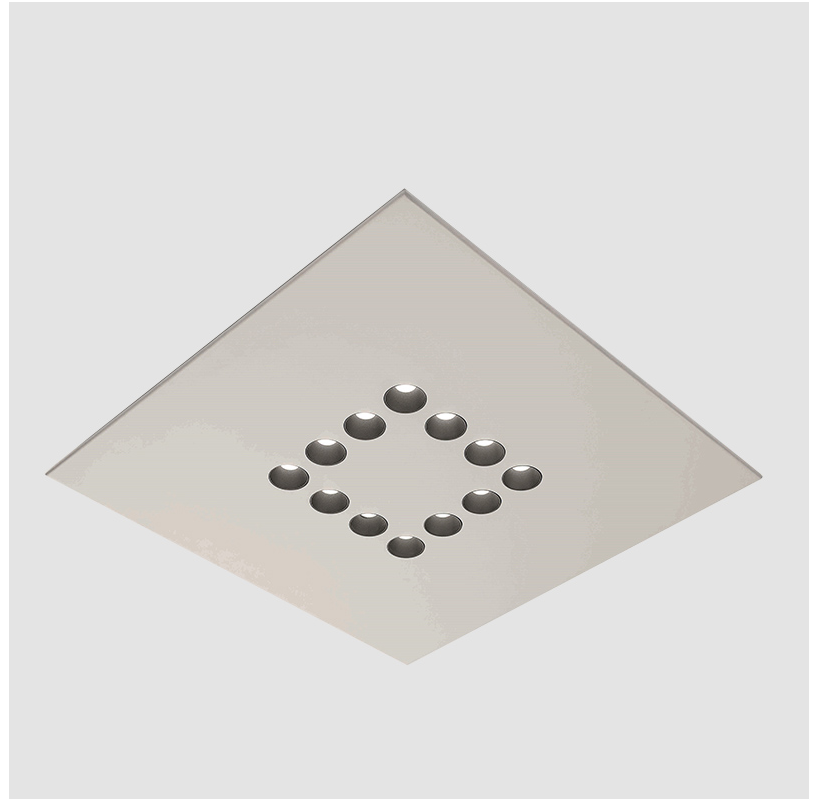

CONFORT SQUARE SURFACE

D42061-

PROJECT _____

TYPE _____

SPECIFIER _____

QUANTITY _____

DATE _____

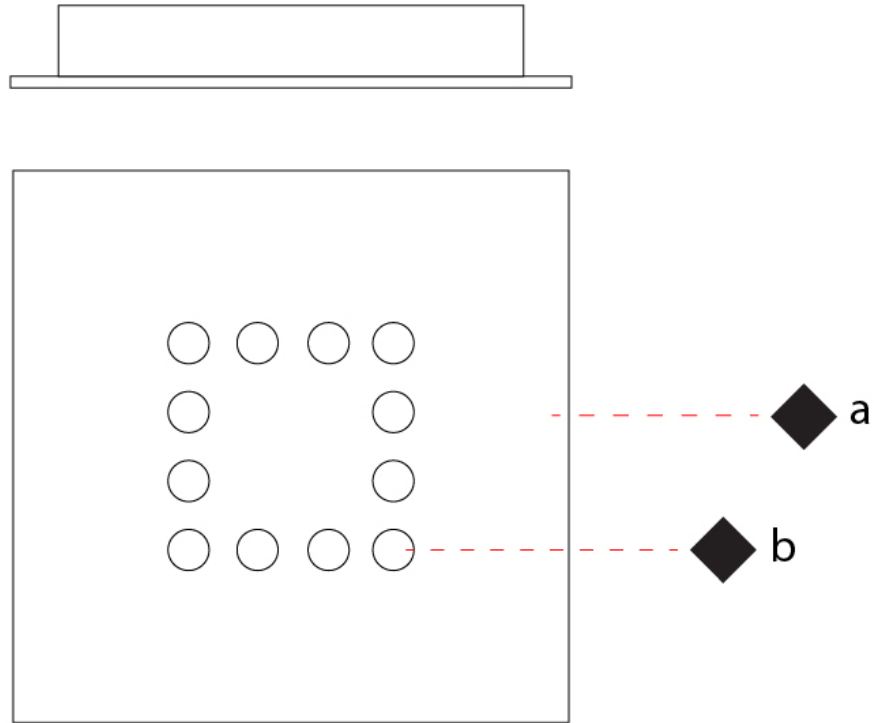

D

CONFORT COLOR FINISH CHART

PROJECT _____

TYPE _____

SPECIFIER _____

QUANTITY _____

DATE _____

Fixture Finish

White/Aluminium - WAM



White/Anthracite - WAN



White/Gold Leaf - WGF



White/Copper Leaf - WCL



White/Pearl - WPW



Black/Aluminium - BKA

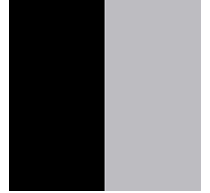

Black/Anthracite - BAN



Black/Gold Leaf - BGL

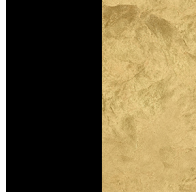

Black/Copper Leaf - BCL

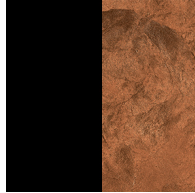

Black/Pearl - BPW



Digital: Not all screens are calibrated the same, and therefore, colors will appear differently between screens.











Physical: When texture is involved, there will be variations in color, character and tone within a product series and between product families.













LEGEND

	floor-mounted		pivotal		special LED (upon request) RGB, RGBW, tunable, gold+, meat+, art+, fashion+
	wall and ceiling: recessed and surface mounted		rotating		warm dim / natural dimming LED
	ceiling-mounted and wall-mounted		illuminate tilted		rechargeable battery powered
	wall-mounted		color of suspension cable		fixture with natural vivid LED (upon request)
	omni-directional light distribution		length of suspension cable		color rendering index
	direct light distribution		reflector degree selection		color temperature
	direct/indirect light distribution		super spot		lumen (luminous flux)
	indirect light distribution		lens		efficacy (lumens per watt)
	asymmetric light distribution		lens pack		Unified Glare Rating (UGR) range from 5-40
	aura light distribution		shine ring		marine grade (AISI 316 stainless steel)
	round wall or ceiling cut-out		integrated shine ring with diffuser		walk on
	square wall or ceiling cut-out		free individual colors 01-29		drive on
	the supplied jig specifies the cutout dimensions		individual colors: 00 (free of charge), 01-25 (extra charge)		Dark Sky Compliance
	minimum distance (meters) lamp - object		luminaire part to be colored (F1)		Americans with Disabilities Act (less than 4" off the wall located between 27"-84" from floor)
	recessed depth		luminaire part to be colored (F2)		lamp protected against explosion
	ceiling thickness in mm		luminaire part to be colored (F3)		blown glass using traditional methods by master glass blower
	ceiling thickness selection		luminaire part to be colored (F4)		acoustic material
	dimnable DP (phase), DV (0-10V), DD (dali), DS (step-dim)		luminaire part to be colored (F5)		protection class I, protection insulation
	included or excluded LED driver/transformer/control gear		color of 3-circuit adaptor		protection class II, protection insulation
	separately switchable		indirect diffuser		ETL Certified to UL and CSA Standards
	sensor		direct diffuser		UL Certified to UL and CSA Standards
	remote control		ball-proof (upon request)		CSA Certified to UL and CSA Standards
	available upon request		accessory		Certified for North American Standards

IP RATING

	protected against ingress of solid bodies greater than 12.5mm (finger)
	protected against ingress of solid bodies greater than 2.5mm protected against sprays of water up to 60 degrees from the vertical (rain)
	protected against ingress of solid bodies greater than 1mm (wire) no protection against the ingress of moisture
	protected against ingress of solid bodies greater than 1mm (wire) protected against sprays of water up to 60 degrees from the vertical (rain)
	protected against ingress of solid bodies greater than 1mm (wire) protected against water splashed from all directions
	protected against limited ingress of dust (wet rooms/covered outdoor areas) protected against water splashed from all directions
	protected against ingress of dust protected against jets of water
	protected against ingress of dust protected against powerful jets of water or heavy seas
	protected against ingress of dust protected against immersion of water between 15cm - 1m for 30 minutes
	protected against ingress of dust protected against immersion of water under pressure for long periods

IK RATING

	protected against 0.14 joules impact (equivalent to 0.25kg mass dropped from 56mm above the surface)
	protected against 0.2 joules impact (equivalent to 0.25kg mass dropped from 80mm above the surface)
	protected against 0.35 joules impact (equivalent to 0.25kg mass dropped from 140mm above the surface)
	protected against 0.5 joules impact (equivalent to 0.25kg mass dropped from 200mm above the surface)
	protected against 0.7 joules impact (equivalent to 0.25kg mass dropped from 280mm above the surface)
	protected against 1 joules impact (equivalent to 0.25kg mass dropped from 400mm above the surface)
	protected against 2 joules impact (equivalent to 0.5kg mass dropped from 400mm above the surface)
	protected against 5 joules impact (equivalent to 1.7kg mass dropped from 300mm above the surface)
	protected against 10 joules impact (equivalent to 5.0kg mass dropped from 200mm above the surface)
	protected against 20 joules impact (equivalent to 5.0kg mass dropped from 400mm above the surface)