

CRASH SUSPENSION

D131557- _____
base number

1. To build a product code in our configurator select the specify button on the base model # product page
2. To build a manual product code on this datasheet choose from the options listed below in blue font and add the suffix to the base model #

GENERAL

Series: Crash
 Brand: Knikerboker
 Division: Design
 Mounting Type: Suspension
 Mounting Location: Ceiling
 Subcategory: Pendant

PHYSICAL

Shape: Abstract
 Length (mm): 1300
 Length (in): 51 ³/₁₆
 Width (mm): 400
 Width (in): 15 ³/₄
 Height (mm): 250
 Height (in): 9 ¹³/₁₆
 Max. Overall Height (mm): 2250
 Max. Overall Height (in): 88 ⁷/₁₆
 Light Distribution: Indirect
 Fixture Finish: EWH / EBK / MAN / COF / PRD / SLF / GLF / CLF / BRL / EWS / EWG / EWC / EWR / EBS / EBG / EBC / EBC / EBB / MAS / MAD / MAC / MAB / COS / CGO / CCL / CBL / PRS / PRG / PRC / PRB
 Fixture Material: Metal
 Cable Details: 4 Steel Cable 2000mm / 78 3/4" - Silicon Cable 2000mm / 78 3/4"

ELECTRICAL

Lamp Type: LED
 Total Output Wattage (W): 20
 Dimming: 0-10V Dimming / Phase Dimming (120Vac Only)
 Driver Included: Yes
 Driver Location: Integrated
 Driver Type: Constant Voltage - Universal
 Driver Class: Class 2
 Input Voltage (V): 120 - 277
 Output Voltage (V): 24
 Upon Request: (Not included - see components) Remote: 0-10Vdc dimming / Phase dimming @120Vac only / (Included) Integral Non-dimming 277Vac

LED

Color Temperature (°K): 3000
 Max. Delivered Lumen (lm): 3000
 CRI: >85 CRI
 Lamp Life (hrs): 50000

OPTICAL

RATINGS AND CERTIFICATIONS

Certified By: CSA Certified to UL and CSA Standards
 IP rating: IP20



+/- 25

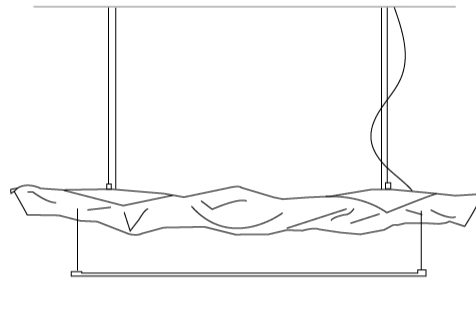

1300mm 51 ³/₁₆"



CRASH SUSPENSION

D131557-

PROJECT _____

TYPE _____

SPECIFIER _____

QUANTITY _____

DATE _____

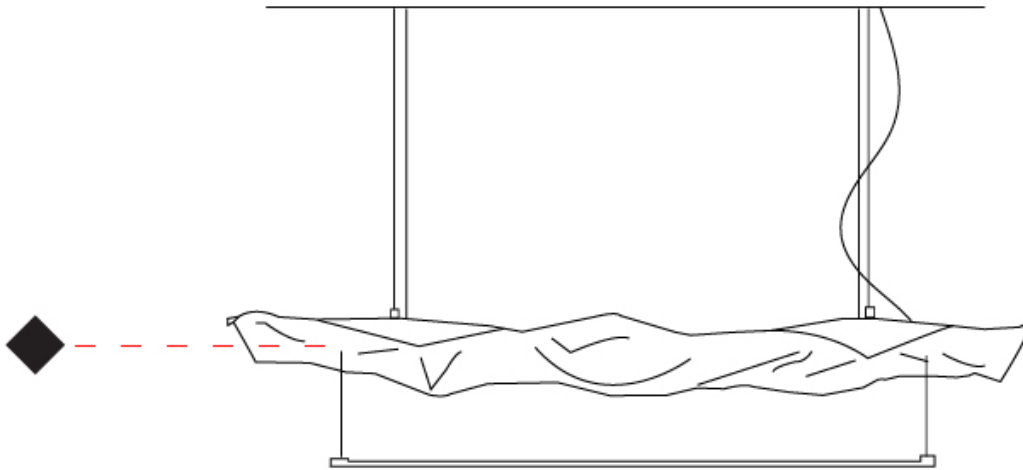

D

| |
|-----------|
| PROJECT |
| TYPE |
| SPECIFIER |
| QUANTITY |
| DATE |

CRASH SURFACE

D132109- _____
base number

- To build a product code in our configurator select the specify button on the base model # product page
- To build a manual product code on this datasheet choose from the options listed below in blue font and add the suffix to the base model #

GENERAL

Series: Crash
 Brand: Knikerboker
 Division: Design
 Mounting Type: Surface
 Mounting Location: Ceiling
 Subcategory: Pendant

PHYSICAL

Shape: Abstract
 Length (mm): 200
 Length (in): 7 7/8
 Width (mm): 200
 Width (in): 7 7/8
 Height (mm): 250
 Height (in): 9 13/16
 Light Distribution: Indirect
 Fixture Finish: EWH / EBK / MAN / COF / PRD / SLF / GLF / CLF / BRL / EWS / EWG / EWC / EWR / EBS / EBG / EBC / EBB / MAS / MAD / MAC / MAB / COS / CGO / CCL / CBL / PRS / PRG / PRC / PRB
 Fixture Material: Metal

ELECTRICAL

Lamp Type: LED
 Input Wattage (W): 10.5
 Total Output Wattage (W): 10
 Dimming: Tri-Mode (Non-Dimming and Phase Dimming (120Vac only) and 0-10V Dimming)
 Driver Included: Yes
 Driver Location: Integrated
 Driver Type: Constant Current - Universal
 Driver Class: Class 2
 Input Voltage (V): 120 - 277
 Constant Current (MA): 250
 Upon Request: 0-10Vdc Dimming / Phase dimming @120Vac only / Non-dimming 120/277Vac

LED

Number of LEDs: 1
 Color Temperature (°K): 3000
 Max. Delivered Lumen (lm): 1100
 CRI: >85 CRI
 Lamp Life (hrs): 50000

OPTICAL

RATINGS AND CERTIFICATIONS

Certified By: Certified for North American Standards
 IP rating: IP20

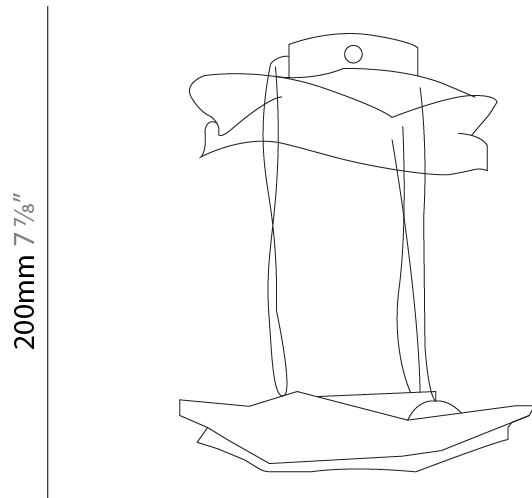
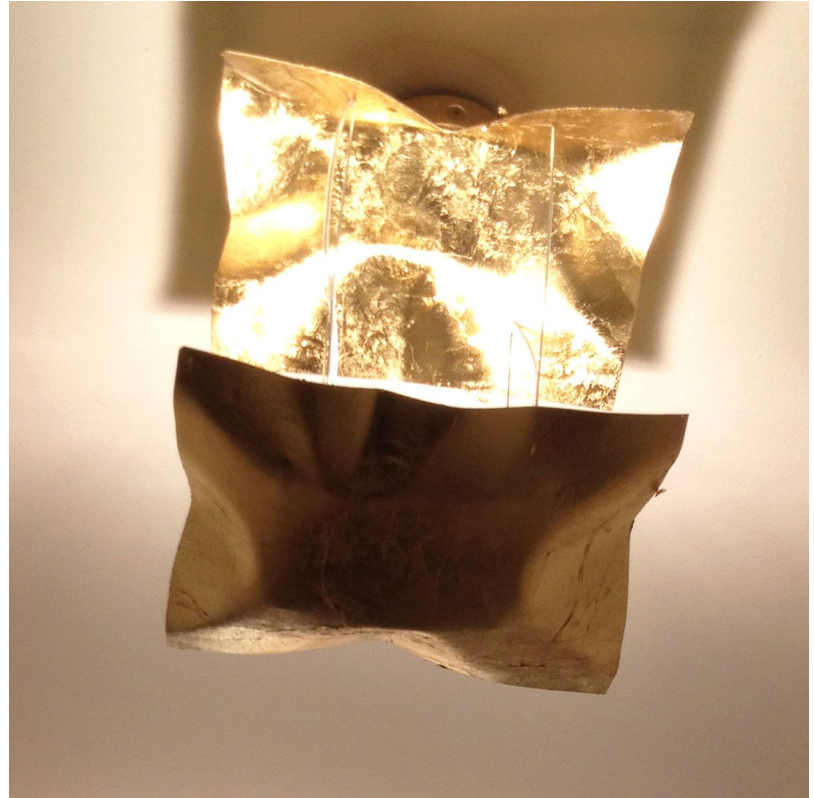

200mm 7 7/8"

200mm 7 7/8"



CRASH SURFACE

D132109-

PROJECT _____

TYPE _____

SPECIFIER _____

QUANTITY _____

DATE _____

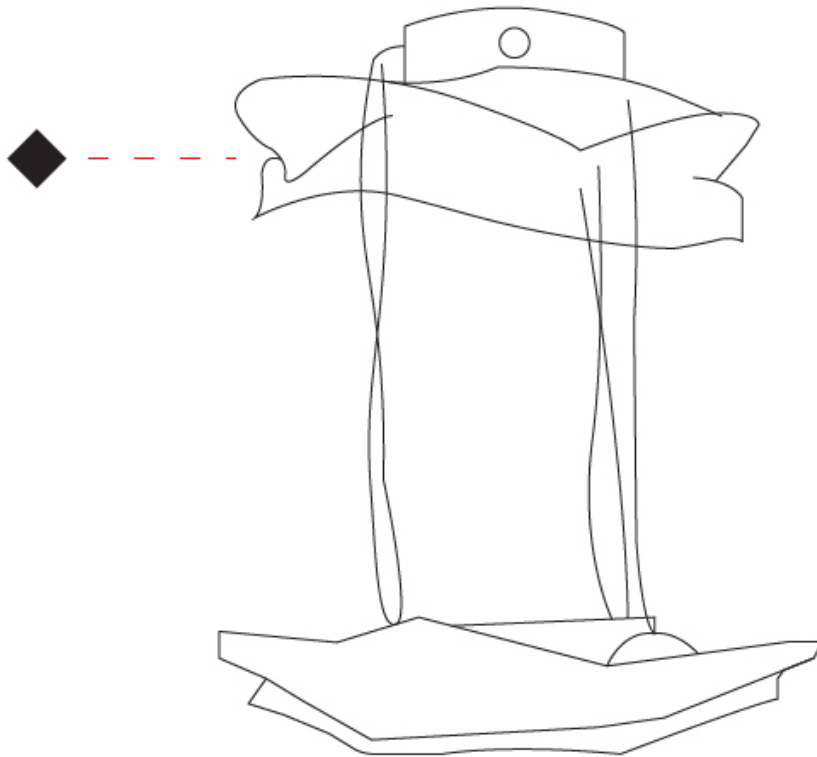

D

CRASH

COLOR FINISH CHART

Fixture Finish

Embossed White - EWH



Embossed Black - EBK



Metallic Anthracite - MAN



Coffee - COF

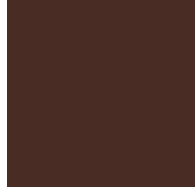

Purple Red - PRD



Silver Leaf - SLF

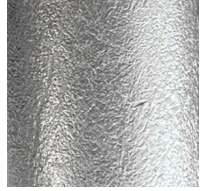

Gold Leaf - GLF



Copper Leaf - CLF



Bronze Leaf - BRL



Metallic Anthracite / Silver Leaf - MAS

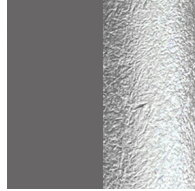

Metallic Anthracite / Gold Leaf - MAD

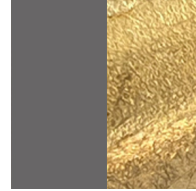

Metallic Anthracite / Copper Leaf - MAC

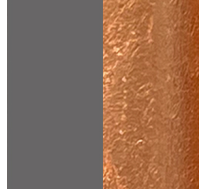

Metallic Anthracite / Bronze Leaf - MAB

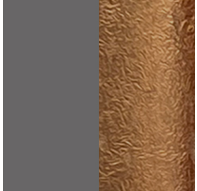

Coffee / Silver Leaf - COS

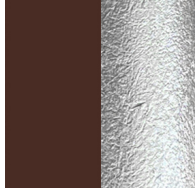

Coffee / Gold Leaf - CGO

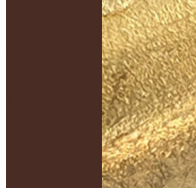

Coffee / Copper Leaf - CCL



Coffee / Bronze Leaf - CBL



Purple Red / Silver Leaf - PRS

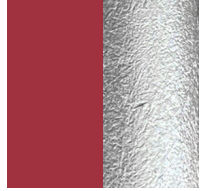

Purple Red / Gold Leaf - PRG



Purple Red / Copper Leaf - PRC



Purple Red / Bronze Leaf - PRB



Digital: Not all screens are calibrated the same, and therefore, colors will appear differently between screens.

Physical: When texture is involved, there will be variations in color, character and tone within a product series and between product families.



| | |
|-----------|--|
| PROJECT | |
| TYPE | |
| SPECIFIER | |
| QUANTITY | |
| DATE | |

LEGEND

| | | | | | |
|--|---|--|--|--|--|
| | floor-mounted | | pivotable | | special LED (upon request) RGB, RGBW, tunable, gold+, meat+, art+, fashion+ |
| | wall and ceiling: recessed and surface mounted | | rotating | | warm dim / natural dimming LED |
| | ceiling-mounted and wall-mounted | | illuminate tilted | | rechargeable battery powered |
| | wall-mounted | | color of suspension cable | | fixture with natural vivid LED (upon request) |
| | omni-directional light distribution | | length of suspension cable | | color rendering index |
| | direct light distribution | | reflector degree selection | | color temperature |
| | direct/indirect light distribution | | super spot | | lumen (luminous flux) |
| | indirect light distribution | | lens | | efficacy (lumens per watt) |
| | asymmetric light distribution | | lens pack | | Unified Glare Rating (UGR) range from 5-40 |
| | aura light distribution | | shine ring | | marine grade (AISI 316 stainless steel) |
| | round wall or ceiling cut-out | | integrated shine ring with diffuser | | walk on |
| | square wall or ceiling cut-out | | free individual colors 01-29 | | drive on |
| | the supplied jig specifies the cutout dimensions | | individual colors: 00 (free of charge), 01-25 (extra charge) | | Dark Sky Compliance |
| | minimum distance (meters) lamp - object | | luminaire part to be colored (F1) | | Americans with Disabilities Act (less than 4" off the wall located between 27"-84" from floor) |
| | recessed depth | | luminaire part to be colored (F2) | | lamp protected against explosion |
| | ceiling thickness in mm | | luminaire part to be colored (F3) | | blown glass using traditional methods by master glass blower |
| | ceiling thickness selection | | luminaire part to be colored (F4) | | acoustic material |
| | dimmable DP (phase), DV (0-10V), DD (dali), DS (step-dim) | | luminaire part to be colored (F5) | | protection class I, protection insulation |
| | included or excluded LED driver/transformer/control gear | | color of 3-circuit adaptor | | protection class II, protection insulation |
| | separately switchable | | indirect diffuser | | ETL Certified to UL and CSA Standards |
| | sensor | | direct diffuser | | UL Certified to UL and CSA Standards |
| | remote control | | ball-proof (upon request) | | CSA Certified to UL and CSA Standards |
| | available upon request | | accessory | | Certified for North American Standards |

IP RATING

| | |
|--|--|
| | protected against ingress of solid bodies greater than 12.5mm (finger) |
| | protected against ingress of solid bodies greater than 2.5mm protected against sprays of water up to 60 degrees from the vertical (rain) |
| | protected against ingress of solid bodies greater than 1mm (wire) no protection against the ingress of moisture |
| | protected against ingress of solid bodies greater than 1mm (wire) protected against sprays of water up to 60 degrees from the vertical (rain) |
| | protected against ingress of solid bodies greater than 1mm (wire) protected against water splashed from all directions |
| | protected against limited ingress of dust (wet rooms/covered outdoor areas) protected against water splashed from all directions |
| | protected against ingress of dust protected against jets of water |
| | protected against ingress of dust protected against powerful jets of water or heavy seas |
| | protected against ingress of dust protected against immersion of water between 15cm - 1m for 30 minutes |
| | protected against ingress of dust protected against immersion of water under pressure for long periods |

IK RATING

| | |
|--|---|
| | protected against 0.14 joules impact (equivalent to 0.25kg mass dropped from 56mm above the surface) |
| | protected against 0.2 joules impact (equivalent to 0.25kg mass dropped from 80mm above the surface) |
| | protected against 0.35 joules impact (equivalent to 0.25kg mass dropped from 140mm above the surface) |
| | protected against 0.5 joules impact (equivalent to 0.25kg mass dropped from 200mm above the surface) |
| | protected against 0.7 joules impact (equivalent to 0.25kg mass dropped from 280mm above the surface) |
| | protected against 1 joules impact (equivalent to 0.25kg mass dropped from 400mm above the surface) |
| | protected against 2 joules impact (equivalent to 0.5kg mass dropped from 400mm above the surface) |
| | protected against 5 joules impact (equivalent to 1.7kg mass dropped from 300mm above the surface) |
| | protected against 10 joules impact (equivalent to 5.0kg mass dropped from 200mm above the surface) |
| | protected against 20 joules impact (equivalent to 5.0kg mass dropped from 400mm above the surface) |