

## CRASH SUSPENSION

**D131065-** \_\_\_\_\_  
 base number

- To build a product code in our configurator select the specify button on the base model # product page
- To build a manual product code on this datasheet choose from the options listed below in blue font and add the suffix to the base model #

### GENERAL

Series: Crash  
 Brand: Knikerboker  
 Division: Design  
 Mounting Type: Suspension  
 Mounting Location: Ceiling  
 Subcategory: Pendant

### PHYSICAL

Shape: Abstract  
 Length (mm): 1000  
 Length (in): 39 <sup>3</sup>/<sub>16</sub>  
 Width (mm): 1000  
 Width (in): 39 <sup>3</sup>/<sub>16</sub>  
 Max. Overall Height (mm): 2000  
 Max. Overall Height (in): 78 <sup>3</sup>/<sub>4</sub>  
 Light Distribution: Indirect  
 Fixture Finish: EWH / EBK / MAN / COF / PRD / SLF / GLF / CLF / BRL / EWS / EWG / EWC / EWR / EBS / EBG / EBC / EBC / EBB / MAS / MAD / MAC / MAB / COS / CGO / CCL / CBL / PRS / PRG / PRC / PRB  
 Fixture Material: Metal  
 Cable Details: 4 Steel Cable 2000mm / 78 3/4" - Silicon Cable 2000mm / 78 3/4"

### ELECTRICAL

Lamp Type: LED Retrofit  
 Input Wattage (W): 21  
 Total Output Wattage (W): 20  
 Dimming: Tri-Mode (Non-Dimming and Phase Dimming (120Vac only) and 0-10V Dimming)  
 Driver Included: Yes  
 Driver Location: Integrated  
 Driver Type: Constant Current - Universal  
 Driver Class: Class 2  
 Input Voltage (V): 120 - 277  
 Constant Current (MA): 250  
 Upon Request: 0-10Vdc dimming / Phase dimming @120Vac / 277Vac

### LED

Number of LEDs: 2  
 Color Temperature (°K): 3000  
 Max. Delivered Lumen (lm): 2200  
 CRI: >85 CRI  
 Lamp Life (hrs): 50000

### OPTICAL

### RATINGS AND CERTIFICATIONS

Certified By: Certified for North American Standards  
 IP rating: IP20

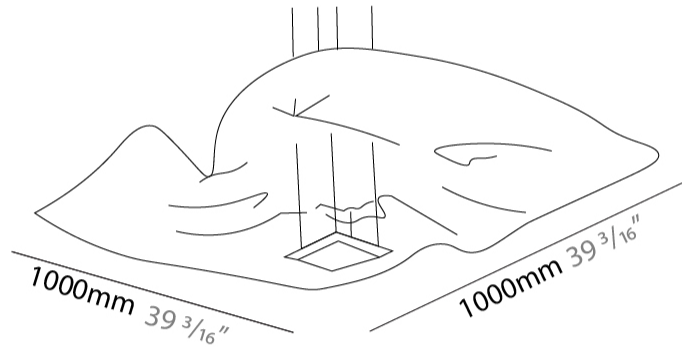

## CRASH SUSPENSION

D131065-

PROJECT

TYPE

SPECIFIER

QUANTITY

DATE



D

## CRASH SUSPENSION

**D131068-** \_\_\_\_\_  
base number

|           |
|-----------|
| PROJECT   |
| TYPE      |
| SPECIFIER |
| QUANTITY  |
| DATE      |

- To build a product code in our configurator select the specify button on the base model # product page
- To build a manual product code on this datasheet choose from the options listed below in blue font and add the suffix to the base model #

### GENERAL

Series: Crash  
 Brand: Knikerboker  
 Division: Design  
 Mounting Type: Suspension  
 Mounting Location: Ceiling  
 Subcategory: Pendant

### PHYSICAL

Shape: Curves  
 Length (mm): 1500  
 Length (in): 59 1/16  
 Width (mm): 1500  
 Width (in): 59 1/16  
 Max. Overall Height (mm): 2000  
 Max. Overall Height (in): 78 3/4  
 Light Distribution: Indirect  
 Fixture Finish: EWH / EBK / MAN / COF / PRD / SLF / GLF / CLF / BRL / EWS / EWG / EWC / EWR / EBS / EBG / EBC / EBC / EBB / MAS / MAD / MAC / MAB / COS / CGO / CCL / CBL / PRS / PRG / PRC / PRB  
 Fixture Material: Metal  
 Cable Details: 4 Steel Cable 2000mm / 78 3/4" - Silicon Cable 2000mm / 78 3/4"

### ELECTRICAL

Lamp Type: LED  
 Input Wattage (W): 31.5  
 Total Output Wattage (W): 30  
 Dimming: Tri-Mode (Non-Dimming and Phase Dimming (120Vac only) and 0-10V Dimming)  
 Driver Included: Yes  
 Driver Location: Integrated  
 Driver Type: Constant Current - Universal  
 Driver Class: Class 2  
 Input Voltage (V): 120 - 277  
 Constant Current (MA): 250  
 Upon Request: 0-10Vdc dimming / Phase dimming @120Vac / 277Vac

### LED

Number of LEDs: 3  
 Color Temperature (°K): 3000  
 Max. Delivered Lumen (lm): 3300  
 CRI: >85 CRI  
 Lamp Life (hrs): 50000

### OPTICAL

### RATINGS AND CERTIFICATIONS

Certified By: Certified for North American Standards  
 IP rating: IP20

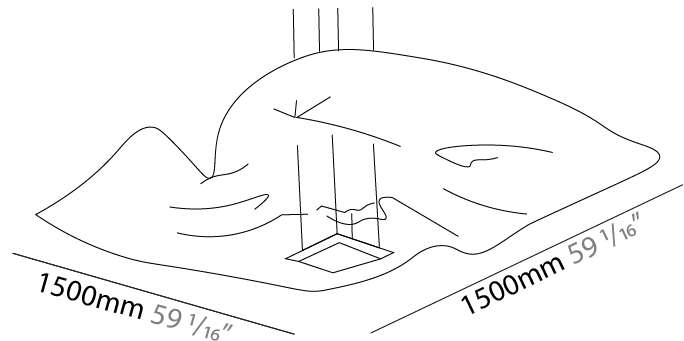

## CRASH SUSPENSION

D131068-

PROJECT \_\_\_\_\_

TYPE \_\_\_\_\_

SPECIFIER \_\_\_\_\_

QUANTITY \_\_\_\_\_

DATE \_\_\_\_\_



D

## CRASH SUSPENSION

**D131071-** \_\_\_\_\_  
 base number

- To build a product code in our configurator select the specify button on the base model # product page
- To build a manual product code on this datasheet choose from the options listed below in blue font and add the suffix to the base model #

### GENERAL

Series: Crash  
 Brand: Knikerboker  
 Division: Design  
 Mounting Type: Suspension  
 Mounting Location: Ceiling  
 Subcategory: Pendant

### PHYSICAL

Shape: Curves  
 Length (mm): 2500  
 Length (in): 98 7/16  
 Width (mm): 620  
 Width (in): 24 7/16  
 Max. Overall Height (mm): 2000  
 Max. Overall Height (in): 78 3/4  
 Light Distribution: Indirect  
 Fixture Finish: EWH / EBK / MAN / COF / PRD / SLF / GLF / CLF / BRL / EWS / EWG / EWC / EWR / EBS / EBG / EBC / EBC / EBB / MAS / MAD / MAC / MAB / COS / CGO / CCL / CBL / PRS / PRG / PRC / PRB  
 Fixture Material: Metal  
 Cable Details: 4 Steel Cable 2000mm / 78 3/4" - Silicon Cable 2000mm / 78 3/4"

### ELECTRICAL

Lamp Type: LED  
 Input Wattage (W): 42  
 Total Output Wattage (W): 40  
 Dimming: Tri-Mode (Non-Dimming and Phase Dimming (120Vac only) and 0-10V Dimming)  
 Driver Included: Yes  
 Driver Location: Integrated  
 Driver Type: Constant Current - Universal  
 Driver Class: Class 2  
 Input Voltage (V): 120 - 277  
 Constant Current (MA): 250  
 Upon Request: 0-10Vdc dimming / Phase dimming @120Vac / 277Vac

### LED

Number of LEDs: 4  
 Color Temperature (°K): 3000  
 Max. Delivered Lumen (lm): 4400  
 CRI: >85 CRI  
 Lamp Life (hrs): 50000

### OPTICAL

### RATINGS AND CERTIFICATIONS

Certified By: Certified for North American Standards  
 IP rating: IP20

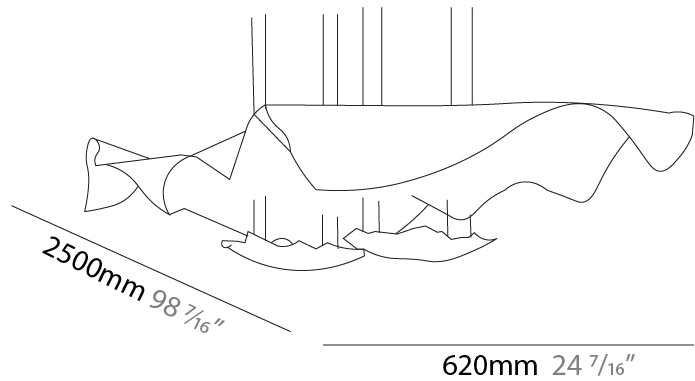
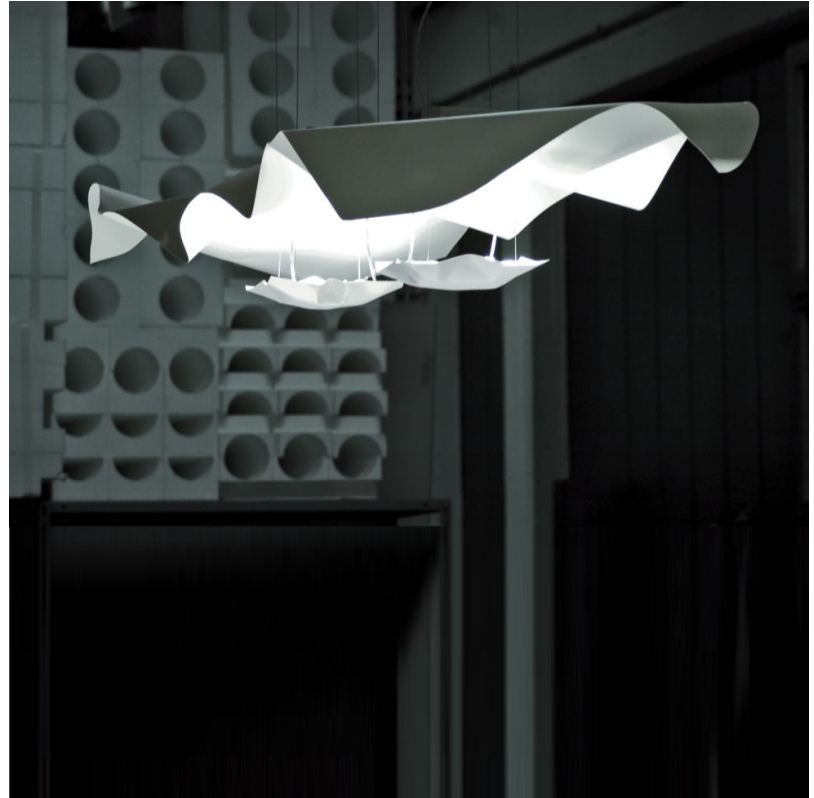

## CRASH SUSPENSION

D131071-

PROJECT \_\_\_\_\_

TYPE \_\_\_\_\_

SPECIFIER \_\_\_\_\_

QUANTITY \_\_\_\_\_

DATE \_\_\_\_\_



D

|           |
|-----------|
| PROJECT   |
| TYPE      |
| SPECIFIER |
| QUANTITY  |
| DATE      |

## CRASH SUSPENSION

**D131425-** \_\_\_\_\_  
base number

- To build a product code in our configurator select the specify button on the base model # product page
- To build a manual product code on this datasheet choose from the options listed below in blue font and add the suffix to the base model #

### GENERAL

Series: Crash  
 Brand: Knikerboker  
 Division: Design  
 Mounting Type: Suspension  
 Mounting Location: Ceiling  
 Subcategory: Pendant

### PHYSICAL

Shape: Abstract  
 Length (mm): 500  
 Length (in): 19 <sup>11</sup>/<sub>16</sub>  
 Width (mm): 500  
 Width (in): 19 <sup>11</sup>/<sub>16</sub>  
 Extension (mm): 2000  
 Extension (in): 78 <sup>3</sup>/<sub>4</sub>  
 Light Distribution: Indirect  
 Fixture Finish: EWH / EBK / MAN / COF / PRD / SLF / GLF / CLF / BRL / EWS / EWG / EWC / EWR / EBS / EBG / EBC / EBC / EBB / MAS / MAD / MAC / MAB / COS / CGO / CCL / CBL / PRS / PRG / PRC / PRB  
 Fixture Material: Metal  
 Cable Detail: 4 Steel Cable 2000mm / 78 3/4" - Silicon Cable 2000mm / 78 3/4"

### ELECTRICAL

Lamp Type: LED  
 Input Wattage (W): 10.5  
 Total Output Wattage (W): 10  
 Dimming: Tri-Mode (Non-Dimming and Phase Dimming (120Vac only) and 0-10V Dimming)  
 Driver Included: Yes  
 Driver Location: Integrated  
 Driver Type: Constant Current - Universal  
 Driver Class: Class 2  
 Input Voltage (V): 120 - 277  
 Constant Current (MA): 250  
 Upon Request: 0-10Vdc dimming / Phase dimming @120Vac / 277Vac

### LED

Color Temperature (°K): 3000  
 Max. Delivered Lumen (lm): 1100  
 CRI: >85 CRI  
 Lamp Life (hrs): 50000

### OPTICAL

### RATINGS AND CERTIFICATIONS

Certified By: Certified for North American Standards  
 IP rating: IP20

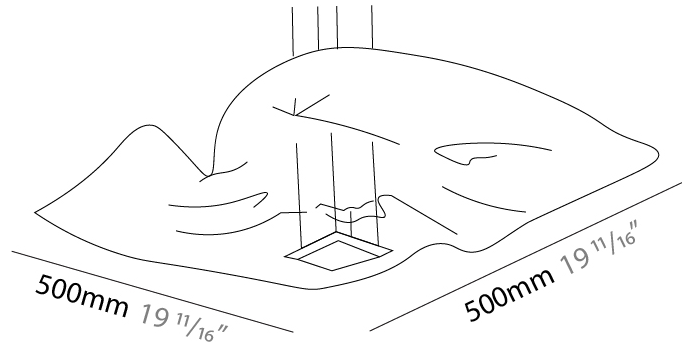

## CRASH SUSPENSION

D131425-

PROJECT \_\_\_\_\_

TYPE \_\_\_\_\_

SPECIFIER \_\_\_\_\_

QUANTITY \_\_\_\_\_

DATE \_\_\_\_\_

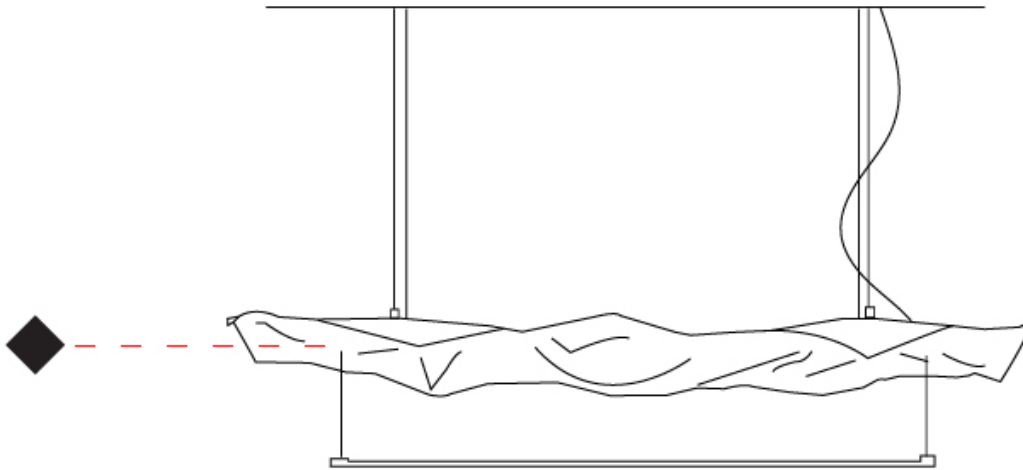

D



## CRASH SUSPENSION

**D131439-** \_\_\_\_\_  
 base number

- To build a product code in our configurator select the specify button on the base model # product page
- To build a manual product code on this datasheet choose from the options listed below in blue font and add the suffix to the base model #

### GENERAL

Series: Crash  
 Brand: Knikerboker  
 Division: Design  
 Mounting Type: Suspension  
 Mounting Location: Ceiling  
 Subcategory: Pendant

### PHYSICAL

Shape: Abstract  
 Length (mm): 1000  
 Length (in): 39 <sup>3</sup>/<sub>8</sub>  
 Width (mm): 750  
 Width (in): 29 <sup>1</sup>/<sub>2</sub>  
 Max. Overall Height (mm): 2000  
 Max. Overall Height (in): 78 <sup>3</sup>/<sub>4</sub>  
 Light Distribution: Indirect  
 Fixture Finish: EWH / EBK / MAN / COF / PRD / SLF / GLF / CLF / BRL / EWS / EWG / EWC / EWR / EBS / EBG / EBC / EBC / EBB / MAS / MAD / MAC / MAB / COS / CGO / CCL / CBL / PRS / PRG / PRC / PRB  
 Fixture Material: Metal  
 Cable Details: 4 Steel Cable 2000mm / 78 3/4" - Silicon Cable 2000mm / 78 3/4"

### ELECTRICAL

Lamp Type: LED  
 Input Wattage (W): 10.5  
 Total Output Wattage (W): 10  
 Dimming: Tri-Mode (Non-Dimming and Phase Dimming (120Vac only) and 0-10V Dimming)  
 Driver Included: Yes  
 Driver Location: Integrated  
 Driver Type: Constant Current - Universal  
 Driver Class: Class 2  
 Input Voltage (V): 120 - 277  
 Constant Current (MA): 250  
 Upon Request: 0-10Vdc dimming / Phase dimming @120Vac / 277Vac

### LED

Number of LEDs: 1  
 Color Temperature (°K): 3000  
 Max. Delivered Lumen (lm): 2200  
 CRI: >85 CRI  
 Lamp Life (hrs): 50000

### OPTICAL

### RATINGS AND CERTIFICATIONS

Certified By: Certified for North American Standards  
 IP rating: IP20

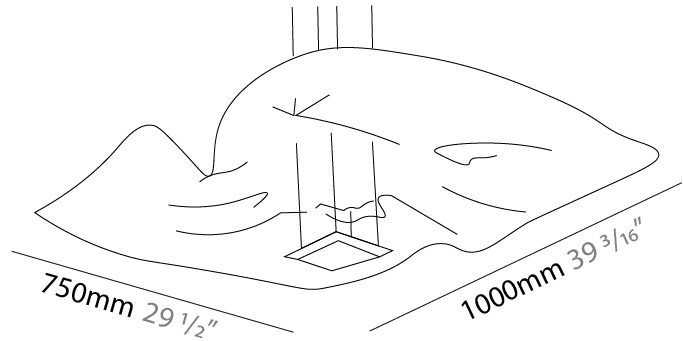

## CRASH SUSPENSION

D131439-

PROJECT \_\_\_\_\_

TYPE \_\_\_\_\_

SPECIFIER \_\_\_\_\_

QUANTITY \_\_\_\_\_

DATE \_\_\_\_\_



D

|           |       |
|-----------|-------|
| PROJECT   | _____ |
| TYPE      | _____ |
| SPECIFIER | _____ |
| QUANTITY  | _____ |
| DATE      | _____ |

## CRASH SUSPENSION

**D131557-** \_\_\_\_\_  
base number

- To build a product code in our configurator select the specify button on the base model # product page
- To build a manual product code on this datasheet choose from the options listed below in blue font and add the suffix to the base model #

### GENERAL

Series: Crash  
 Brand: Knikerboker  
 Division: Design  
 Mounting Type: Suspension  
 Mounting Location: Ceiling  
 Subcategory: Pendant

### PHYSICAL

Shape: Abstract  
 Length (mm): 1300  
 Length (in): 51 <sup>3</sup>/<sub>16</sub>  
 Width (mm): 400  
 Width (in): 15 <sup>3</sup>/<sub>4</sub>  
 Height (mm): 250  
 Height (in): 9 <sup>13</sup>/<sub>16</sub>  
 Max. Overall Height (mm): 2250  
 Max. Overall Height (in): 88 <sup>7</sup>/<sub>16</sub>

Light Distribution: Indirect  
 Fixture Finish: EWH / EBK / MAN / COF / PRD / SLF / GLF / CLF / BRL / EWS / EWG / EWC / EWR / EBS / EBG / EBC / EBC / EBB / MAS / MAD / MAC / MAB / COS / CGO / CCL / CBL / PRS / PRG / PRC / PRB

Fixture Material: Metal  
 Cable Details: 4 Steel Cable 2000mm / 78 3/4" - Silicon Cable 2000mm / 78 3/4"

### ELECTRICAL

Lamp Type: LED  
 Total Output Wattage (W): 20  
 Dimming: 0-10V Dimming / Phase Dimming (120Vac Only)  
 Driver Included: Yes  
 Driver Location: Integrated  
 Driver Type: Constant Voltage - Universal  
 Driver Class: Class 2  
 Input Voltage (V): 120 - 277  
 Output Voltage (V): 24  
 Upon Request: (Not included - see components) Remote: 0-10Vdc dimming / Phase dimming @120Vac only / (Included) Integral Non-dimming 277Vac

### LED

Color Temperature (°K): 3000  
 Max. Delivered Lumen (lm): 3000  
 CRI: >85 CRI  
 Lamp Life (hrs): 50000

### OPTICAL

### RATINGS AND CERTIFICATIONS

Certified By: CSA Certified to UL and CSA Standards  
 IP rating: IP20

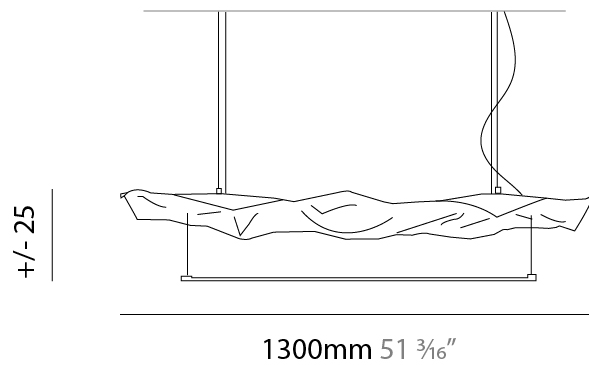

## CRASH SUSPENSION

D131557-

PROJECT

TYPE

SPECIFIER

QUANTITY

DATE



D

## CRASH SURFACE

**D132044-** \_\_\_\_\_  
base number

|           |
|-----------|
| PROJECT   |
| TYPE      |
| SPECIFIER |
| QUANTITY  |
| DATE      |

- To build a product code in our configurator select the specify button on the base model # product page
- To build a manual product code on this datasheet choose from the options listed below in blue font and add the suffix to the base model #

### GENERAL

Series: Crash  
 Brand: Knikerboker  
 Division: Design  
 Mounting Type: Surface  
 Mounting Location: Ceiling  
 Subcategory: Ambient

### PHYSICAL

Shape: Abstract  
 Length (mm): 1000  
 Length (in): 39 3/8  
 Width (mm): 400  
 Width (in): 15 3/4  
 Height (mm): 240  
 Height (in): 9 7/16  
 Extension (mm): 250  
 Extension (in): 9 13/16  
 Light Distribution: Indirect  
 Fixture Finish: EWH / EBK / MAN / COF / PRD / SLF / GLF / CLF / BRL / EWS / EWG / EWC / EWR / EBS / EBG / EBC / EBC / EBB / MAS / MAD / MAC / MAB / COS / CGO / CCL / CBL / PRS / PRG / PRC / PRB  
 Fixture Material: Metal

### ELECTRICAL

Lamp Type: LED  
 Input Wattage (W): 10.5  
 Total Output Wattage (W): 10  
 Dimming: Tri-Mode (Non-Dimming and Phase Dimming (120Vac only) and 0-10V Dimming)  
 Driver Included: Yes  
 Driver Location: Integrated  
 Driver Type: Constant Current - Universal  
 Driver Class: Class 2  
 Input Voltage (V): 120 - 277  
 Constant Current (MA): 250  
 Upon Request: 0-10Vdc dimming / Phase dimming @120Vac / 277Vac

### LED

Number of LEDs: 1  
 Color Temperature (°K): 3000  
 Max. Delivered Lumen (lm): 2200  
 CRI: >85 CRI  
 Lamp Life (hrs): 50000

### OPTICAL

#### RATINGS AND CERTIFICATIONS

Certified By: Certified for North American Standards  
 IP rating: IP20

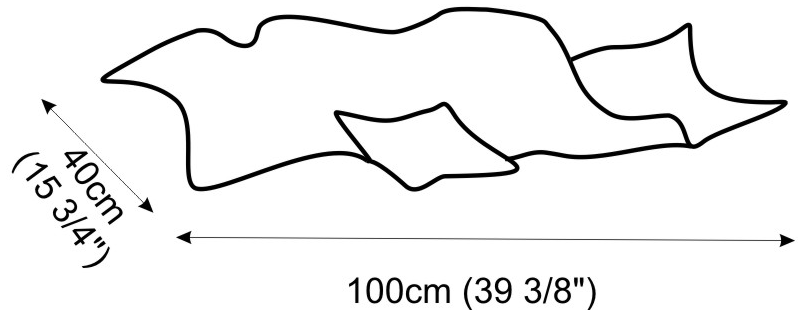

|           |       |
|-----------|-------|
| PROJECT   | _____ |
| TYPE      | _____ |
| SPECIFIER | _____ |
| QUANTITY  | _____ |
| DATE      | _____ |

## CRASH SURFACE

**D132047-** \_\_\_\_\_  
base number

1. To build a product code in our configurator select the specify button on the base model # product page
2. To build a manual product code on this datasheet choose from the options listed below in blue font and add the suffix to the base model #

### GENERAL

Series: Crash  
Brand: Knikerboker  
Division: Design  
Mounting Type: Surface  
Mounting Location: Ceiling

### PHYSICAL

Shape: Rectangle  
Length (mm): 300  
Length (in): 11 <sup>13</sup>/<sub>16</sub>  
Width (mm): 300  
Width (in): 11 <sup>13</sup>/<sub>16</sub>  
Light Distribution: Indirect  
Fixture Finish: EWH / EBK / MAN / COF / PRD / SLF / GLF / CLF / BRL / EWS / EWG / EWC / EWR / EBS / EBG / EBC / EBC / EBB / MAS / MAD / MAC / MAB / COS / CGO / CCL / CBL / PRS / PRG / PRC / PRB  
Fixture Material: Metal

### ELECTRICAL

Lamp Type: LED  
Input Wattage (W): 10.5  
Total Output Wattage (W): 10  
Dimming: Tri-Mode (Non-Dimming and Phase Dimming (120Vac only) and 0-10V Dimming)  
Driver Included: Yes  
Driver Location: Integrated  
Driver Type: Constant Current - Universal  
Driver Class: Class 2  
Input Voltage (V): 120 - 277  
Constant Current (MA): 250  
Upon Request: 0-10Vdc dimming / Phase dimming @120Vac only / 277Vac

### LED

Number of LEDs: 1  
Color Temperature (°K): 3000  
Max. Delivered Lumen (lm): 1100  
CRI: >85 CRI  
Lamp Life (hrs): 50000

### OPTICAL

#### RATINGS AND CERTIFICATIONS

Certified By: Certified for North American Standards  
IP rating: IP20

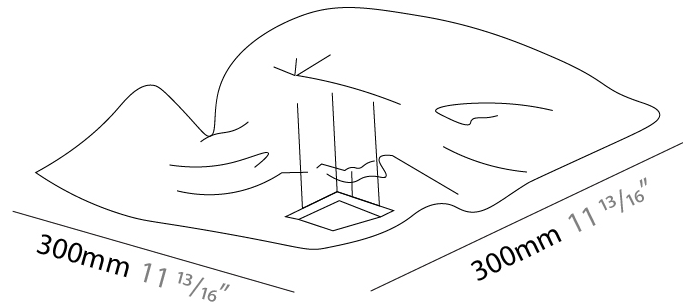

## CRASH SURFACE

D132047-

PROJECT

TYPE

SPECIFIER

QUANTITY

DATE



|           |       |
|-----------|-------|
| PROJECT   | _____ |
| TYPE      | _____ |
| SPECIFIER | _____ |
| QUANTITY  | _____ |
| DATE      | _____ |

## CRASH SURFACE

**D132050-** \_\_\_\_\_  
base number

1. To build a product code in our configurator select the specify button on the base model # product page
2. To build a manual product code on this datasheet choose from the options listed below in blue font and add the suffix to the base model #

### GENERAL

Series: Crash  
Brand: Knikerboker  
Division: Design  
Mounting Type: Surface  
Mounting Location: Ceiling

### PHYSICAL

Shape: Rectangle  
Length (mm): 500  
Length (in): 19 <sup>11</sup>/<sub>16</sub>  
Width (mm): 500  
Width (in): 19 <sup>11</sup>/<sub>16</sub>  
Height (mm): 300  
Height (in): 11 <sup>13</sup>/<sub>16</sub>  
Light Distribution: Indirect  
Fixture Finish: EWH / EBK / MAN / COF / PRD / SLF / GLF / CLF / BRL / EWS / EWG / EWC / EWR / EBS / EBG / EBC / EBC / EBB / MAS / MAD / MAC / MAB / COS / CGO / CCL / CBL / PRS / PRG / PRC / PRB  
Fixture Material: Metal

### ELECTRICAL

Lamp Type: LED  
Input Wattage (W): 21  
Total Output Wattage (W): 20  
Dimming: Tri-Mode (Non-Dimming and Phase Dimming (120Vac only) and 0-10V Dimming)  
Driver Included: Yes  
Driver Location: Integrated  
Driver Type: Constant Current - Universal  
Driver Class: Class 2  
Input Voltage (V): 120 - 277  
Constant Current (MA): 250

### LED

Number of LEDs: 2  
Color Temperature (°K): 3000  
Max. Delivered Lumen (lm): 2200  
CRI: >85 CRI  
Lamp Life (hrs): 50000

### OPTICAL

#### RATINGS AND CERTIFICATIONS

Certified By: Certified for North American Standards  
IP rating: IP20

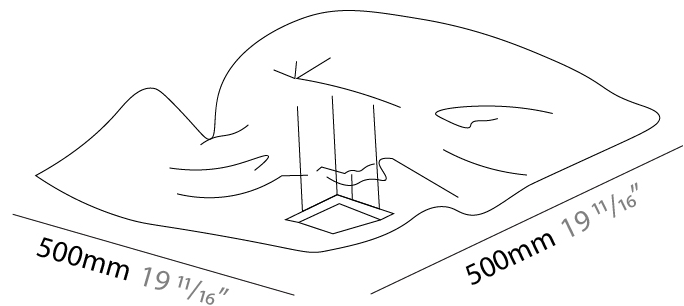



|           |       |
|-----------|-------|
| PROJECT   | _____ |
| TYPE      | _____ |
| SPECIFIER | _____ |
| QUANTITY  | _____ |
| DATE      | _____ |

## CRASH SURFACE

**D132053-** \_\_\_\_\_  
base number

- To build a product code in our configurator select the specify button on the base model # product page
- To build a manual product code on this datasheet choose from the options listed below in blue font and add the suffix to the base model #

### GENERAL

Series: Crash  
 Brand: Knikerboker  
 Division: Design  
 Mounting Type: Surface  
 Mounting Location: Ceiling

### PHYSICAL

Shape: Rectangle  
 Length (mm): 750  
 Length (in): 29 1/2  
 Width (mm): 750  
 Width (in): 29 1/2  
 Extension (mm): 150  
 Extension (in): 5 7/8  
 Light Distribution: Indirect  
 Fixture Finish: EWH / EBK / MAN / COF / PRD / SLF / GLF / CLF / BRL / EWS / EWG / EWC / EWR / EBS / EBG / EBC / EBC / EBB / MAS / MAD / MAC / MAB / COS / CGO / CCL / CBL / PRS / PRG / PRC / PRB  
 Fixture Material: Metal

### ELECTRICAL

Lamp Type: LED  
 Input Wattage (W): 21  
 Total Output Wattage (W): 20  
 Dimming: Tri-Mode (Non-Dimming and Phase Dimming (120Vac only) and 0-10V Dimming)  
 Driver Included: Yes  
 Driver Location: Integrated  
 Driver Type: Constant Current - Universal  
 Driver Class: Class 2  
 Input Voltage (V): 120 - 277  
 Constant Current (MA): 250  
 Upon Request: 0-10Vdc dimming / Phase dimming @120Vac / 277Vac

### LED

Number of LEDs: 2  
 Color Temperature (°K): 3000  
 Max. Delivered Lumen (lm): 1100  
 CRI: >85 CRI  
 Lamp Life (hrs): 50000

### OPTICAL

#### RATINGS AND CERTIFICATIONS

Certified By: Certified for North American Standards  
 IP rating: IP20

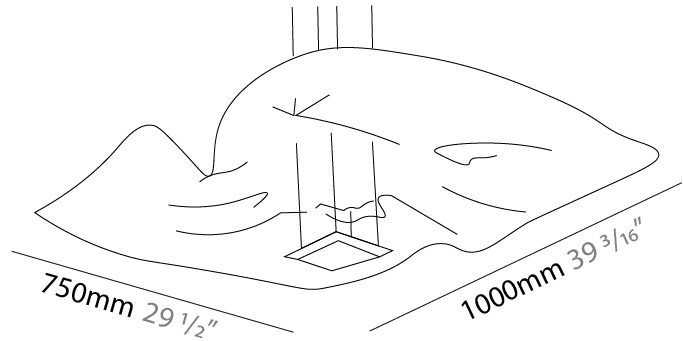

## CRASH SURFACE

D132053-

PROJECT \_\_\_\_\_

TYPE \_\_\_\_\_

SPECIFIER \_\_\_\_\_

QUANTITY \_\_\_\_\_

DATE \_\_\_\_\_

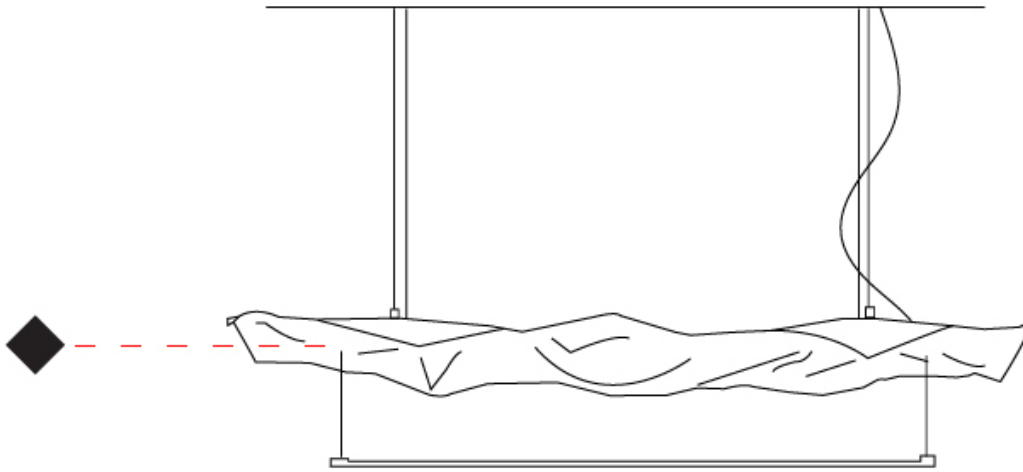

D

|           |       |
|-----------|-------|
| PROJECT   | _____ |
| TYPE      | _____ |
| SPECIFIER | _____ |
| QUANTITY  | _____ |
| DATE      | _____ |

## CRASH SURFACE

**D132056-** \_\_\_\_\_  
base number

- To build a product code in our configurator select the specify button on the base model # product page
- To build a manual product code on this datasheet choose from the options listed below in blue font and add the suffix to the base model #

### GENERAL

Series: Crash  
 Brand: Knikerboker  
 Division: Design  
 Mounting Type: Surface  
 Mounting Location: Ceiling

### PHYSICAL

Shape: Rectangle  
 Length (mm): 1000  
 Length (in): 39 <sup>3</sup>/<sub>8</sub>  
 Width (mm): 1000  
 Width (in): 39 <sup>3</sup>/<sub>8</sub>  
 Height (mm): 250  
 Height (in): 9 <sup>13</sup>/<sub>16</sub>  
 Light Distribution: Indirect  
 Fixture Finish: EWH / EBK / MAN / COF / PRD / SLF / GLF / CLF / BRL / EWS / EWG / EWC / EWR / EBS / EBG / EBC / EBC / EBB / MAS / MAD / MAC / MAB / COS / CGO / CCL / CBL / PRS / PRG / PRC / PRB  
 Fixture Material: Metal

### ELECTRICAL

Lamp Type: LED  
 Input Wattage (W): 21  
 Total Output Wattage (W): 20  
 Dimming: Tri-Mode (Non-Dimming and Phase Dimming (120Vac only) and 0-10V Dimming)  
 Driver Included: Yes  
 Driver Location: Integrated  
 Driver Type: Constant Current - Universal  
 Driver Class: Class 2  
 Input Voltage (V): 120 - 277  
 Constant Current (MA): 250  
 Upon Request: 0-10Vdc dimming / Phase dimming @120Vac / 277Vac

### LED

Number of LEDs: 2  
 Color Temperature (°K): 3000  
 Max. Delivered Lumen (lm): 1100  
 CRI: >85 CRI  
 Lamp Life (hrs): 50000

### OPTICAL

#### RATINGS AND CERTIFICATIONS

Certified By: Certified for North American Standards  
 IP rating: IP20

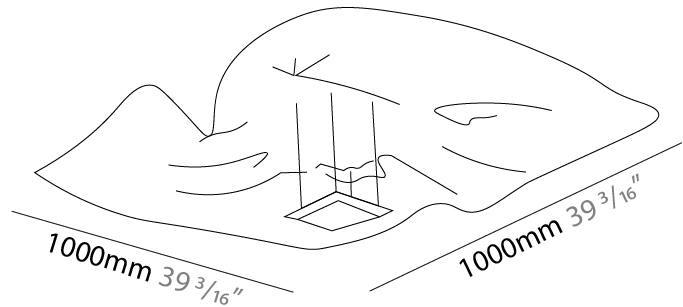

|           |
|-----------|
| PROJECT   |
| TYPE      |
| SPECIFIER |
| QUANTITY  |
| DATE      |

## CRASH SURFACE

**D132109-** \_\_\_\_\_  
base number

- To build a product code in our configurator select the specify button on the base model # product page
- To build a manual product code on this datasheet choose from the options listed below in blue font and add the suffix to the base model #

### GENERAL

Series: Crash  
 Brand: Knikerboker  
 Division: Design  
 Mounting Type: Surface  
 Mounting Location: Ceiling  
 Subcategory: Pendant

### PHYSICAL

Shape: Abstract  
 Length (mm): 200  
 Length (in): 7 7/8  
 Width (mm): 200  
 Width (in): 7 7/8  
 Height (mm): 250  
 Height (in): 9 13/16  
 Light Distribution: Indirect  
 Fixture Finish: EWH / EBK / MAN / COF / PRD / SLF / GLF / CLF / BRL / EWS / EWG / EWC / EWR / EBS / EBG / EBC / EBB / MAS / MAD / MAC / MAB / COS / CGO / CCL / CBL / PRS / PRG / PRC / PRB  
 Fixture Material: Metal

### ELECTRICAL

Lamp Type: LED  
 Input Wattage (W): 10.5  
 Total Output Wattage (W): 10  
 Dimming: Tri-Mode (Non-Dimming and Phase Dimming (120Vac only) and 0-10V Dimming)  
 Driver Included: Yes  
 Driver Location: Integrated  
 Driver Type: Constant Current - Universal  
 Driver Class: Class 2  
 Input Voltage (V): 120 - 277  
 Constant Current (MA): 250  
 Upon Request: 0-10Vdc Dimming / Phase dimming @120Vac only / Non-dimming 120/277Vac

### LED

Number of LEDs: 1  
 Color Temperature (°K): 3000  
 Max. Delivered Lumen (lm): 1100  
 CRI: >85 CRI  
 Lamp Life (hrs): 50000

### OPTICAL

### RATINGS AND CERTIFICATIONS

Certified By: Certified for North American Standards  
 IP rating: IP20

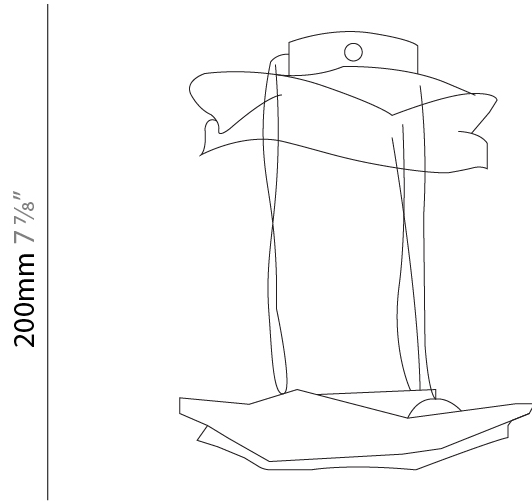
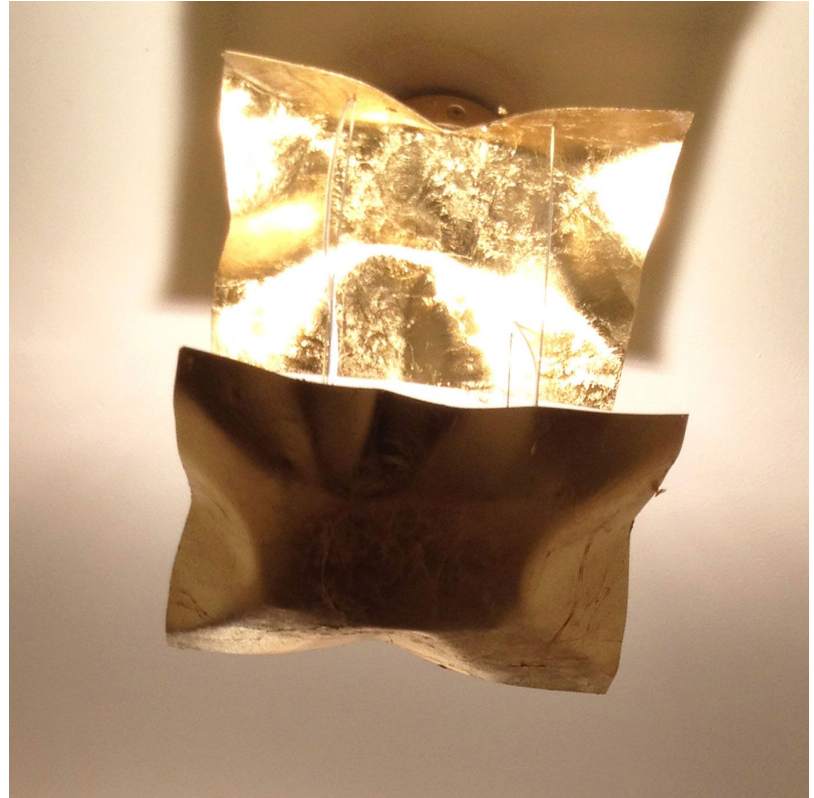

200mm 7 7/8"

200mm 7 7/8"



## CRASH SURFACE

D132109-

|           |       |
|-----------|-------|
| PROJECT   | _____ |
| TYPE      | _____ |
| SPECIFIER | _____ |
| QUANTITY  | _____ |
| DATE      | _____ |

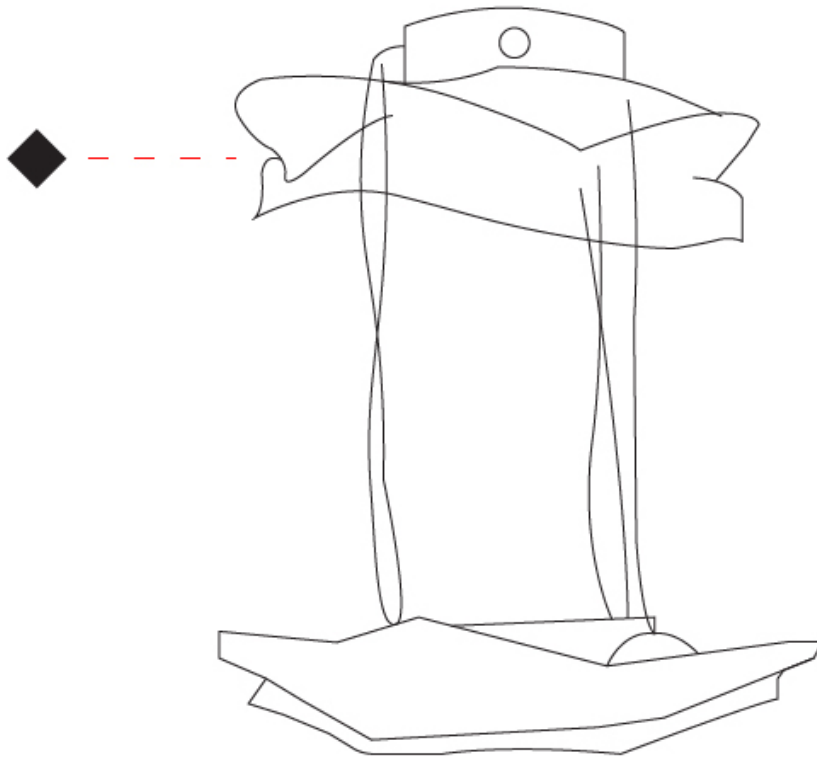

D

|           |
|-----------|
| PROJECT   |
| TYPE      |
| SPECIFIER |
| QUANTITY  |
| DATE      |

## CRASH SURFACE

### D132139-

base number                      Finish                       
Options                     

- To build a product code in our configurator select the specify button on the base model # product page
- To build a manual product code on this datasheet choose from the options listed below in blue font and add the suffix to the base model #

#### GENERAL

Series: Crash  
 Brand: Knikerboker  
 Division: Design  
 Mounting Type: Surface  
 Mounting Location: Wall

#### PHYSICAL

Shape: Rectangle  
 Length (mm): 600  
 Length (in): 23 <sup>5</sup>/<sub>8</sub>  
 Width (mm): 250  
 Width (in): 9 <sup>13</sup>/<sub>16</sub>  
 Height (mm): 120  
 Height (in): 4 <sup>3</sup>/<sub>4</sub>  
 Light Distribution: Indirect  
 Fixture Finish: EWH / EBK / MAN / COF / PRD / SLF / GLF / CLF / BRL  
 Fixture Material: Metal

#### ELECTRICAL

Lamp Type: LED  
 Total Output Wattage (W): 6  
 Dimming: 0-10V Dimming / Phase Dimming (120Vac Only)  
 Driver Included: Yes  
 Driver Location: Integrated  
 Driver Type: Constant Voltage - Universal - Non-dimming  
 Driver Class: Class 2  
 Input Voltage (V): 120 - 277  
 Output Voltage (V): 24  
 Upon Request: (Not included - see components) Remote: 0-10Vdc dimming / Phase dimming @120Vac only

#### LED

Number of LEDs: 1 strip  
 Color Temperature (°K): 3000  
 Max. Delivered Lumen (lm): 1100  
 CRI: >85 CRI  
 Lamp Life (hrs): 50000  
 Upon Request: 2700K

#### OPTICAL

#### RATINGS AND CERTIFICATIONS

Certified By: Certified for North American Standards  
 IP rating: IP20

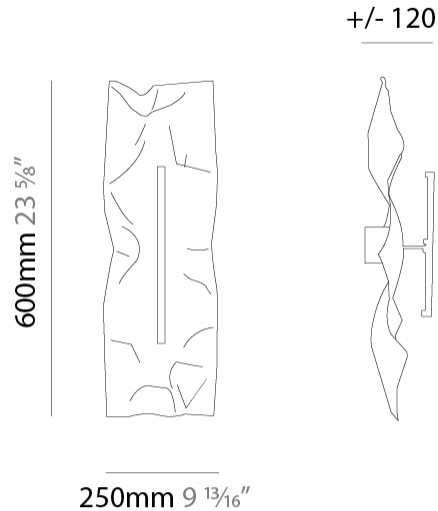

## CRASH SURFACE

D132139-

PROJECT

TYPE

SPECIFIER

QUANTITY

DATE



|           |       |
|-----------|-------|
| PROJECT   | _____ |
| TYPE      | _____ |
| SPECIFIER | _____ |
| QUANTITY  | _____ |
| DATE      | _____ |

## CRASH SURFACE

### D133000-

base number            Finish             
Options           

- To build a product code in our configurator select the specify button on the base model # product page
- To build a manual product code on this datasheet choose from the options listed below in blue font and add the suffix to the base model #

#### GENERAL

Series: Crash  
 Brand: Knikerboker  
 Division: Design  
 Mounting Type: Surface  
 Mounting Location: Wall  
 Subcategory: Ambient

#### PHYSICAL

Shape: Square  
 Length (mm): 750  
 Length (in): 29 1/2  
 Width (mm): 750  
 Width (in): 29 1/2  
 Extension (mm): 260  
 Extension (in): 10 1/4  
 Light Distribution: Indirect  
 Fixture Finish: EWH / EBK / MAN / COF / PRD / SLF / GLF / CLF / BRL  
 Fixture Material: Metal

#### ELECTRICAL

Lamp Type: LED  
 Input Wattage (W): 10.5  
 Total Output Wattage (W): 10  
 Dimming: Tri-Mode (Non-Dimming and Phase Dimming (120Vac only) and 0-10V Dimming)  
 Driver Included: Yes  
 Driver Location: Integrated  
 Driver Type: Constant Current - Universal  
 Driver Class: Class 2  
 Input Voltage (V): 120 - 277  
 Constant Current (MA): 250  
 Upon Request: 0-10Vdc dimming / Phase dimming @120Vac only / Non-dimming 120/277Vac

#### LED

Number of LEDs: 1  
 Color Temperature (°K): 3000  
 Max. Delivered Lumen (lm): 1100  
 CRI: >85 CRI  
 Lamp Life (hrs): 50000

#### OPTICAL

#### RATINGS AND CERTIFICATIONS

Certified By: Certified for North American Standards  
 IP rating: IP20

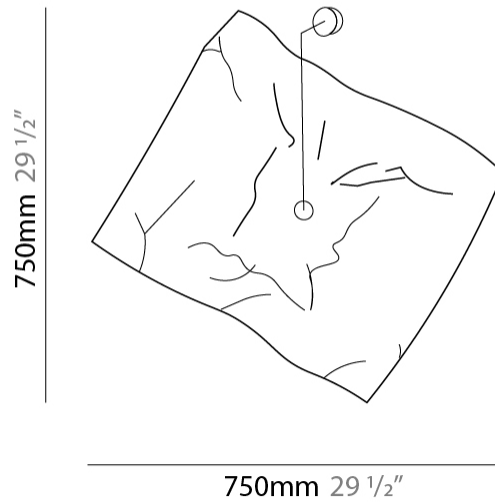



## CRASH SURFACE

### D133003-

base number                      Finish                       
Options                     

1. To build a product code in our configurator select the specify button on the base model # product page
2. To build a manual product code on this datasheet choose from the options listed below in blue font and add the suffix to the base model #

#### GENERAL

Series: Crash                       
Brand: Knikerboker                       
Division: Design                       
Mounting Type: Surface                       
Mounting Location: Wall                       
Subcategory: Ambient                     

#### PHYSICAL

Shape: Rectangle                       
Length (mm): 1000                       
Length (in): 39 <sup>3</sup>/<sub>8</sub>                       
Height (mm): 1000                       
Height (in): 39 <sup>3</sup>/<sub>8</sub>                       
Extension (mm): 260                       
Extension (in): 10 <sup>1</sup>/<sub>4</sub>                       
Light Distribution: Indirect                       
[Fixture Finish: EWH / EBK / MAN / COF / PRD / SLF / GLF / CLF / BRL](#)                       
Fixture Material: Metal                     

#### ELECTRICAL

Lamp Type: LED                       
Input Wattage (W): 10.5                       
Total Output Wattage (W): 10                       
Dimming: Tri-Mode (Non-Dimming and Phase Dimming (120Vac only and 0-10V Dimming)                       
Driver Included: Yes                       
Driver Location: Integrated                       
Driver Type: Constant Current - Universal                       
Driver Class: Class 2                       
Input Voltage (V): 120 - 277                       
Constant Current (MA): 250                       
Upon Request: 0-10Vdc dimming / Phase dimming @120Vac / 277Vac                     

#### LED

Number of LEDs: 1                       
Color Temperature (°K): 3000                       
Max. Delivered Lumen (lm): 1100                       
CRI: >85 CRI                       
Lamp Life (hrs): 50000                     

#### OPTICAL

#### RATINGS AND CERTIFICATIONS

Certified By: Certified for North American Standards                       
IP rating: IP20                     

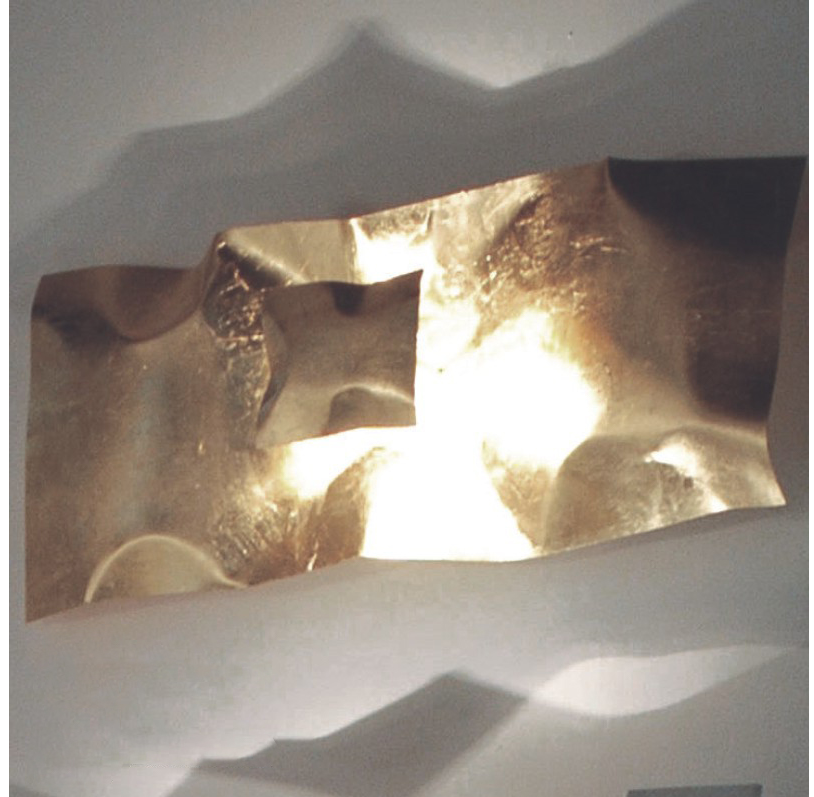

## CRASH

### COLOR FINISH CHART

#### Fixture Finish

Embossed White - EWH



Embossed Black - EBK

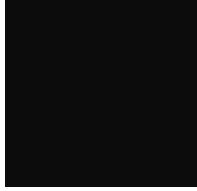

Metallic Anthracite - MAN

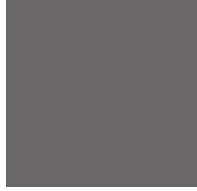

Coffee - COF

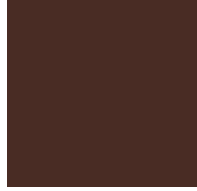

Purple Red - PRD



Silver Leaf - SLF

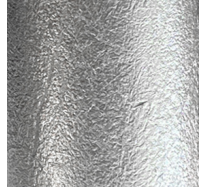

Gold Leaf - GLF



Copper Leaf - CLF

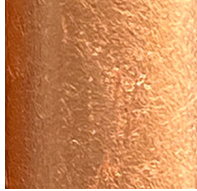

Bronze Leaf - BRL

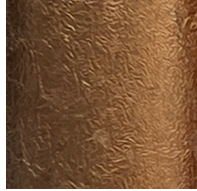

Metallic Anthracite / Silver Leaf - MAS

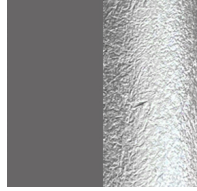

Metallic Anthracite / Gold Leaf - MAD

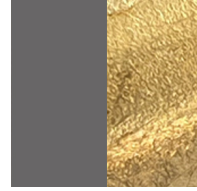

Metallic Anthracite / Copper Leaf - MAC



Metallic Anthracite / Bronze Leaf - MAB

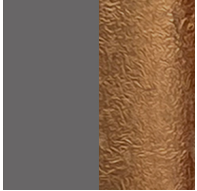

Coffee / Silver Leaf - COS

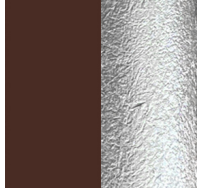

Coffee / Gold Leaf - CGO

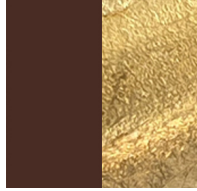

Coffee / Copper Leaf - CCL



Coffee / Bronze Leaf - CBL



Purple Red / Silver Leaf - PRS

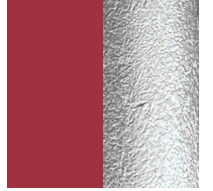

Purple Red / Gold Leaf - PRG

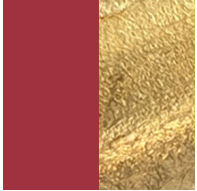

Purple Red / Copper Leaf - PRC

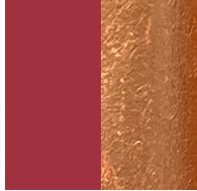

Purple Red / Bronze Leaf - PRB



**Digital:** Not all screens are calibrated the same, and therefore, colors will appear differently between screens.

**Physical:** When texture is involved, there will be variations in color, character and tone within a product series and between product families.



|           |  |
|-----------|--|
| PROJECT   |  |
| TYPE      |  |
| SPECIFIER |  |
| QUANTITY  |  |
| DATE      |  |

### LEGEND

|  |   |  |  |  |  |
|--|---|--|--|--|--|
|  | floor-mounted   |  | pivotable  |  | special LED (upon request) RGB, RGBW, tunable, gold+, meat+, art+, fashion+                    |
|  | wall and ceiling: recessed and surface mounted            |  | rotating   |  | warm dim / natural dimming LED   |
|  | ceiling-mounted and wall-mounted                          |  | illuminate tilted  |  | rechargeable battery powered   |
|  | wall-mounted  |  | color of suspension cable                                    |  | fixture with natural vivid LED (upon request)  |
|  | omni-directional light distribution                       |  | length of suspension cable                                   |  | color rendering index  |
|  | direct light distribution                                 |  | reflector degree selection                                   |  | color temperature  |
|  | direct/indirect light distribution                        |  | super spot   |  | lumen (luminous flux)  |
|  | indirect light distribution                               |  | lens   |  | efficacy (lumens per watt)   |
|  | asymmetric light distribution                             |  | lens pack  |  | Unified Glare Rating (UGR) range from 5-40   |
|  | aura light distribution                                   |  | shine ring   |  | marine grade (AISI 316 stainless steel)  |
|  | round wall or ceiling cut-out                             |  | integrated shine ring with diffuser                          |  | walk on  |
|  | square wall or ceiling cut-out                            |  | free individual colors 01-29                                 |  | drive on   |
|  | the supplied jig specifies the cutout dimensions          |  | individual colors: 00 (free of charge), 01-25 (extra charge) |  | Dark Sky Compliance  |
|  | minimum distance (meters) lamp - object                   |  | luminaire part to be colored (F1)                            |  | Americans with Disabilities Act (less than 4" off the wall located between 27"-84" from floor) |
|  | recessed depth  |  | luminaire part to be colored (F2)                            |  | lamp protected against explosion   |
|  | ceiling thickness in mm                                   |  | luminaire part to be colored (F3)                            |  | blown glass using traditional methods by master glass blower                                   |
|  | ceiling thickness selection                               |  | luminaire part to be colored (F4)                            |  | acoustic material  |
|  | dimmable DP (phase), DV (0-10V), DD (dali), DS (step-dim) |  | luminaire part to be colored (F5)                            |  | protection class I, protection insulation  |
|  | included or excluded LED driver/transformer/control gear  |  | color of 3-circuit adaptor                                   |  | protection class II, protection insulation   |
|  | separately switchable                                     |  | indirect diffuser  |  | ETL Certified to UL and CSA Standards  |
|  | sensor  |  | direct diffuser  |  | UL Certified to UL and CSA Standards   |
|  | remote control  |  | ball-proof (upon request)                                    |  | CSA Certified to UL and CSA Standards  |
|  | available upon request                                    |  | accessory  |  | Certified for North American Standards   |

### IP RATING

|  |  |
|--|--|
|  | protected against ingress of solid bodies greater than 12.5mm (finger)   |
|  | protected against ingress of solid bodies greater than 2.5mm<br>protected against sprays of water up to 60 degrees from the vertical (rain)      |
|  | protected against ingress of solid bodies greater than 1mm (wire)<br>no protection against the ingress of moisture                               |
|  | protected against ingress of solid bodies greater than 1mm (wire)<br>protected against sprays of water up to 60 degrees from the vertical (rain) |
|  | protected against ingress of solid bodies greater than 1mm (wire)<br>protected against water splashed from all directions                        |
|  | protected against limited ingress of dust (wet rooms/covered outdoor areas)<br>protected against water splashed from all directions              |
|  | protected against ingress of dust<br>protected against jets of water   |
|  | protected against ingress of dust<br>protected against powerful jets of water or heavy seas  |
|  | protected against ingress of dust<br>protected against immersion of water between 15cm - 1m for 30 minutes                                       |
|  | protected against ingress of dust<br>protected against immersion of water under pressure for long periods  |

### IK RATING

|  |   |
|--|---|
|  | protected against 0.14 joules impact (equivalent to 0.25kg mass dropped from 56mm above the surface)  |
|  | protected against 0.2 joules impact (equivalent to 0.25kg mass dropped from 80mm above the surface)   |
|  | protected against 0.35 joules impact (equivalent to 0.25kg mass dropped from 140mm above the surface) |
|  | protected against 0.5 joules impact (equivalent to 0.25kg mass dropped from 200mm above the surface)  |
|  | protected against 0.7 joules impact (equivalent to 0.25kg mass dropped from 280mm above the surface)  |
|  | protected against 1 joules impact (equivalent to 0.25kg mass dropped from 400mm above the surface)    |
|  | protected against 2 joules impact (equivalent to 0.5kg mass dropped from 400mm above the surface)     |
|  | protected against 5 joules impact (equivalent to 1.7kg mass dropped from 300mm above the surface)     |
|  | protected against 10 joules impact (equivalent to 5.0kg mass dropped from 200mm above the surface)    |
|  | protected against 20 joules impact (equivalent to 5.0kg mass dropped from 400mm above the surface)    |