

## CRASH SUSPENSION

**D131065-** \_\_\_\_\_  
 base number

- To build a product code in our configurator select the specify button on the base model # product page
- To build a manual product code on this datasheet choose from the options listed below in blue font and add the suffix to the base model #

### GENERAL

Series: Crash  
 Brand: Knikerboker  
 Division: Design  
 Mounting Type: Suspension  
 Mounting Location: Ceiling  
 Subcategory: Pendant

### PHYSICAL

Shape: Abstract  
 Length (mm): 1000  
 Length (in): 39 <sup>3</sup>/<sub>16</sub>  
 Width (mm): 1000  
 Width (in): 39 <sup>3</sup>/<sub>16</sub>  
 Max. Overall Height (mm): 2000  
 Max. Overall Height (in): 78 <sup>3</sup>/<sub>4</sub>  
 Light Distribution: Indirect  
 Fixture Finish: EWH / EBK / MAN / COF / PRD / SLF / GLF / CLF / BRL / EWS / EWG / EWC / EWR / EBS / EBG / EBC / EBC / EBB / MAS / MAD / MAC / MAB / COS / CGO / CCL / CBL / PRS / PRG / PRC / PRB  
 Fixture Material: Metal  
 Cable Details: 4 Steel Cable 2000mm / 78 3/4" - Silicon Cable 2000mm / 78 3/4"

### ELECTRICAL

Lamp Type: LED Retrofit  
 Input Wattage (W): 21  
 Total Output Wattage (W): 20  
 Dimming: Tri-Mode (Non-Dimming and Phase Dimming (120Vac only) and 0-10V Dimming)  
 Driver Included: Yes  
 Driver Location: Integrated  
 Driver Type: Constant Current - Universal  
 Driver Class: Class 2  
 Input Voltage (V): 120 - 277  
 Constant Current (MA): 250  
 Upon Request: 0-10Vdc dimming / Phase dimming @120Vac / 277Vac

### LED

Number of LEDs: 2  
 Color Temperature (°K): 3000  
 Max. Delivered Lumen (lm): 2200  
 CRI: >85 CRI  
 Lamp Life (hrs): 50000

### OPTICAL

### RATINGS AND CERTIFICATIONS

Certified By: Certified for North American Standards  
 IP rating: IP20



## CRASH SUSPENSION

D131065-

PROJECT \_\_\_\_\_

TYPE \_\_\_\_\_

SPECIFIER \_\_\_\_\_

QUANTITY \_\_\_\_\_

DATE \_\_\_\_\_



D

## CRASH SUSPENSION

**D131068-** \_\_\_\_\_  
base number

PROJECT
TYPE
SPECIFIER
QUANTITY
DATE

- To build a product code in our configurator select the specify button on the base model # product page
- To build a manual product code on this datasheet choose from the options listed below in blue font and add the suffix to the base model #

### GENERAL

Series: Crash  
 Brand: Knikerboker  
 Division: Design  
 Mounting Type: Suspension  
 Mounting Location: Ceiling  
 Subcategory: Pendant

### PHYSICAL

Shape: Curves  
 Length (mm): 1500  
 Length (in): 59 1/16  
 Width (mm): 1500  
 Width (in): 59 1/16  
 Max. Overall Height (mm): 2000  
 Max. Overall Height (in): 78 3/4  
 Light Distribution: Indirect  
 Fixture Finish: EWH / EBK / MAN / COF / PRD / SLF / GLF / CLF / BRL / EWS / EWG / EWC / EWR / EBS / EBG / EBC / EBC / EBB / MAS / MAD / MAC / MAB / COS / CGO / CCL / CBL / PRS / PRG / PRC / PRB  
 Fixture Material: Metal  
 Cable Details: 4 Steel Cable 2000mm / 78 3/4" - Silicon Cable 2000mm / 78 3/4"

### ELECTRICAL

Lamp Type: LED  
 Input Wattage (W): 31.5  
 Total Output Wattage (W): 30  
 Dimming: Tri-Mode (Non-Dimming and Phase Dimming (120Vac only) and 0-10V Dimming)  
 Driver Included: Yes  
 Driver Location: Integrated  
 Driver Type: Constant Current - Universal  
 Driver Class: Class 2  
 Input Voltage (V): 120 - 277  
 Constant Current (MA): 250  
 Upon Request: 0-10Vdc dimming / Phase dimming @120Vac / 277Vac

### LED

Number of LEDs: 3  
 Color Temperature (°K): 3000  
 Max. Delivered Lumen (lm): 3300  
 CRI: >85 CRI  
 Lamp Life (hrs): 50000

### OPTICAL

### RATINGS AND CERTIFICATIONS

Certified By: Certified for North American Standards  
 IP rating: IP20

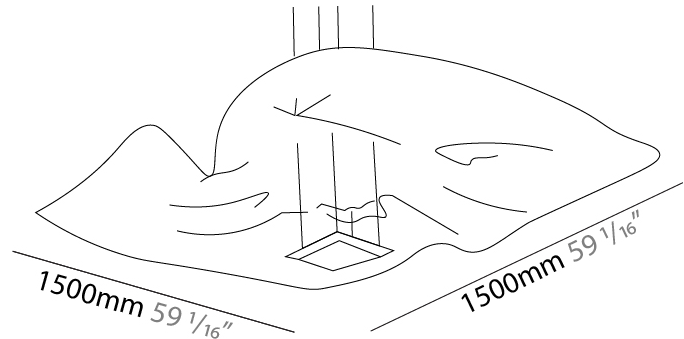

## CRASH SUSPENSION

D131068-

PROJECT \_\_\_\_\_

TYPE \_\_\_\_\_

SPECIFIER \_\_\_\_\_

QUANTITY \_\_\_\_\_

DATE \_\_\_\_\_



D

## CRASH SUSPENSION

**D131071-** \_\_\_\_\_  
 base number

- To build a product code in our configurator select the specify button on the base model # product page
- To build a manual product code on this datasheet choose from the options listed below in blue font and add the suffix to the base model #

### GENERAL

Series: Crash  
 Brand: Knikerboker  
 Division: Design  
 Mounting Type: Suspension  
 Mounting Location: Ceiling  
 Subcategory: Pendant

### PHYSICAL

Shape: Curves  
 Length (mm): 2500  
 Length (in): 98 <sup>7</sup>/<sub>16</sub>  
 Width (mm): 620  
 Width (in): 24 <sup>7</sup>/<sub>16</sub>  
 Max. Overall Height (mm): 2000  
 Max. Overall Height (in): 78 <sup>3</sup>/<sub>4</sub>  
 Light Distribution: Indirect  
 Fixture Finish: EWH / EBK / MAN / COF / PRD / SLF / GLF / CLF / BRL / EWS / EWG / EWC / EWR / EBS / EBG / EBC / EBC / EBB / MAS / MAD / MAC / MAB / COS / CGO / CCL / CBL / PRS / PRG / PRC / PRB  
 Fixture Material: Metal  
 Cable Details: 4 Steel Cable 2000mm / 78 3/4" - Silicon Cable 2000mm / 78 3/4"

### ELECTRICAL

Lamp Type: LED  
 Input Wattage (W): 42  
 Total Output Wattage (W): 40  
 Dimming: Tri-Mode (Non-Dimming and Phase Dimming (120Vac only) and 0-10V Dimming)  
 Driver Included: Yes  
 Driver Location: Integrated  
 Driver Type: Constant Current - Universal  
 Driver Class: Class 2  
 Input Voltage (V): 120 - 277  
 Constant Current (MA): 250  
 Upon Request: 0-10Vdc dimming / Phase dimming @120Vac / 277Vac

### LED

Number of LEDs: 4  
 Color Temperature (°K): 3000  
 Max. Delivered Lumen (lm): 4400  
 CRI: >85 CRI  
 Lamp Life (hrs): 50000

### OPTICAL

### RATINGS AND CERTIFICATIONS

Certified By: Certified for North American Standards  
 IP rating: IP20



## CRASH SUSPENSION

D131071-

PROJECT \_\_\_\_\_

TYPE \_\_\_\_\_

SPECIFIER \_\_\_\_\_

QUANTITY \_\_\_\_\_

DATE \_\_\_\_\_



D

PROJECT	_____
TYPE	_____
SPECIFIER	_____
QUANTITY	_____
DATE	_____

## CRASH SUSPENSION

**D131425-** \_\_\_\_\_  
base number

- To build a product code in our configurator select the specify button on the base model # product page
- To build a manual product code on this datasheet choose from the options listed below in blue font and add the suffix to the base model #

### GENERAL

Series: Crash  
 Brand: Knikerboker  
 Division: Design  
 Mounting Type: Suspension  
 Mounting Location: Ceiling  
 Subcategory: Pendant

### PHYSICAL

Shape: Abstract  
 Length (mm): 500  
 Length (in): 19 <sup>11</sup>/<sub>16</sub>  
 Width (mm): 500  
 Width (in): 19 <sup>11</sup>/<sub>16</sub>  
 Extension (mm): 2000  
 Extension (in): 78 <sup>3</sup>/<sub>4</sub>  
 Light Distribution: Indirect  
 Fixture Finish: EWH / EBK / MAN / COF / PRD / SLF / GLF / CLF / BRL / EWS / EWG / EWC / EWR / EBS / EBG / EBC / EBC / EBB / MAS / MAD / MAC / MAB / COS / CGO / CCL / CBL / PRS / PRG / PRC / PRB  
 Fixture Material: Metal  
 Cable Detail: 4 Steel Cable 2000mm / 78 3/4" - Silicon Cable 2000mm / 78 3/4"

### ELECTRICAL

Lamp Type: LED  
 Input Wattage (W): 10.5  
 Total Output Wattage (W): 10  
 Dimming: Tri-Mode (Non-Dimming and Phase Dimming (120Vac only) and 0-10V Dimming)  
 Driver Included: Yes  
 Driver Location: Integrated  
 Driver Type: Constant Current - Universal  
 Driver Class: Class 2  
 Input Voltage (V): 120 - 277  
 Constant Current (MA): 250  
 Upon Request: 0-10Vdc dimming / Phase dimming @120Vac / 277Vac

### LED

Color Temperature (°K): 3000  
 Max. Delivered Lumen (lm): 1100  
 CRI: >85 CRI  
 Lamp Life (hrs): 50000

### OPTICAL

### RATINGS AND CERTIFICATIONS

Certified By: Certified for North American Standards  
 IP rating: IP20

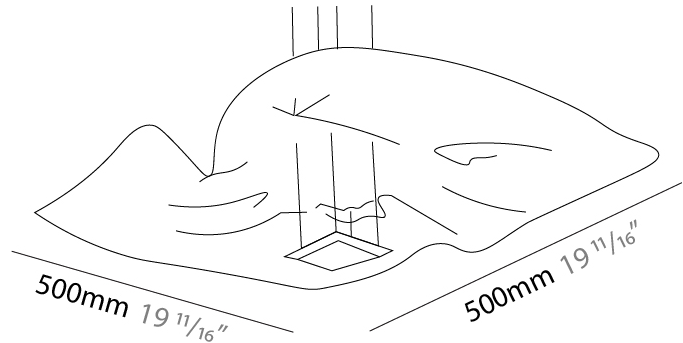

## CRASH SUSPENSION

D131425-

PROJECT	_____
TYPE	_____
SPECIFIER	_____
QUANTITY	_____
DATE	_____

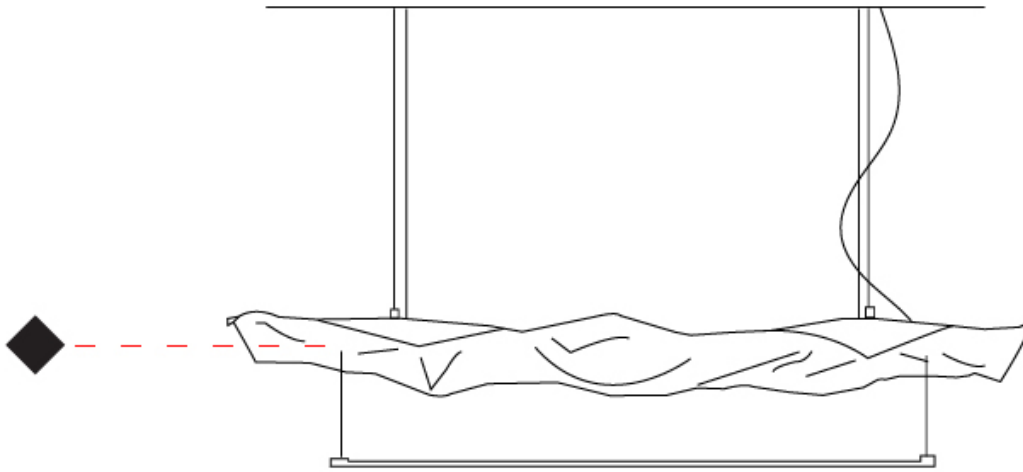

D



PROJECT	_____
TYPE	_____
SPECIFIER	_____
QUANTITY	_____
DATE	_____

## CRASH SUSPENSION

**D131439-** \_\_\_\_\_  
base number

- To build a product code in our configurator select the specify button on the base model # product page
- To build a manual product code on this datasheet choose from the options listed below in blue font and add the suffix to the base model #

### GENERAL

Series: Crash  
 Brand: Knikerboker  
 Division: Design  
 Mounting Type: Suspension  
 Mounting Location: Ceiling  
 Subcategory: Pendant

### PHYSICAL

Shape: Abstract  
 Length (mm): 1000  
 Length (in): 39 <sup>3</sup>/<sub>8</sub>  
 Width (mm): 750  
 Width (in): 29 <sup>1</sup>/<sub>2</sub>  
 Max. Overall Height (mm): 2000  
 Max. Overall Height (in): 78 <sup>3</sup>/<sub>4</sub>  
 Light Distribution: Indirect  
 Fixture Finish: EWH / EBK / MAN / COF / PRD / SLF / GLF / CLF / BRL / EWS / EWG / EWC / EWR / EBS / EBG / EBC / EBC / EBB / MAS / MAD / MAC / MAB / COS / CGO / CCL / CBL / PRS / PRG / PRC / PRB  
 Fixture Material: Metal  
 Cable Details: 4 Steel Cable 2000mm / 78 3/4" - Silicon Cable 2000mm / 78 3/4"

### ELECTRICAL

Lamp Type: LED  
 Input Wattage (W): 10.5  
 Total Output Wattage (W): 10  
 Dimming: Tri-Mode (Non-Dimming and Phase Dimming (120Vac only) and 0-10V Dimming)  
 Driver Included: Yes  
 Driver Location: Integrated  
 Driver Type: Constant Current - Universal  
 Driver Class: Class 2  
 Input Voltage (V): 120 - 277  
 Constant Current (MA): 250  
 Upon Request: 0-10Vdc dimming / Phase dimming @120Vac / 277Vac

### LED

Number of LEDs: 1  
 Color Temperature (°K): 3000  
 Max. Delivered Lumen (lm): 2200  
 CRI: >85 CRI  
 Lamp Life (hrs): 50000

### OPTICAL

### RATINGS AND CERTIFICATIONS

Certified By: Certified for North American Standards  
 IP rating: IP20

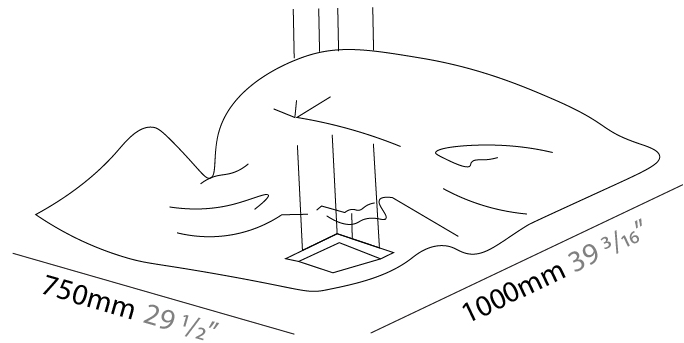

## CRASH SUSPENSION

D131439-

PROJECT

TYPE

SPECIFIER

QUANTITY

DATE



D

PROJECT	_____
TYPE	_____
SPECIFIER	_____
QUANTITY	_____
DATE	_____

## CRASH SUSPENSION

**D131557-** \_\_\_\_\_  
base number

- To build a product code in our configurator select the specify button on the base model # product page
- To build a manual product code on this datasheet choose from the options listed below in blue font and add the suffix to the base model #

### GENERAL

Series: Crash  
 Brand: Knikerboker  
 Division: Design  
 Mounting Type: Suspension  
 Mounting Location: Ceiling  
 Subcategory: Pendant

### PHYSICAL

Shape: Abstract  
 Length (mm): 1300  
 Length (in): 51 <sup>3</sup>/<sub>16</sub>  
 Width (mm): 400  
 Width (in): 15 <sup>3</sup>/<sub>4</sub>  
 Height (mm): 250  
 Height (in): 9 <sup>13</sup>/<sub>16</sub>  
 Max. Overall Height (mm): 2250  
 Max. Overall Height (in): 88 <sup>7</sup>/<sub>16</sub>

Light Distribution: Indirect  
 Fixture Finish: EWH / EBK / MAN / COF / PRD / SLF / GLF / CLF / BRL / EWS / EWG / EWC / EWR / EBS / EBG / EBC / EBC / EBB / MAS / MAD / MAC / MAB / COS / CGO / CCL / CBL / PRS / PRG / PRC / PRB

Fixture Material: Metal  
 Cable Details: 4 Steel Cable 2000mm / 78 3/4" - Silicon Cable 2000mm / 78 3/4"

### ELECTRICAL

Lamp Type: LED  
 Total Output Wattage (W): 20  
 Dimming: 0-10V Dimming / Phase Dimming (120Vac Only)  
 Driver Included: Yes  
 Driver Location: Integrated  
 Driver Type: Constant Voltage - Universal  
 Driver Class: Class 2  
 Input Voltage (V): 120 - 277  
 Output Voltage (V): 24  
 Upon Request: (Not included - see components) Remote: 0-10Vdc dimming / Phase dimming @120Vac only / (Included) Integral Non-dimming 277Vac

### LED

Color Temperature (°K): 3000  
 Max. Delivered Lumen (lm): 3000  
 CRI: >85 CRI  
 Lamp Life (hrs): 50000

### OPTICAL

### RATINGS AND CERTIFICATIONS

Certified By: CSA Certified to UL and CSA Standards  
 IP rating: IP20

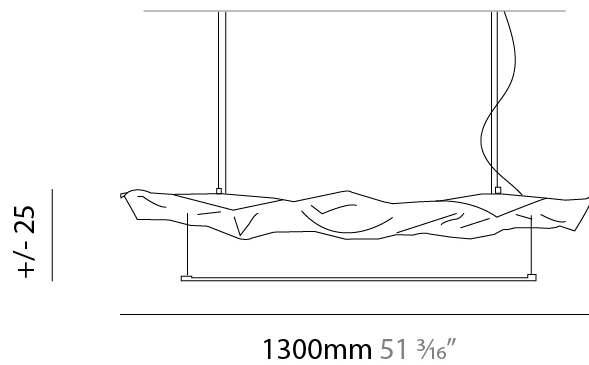

## CRASH SUSPENSION

D131557-

PROJECT \_\_\_\_\_

TYPE \_\_\_\_\_

SPECIFIER \_\_\_\_\_

QUANTITY \_\_\_\_\_

DATE \_\_\_\_\_



D

## CRASH SURFACE

**D132044-** \_\_\_\_\_  
base number

PROJECT
TYPE
SPECIFIER
QUANTITY
DATE

- To build a product code in our configurator select the specify button on the base model # product page
- To build a manual product code on this datasheet choose from the options listed below in blue font and add the suffix to the base model #

### GENERAL

Series: Crash  
 Brand: Knikerboker  
 Division: Design  
 Mounting Type: Surface  
 Mounting Location: Ceiling  
 Subcategory: Ambient

### PHYSICAL

Shape: Abstract  
 Length (mm): 1000  
 Length (in): 39 3/8  
 Width (mm): 400  
 Width (in): 15 3/4  
 Height (mm): 240  
 Height (in): 9 7/16  
 Extension (mm): 250  
 Extension (in): 9 13/16  
 Light Distribution: Indirect  
 Fixture Finish: EWH / EBK / MAN / COF / PRD / SLF / GLF / CLF / BRL / EWS / EWG / EWC / EWR / EBS / EBG / EBC / EBC / EBB / MAS / MAD / MAC / MAB / COS / CGO / CCL / CBL / PRS / PRG / PRC / PRB  
 Fixture Material: Metal

### ELECTRICAL

Lamp Type: LED  
 Input Wattage (W): 10.5  
 Total Output Wattage (W): 10  
 Dimming: Tri-Mode (Non-Dimming and Phase Dimming (120Vac only) and 0-10V Dimming)  
 Driver Included: Yes  
 Driver Location: Integrated  
 Driver Type: Constant Current - Universal  
 Driver Class: Class 2  
 Input Voltage (V): 120 - 277  
 Constant Current (MA): 250  
 Upon Request: 0-10Vdc dimming / Phase dimming @120Vac / 277Vac

### LED

Number of LEDs: 1  
 Color Temperature (°K): 3000  
 Max. Delivered Lumen (lm): 2200  
 CRI: >85 CRI  
 Lamp Life (hrs): 50000

### OPTICAL

### RATINGS AND CERTIFICATIONS

Certified By: Certified for North American Standards  
 IP rating: IP20

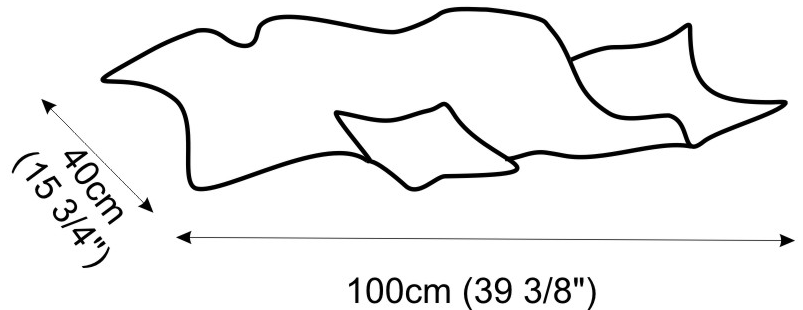

PROJECT	_____
TYPE	_____
SPECIFIER	_____
QUANTITY	_____
DATE	_____

## CRASH SURFACE

**D132047-** \_\_\_\_\_  
base number

- To build a product code in our configurator select the specify button on the base model # product page
- To build a manual product code on this datasheet choose from the options listed below in blue font and add the suffix to the base model #

### GENERAL

Series: Crash  
 Brand: Knikerboker  
 Division: Design  
 Mounting Type: Surface  
 Mounting Location: Ceiling

### PHYSICAL

Shape: Rectangle  
 Length (mm): 300  
 Length (in): 11 <sup>13</sup>/<sub>16</sub>  
 Width (mm): 300  
 Width (in): 11 <sup>13</sup>/<sub>16</sub>  
 Light Distribution: Indirect  
 Fixture Finish: EWH / EBK / MAN / COF / PRD / SLF / GLF / CLF / BRL / EWS / EWG / EWC / EWR / EBS / EBG / EBC / EBC / EBB / MAS / MAD / MAC / MAB / COS / CGO / CCL / CBL / PRS / PRG / PRC / PRB  
 Fixture Material: Metal

### ELECTRICAL

Lamp Type: LED  
 Input Wattage (W): 10.5  
 Total Output Wattage (W): 10  
 Dimming: Tri-Mode (Non-Dimming and Phase Dimming (120Vac only) and 0-10V Dimming)  
 Driver Included: Yes  
 Driver Location: Integrated  
 Driver Type: Constant Current - Universal  
 Driver Class: Class 2  
 Input Voltage (V): 120 - 277  
 Constant Current (MA): 250  
 Upon Request: 0-10Vdc dimming / Phase dimming @120Vac only / 277Vac

### LED

Number of LEDs: 1  
 Color Temperature (°K): 3000  
 Max. Delivered Lumen (lm): 1100  
 CRI: >85 CRI  
 Lamp Life (hrs): 50000

### OPTICAL

#### RATINGS AND CERTIFICATIONS

Certified By: Certified for North American Standards  
 IP rating: IP20

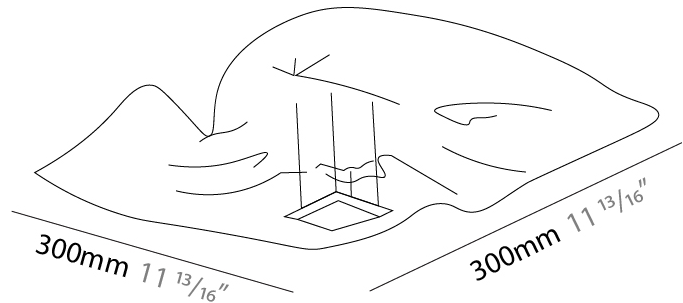

## CRASH SURFACE

D132047-

PROJECT

TYPE

SPECIFIER

QUANTITY

DATE



PROJECT	_____
TYPE	_____
SPECIFIER	_____
QUANTITY	_____
DATE	_____

## CRASH SURFACE

**D132050-** \_\_\_\_\_  
base number

- To build a product code in our configurator select the specify button on the base model # product page
- To build a manual product code on this datasheet choose from the options listed below in blue font and add the suffix to the base model #

### GENERAL

Series: Crash  
 Brand: Knikerboker  
 Division: Design  
 Mounting Type: Surface  
 Mounting Location: Ceiling

### PHYSICAL

Shape: Rectangle  
 Length (mm): 500  
 Length (in): 19 11/16  
 Width (mm): 500  
 Width (in): 19 11/16  
 Height (mm): 300  
 Height (in): 11 13/16  
 Light Distribution: Indirect  
 Fixture Finish: EWH / EBK / MAN / COF / PRD / SLF / GLF / CLF / BRL / EWS / EWG / EWC / EWR / EBS / EBG / EBC / EBC / EBB / MAS / MAD / MAC / MAB / COS / CGO / CCL / CBL / PRS / PRG / PRC / PRB  
 Fixture Material: Metal

### ELECTRICAL

Lamp Type: LED  
 Input Wattage (W): 21  
 Total Output Wattage (W): 20  
 Dimming: Tri-Mode (Non-Dimming and Phase Dimming (120Vac only) and 0-10V Dimming)  
 Driver Included: Yes  
 Driver Location: Integrated  
 Driver Type: Constant Current - Universal  
 Driver Class: Class 2  
 Input Voltage (V): 120 - 277  
 Constant Current (MA): 250

### LED

Number of LEDs: 2  
 Color Temperature (°K): 3000  
 Max. Delivered Lumen (lm): 2200  
 CRI: >85 CRI  
 Lamp Life (hrs): 50000

### OPTICAL

#### RATINGS AND CERTIFICATIONS

Certified By: Certified for North American Standards  
 IP rating: IP20

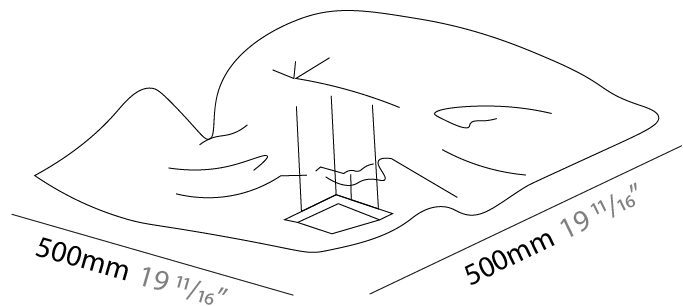



## CRASH SURFACE

### D132053- \_\_\_\_\_

base number

1. To build a product code in our configurator select the specify button on the base model # product page
2. To build a manual product code on this datasheet choose from the options listed below in blue font and add the suffix to the base model #

#### GENERAL

Series: Crash \_\_\_\_\_  
Brand: Knikerboker \_\_\_\_\_  
Division: Design \_\_\_\_\_  
Mounting Type: Surface \_\_\_\_\_  
Mounting Location: Ceiling \_\_\_\_\_

#### PHYSICAL

Shape: Rectangle \_\_\_\_\_  
Length (mm): 750 \_\_\_\_\_  
Length (in): 29 1/2 \_\_\_\_\_  
Width (mm): 750 \_\_\_\_\_  
Width (in): 29 1/2 \_\_\_\_\_  
Extension (mm): 150 \_\_\_\_\_  
Extension (in): 5 7/8 \_\_\_\_\_  
Light Distribution: Indirect \_\_\_\_\_  
Fixture Finish: EWH / EBK / MAN / COF / PRD / SLF / GLF / CLF / BRL / EWS / EWG / EWC / EWR / EBS / EBG / EBC / EBC / EBB / MAS / MAD / MAC / MAB / COS / CGO / CCL / CBL / PRS / PRG / PRC / PRB \_\_\_\_\_  
Fixture Material: Metal \_\_\_\_\_

#### ELECTRICAL

Lamp Type: LED \_\_\_\_\_  
Input Wattage (W): 21 \_\_\_\_\_  
Total Output Wattage (W): 20 \_\_\_\_\_  
Dimming: Tri-Mode (Non-Dimming and Phase Dimming (120Vac only) and 0-10V Dimming) \_\_\_\_\_  
Driver Included: Yes \_\_\_\_\_  
Driver Location: Integrated \_\_\_\_\_  
Driver Type: Constant Current - Universal \_\_\_\_\_  
Driver Class: Class 2 \_\_\_\_\_  
Input Voltage (V): 120 - 277 \_\_\_\_\_  
Constant Current (MA): 250 \_\_\_\_\_  
Upon Request: 0-10Vdc dimming / Phase dimming @120Vac / 277Vac \_\_\_\_\_

#### LED

Number of LEDs: 2 \_\_\_\_\_  
Color Temperature (°K): 3000 \_\_\_\_\_  
Max. Delivered Lumen (lm): 1100 \_\_\_\_\_  
CRI: >85 CRI \_\_\_\_\_  
Lamp Life (hrs): 50000 \_\_\_\_\_

#### OPTICAL

##### RATINGS AND CERTIFICATIONS

Certified By: Certified for North American Standards \_\_\_\_\_  
IP rating: IP20 \_\_\_\_\_

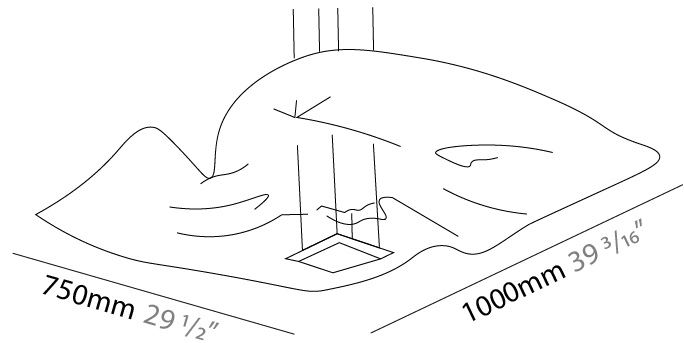

## CRASH SURFACE

D132053-

PROJECT

TYPE

SPECIFIER

QUANTITY

DATE



D

PROJECT	_____
TYPE	_____
SPECIFIER	_____
QUANTITY	_____
DATE	_____

## CRASH SURFACE

**D132056-** \_\_\_\_\_  
base number

- To build a product code in our configurator select the specify button on the base model # product page
- To build a manual product code on this datasheet choose from the options listed below in blue font and add the suffix to the base model #

### GENERAL

Series: Crash  
 Brand: Knikerboker  
 Division: Design  
 Mounting Type: Surface  
 Mounting Location: Ceiling

### PHYSICAL

Shape: Rectangle  
 Length (mm): 1000  
 Length (in): 39 <sup>3</sup>/<sub>8</sub>  
 Width (mm): 1000  
 Width (in): 39 <sup>3</sup>/<sub>8</sub>  
 Height (mm): 250  
 Height (in): 9 <sup>13</sup>/<sub>16</sub>  
 Light Distribution: Indirect  
 Fixture Finish: EWH / EBK / MAN / COF / PRD / SLF / GLF / CLF / BRL / EWS / EWG / EWC / EWR / EBS / EBG / EBC / EBC / EBB / MAS / MAD / MAC / MAB / COS / CGO / CCL / CBL / PRS / PRG / PRC / PRB  
 Fixture Material: Metal

### ELECTRICAL

Lamp Type: LED  
 Input Wattage (W): 21  
 Total Output Wattage (W): 20  
 Dimming: Tri-Mode (Non-Dimming and Phase Dimming (120Vac only) and 0-10V Dimming)  
 Driver Included: Yes  
 Driver Location: Integrated  
 Driver Type: Constant Current - Universal  
 Driver Class: Class 2  
 Input Voltage (V): 120 - 277  
 Constant Current (MA): 250  
 Upon Request: 0-10Vdc dimming / Phase dimming @120Vac / 277Vac

### LED

Number of LEDs: 2  
 Color Temperature (°K): 3000  
 Max. Delivered Lumen (lm): 1100  
 CRI: >85 CRI  
 Lamp Life (hrs): 50000

### OPTICAL

#### RATINGS AND CERTIFICATIONS

Certified By: Certified for North American Standards  
 IP rating: IP20

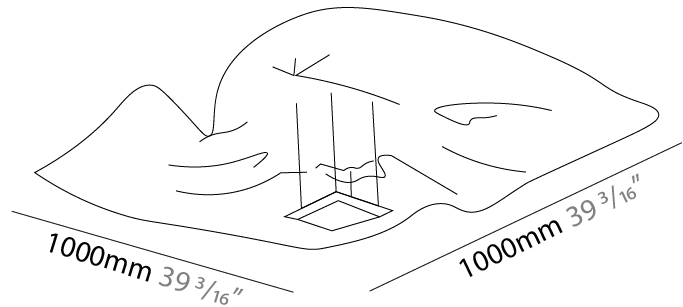

PROJECT
TYPE
SPECIFIER
QUANTITY
DATE

## CRASH SURFACE

**D132109-** \_\_\_\_\_  
base number

- To build a product code in our configurator select the specify button on the base model # product page
- To build a manual product code on this datasheet choose from the options listed below in blue font and add the suffix to the base model #

### GENERAL

Series: Crash  
 Brand: Knikerboker  
 Division: Design  
 Mounting Type: Surface  
 Mounting Location: Ceiling  
 Subcategory: Pendant

### PHYSICAL

Shape: Abstract  
 Length (mm): 200  
 Length (in): 7 7/8  
 Width (mm): 200  
 Width (in): 7 7/8  
 Height (mm): 250  
 Height (in): 9 13/16  
 Light Distribution: Indirect  
 Fixture Finish: EWH / EBK / MAN / COF / PRD / SLF / GLF / CLF / BRL / EWS / EWG / EWC / EWR / EBS / EBG / EBC / EBC / EBB / MAS / MAD / MAC / MAB / COS / CGO / CCL / CBL / PRS / PRG / PRC / PRB  
 Fixture Material: Metal

### ELECTRICAL

Lamp Type: LED  
 Input Wattage (W): 10.5  
 Total Output Wattage (W): 10  
 Dimming: Tri-Mode (Non-Dimming and Phase Dimming (120Vac only) and 0-10V Dimming)  
 Driver Included: Yes  
 Driver Location: Integrated  
 Driver Type: Constant Current - Universal  
 Driver Class: Class 2  
 Input Voltage (V): 120 - 277  
 Constant Current (MA): 250  
 Upon Request: 0-10Vdc Dimming / Phase dimming @120Vac only / Non-dimming 120/277Vac

### LED

Number of LEDs: 1  
 Color Temperature (°K): 3000  
 Max. Delivered Lumen (lm): 1100  
 CRI: >85 CRI  
 Lamp Life (hrs): 50000

### OPTICAL

### RATINGS AND CERTIFICATIONS

Certified By: Certified for North American Standards  
 IP rating: IP20

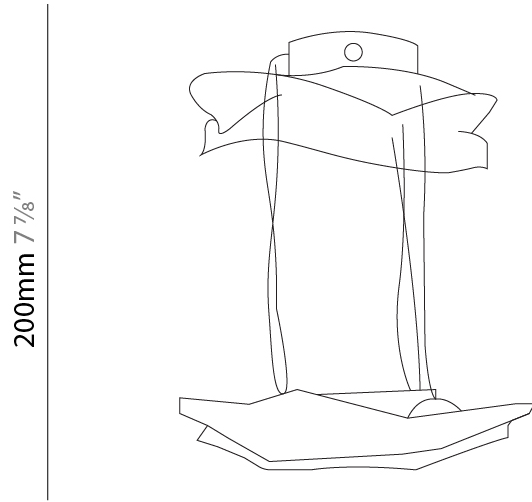
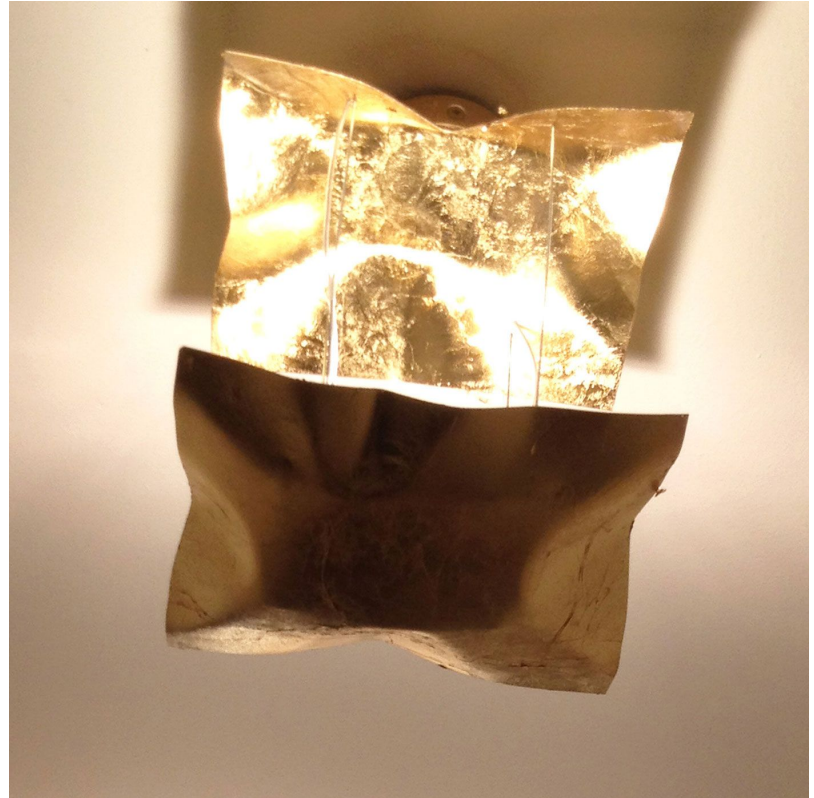

200mm 7 7/8"

200mm 7 7/8"



## CRASH SURFACE

D132109-

PROJECT

TYPE

SPECIFIER

QUANTITY

DATE

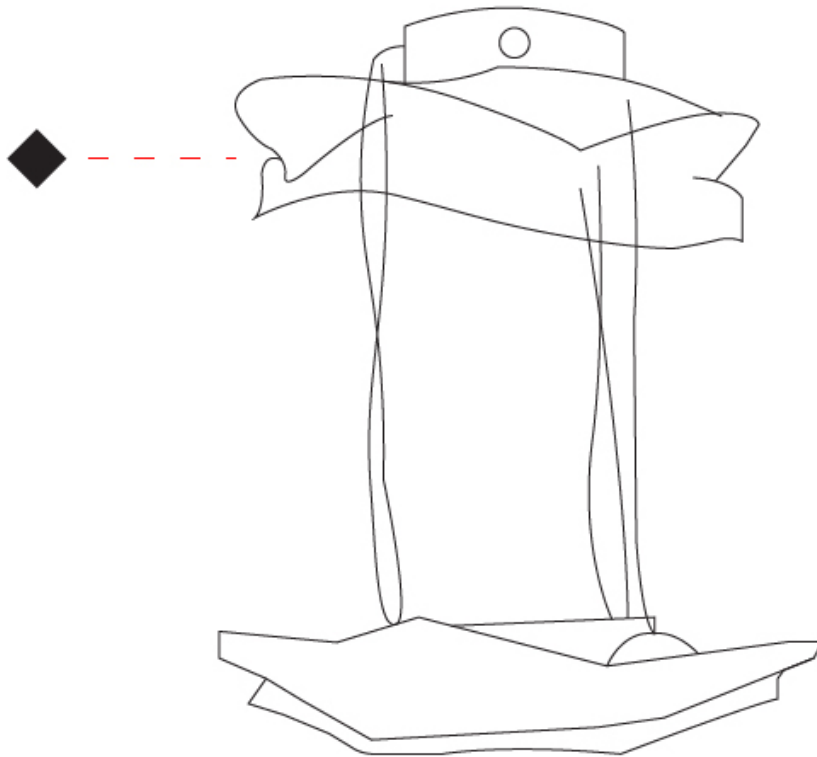

D

## CRASH

### COLOR FINISH CHART

#### Fixture Finish

Embossed White - EWH



Embossed Black - EBK

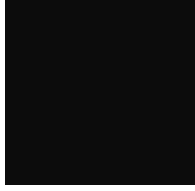

Metallic Anthracite - MAN

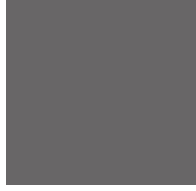

Coffee - COF

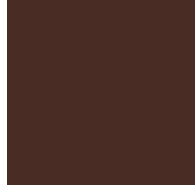

Purple Red - PRD



Silver Leaf - SLF

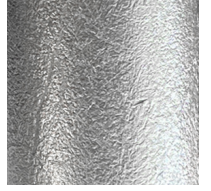

Gold Leaf - GLF



Copper Leaf - CLF

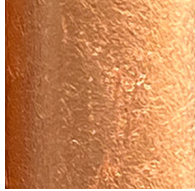

Bronze Leaf - BRL



Metallic Anthracite / Silver Leaf - MAS

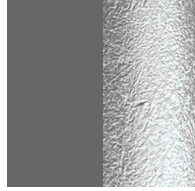

Metallic Anthracite / Gold Leaf - MAD

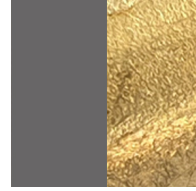

Metallic Anthracite / Copper Leaf - MAC

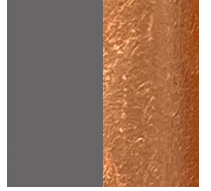

Metallic Anthracite / Bronze Leaf - MAB



Coffee / Silver Leaf - COS

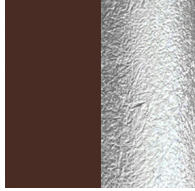

Coffee / Gold Leaf - CGO

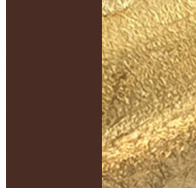

Coffee / Copper Leaf - CCL



Coffee / Bronze Leaf - CBL



Purple Red / Silver Leaf - PRS

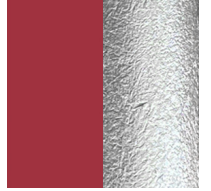

Purple Red / Gold Leaf - PRG



Purple Red / Copper Leaf - PRC

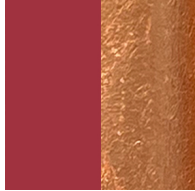

Purple Red / Bronze Leaf - PRB



**Digital:** Not all screens are calibrated the same, and therefore, colors will appear differently between screens.

**Physical:** When texture is involved, there will be variations in color, character and tone within a product series and between product families.



### LEGEND

 floor-mounted	 pivotable	 special LED (upon request) RGB, RGBW, tunable, gold+, meat+, art+, fashion+
 wall and ceiling: recessed and surface mounted	 rotating	 warm dim / natural dimming LED
 ceiling-mounted and wall-mounted	 illuminate tilted	 rechargeable battery powered
 wall-mounted	 color of suspension cable	 fixture with natural vivid LED (upon request)
 omni-directional light distribution	 length of suspension cable	 color rendering index
 direct light distribution	 reflector degree selection	 color temperature
 direct/indirect light distribution	 super spot	 lumen (luminous flux)
 indirect light distribution	 lens	 efficacy (lumens per watt)
 asymmetric light distribution	 lens pack	 Unified Glare Rating (UGR) range from 5-40
 aura light distribution	 shine ring	 marine grade (AISI 316 stainless steel)
 round wall or ceiling cut-out	 integrated shine ring with diffuser	 walk on
 square wall or ceiling cut-out	 free individual colors 01-29	 drive on
 the supplied jig specifies the cutout dimensions	 individual colors: 00 (free of charge), 01-25 (extra charge)	 Dark Sky Compliance
 minimum distance (meters) lamp - object	 luminaire part to be colored (F1)	 Americans with Disabilities Act (less than 4" off the wall located between 27"-84" from floor)
 recessed depth	 luminaire part to be colored (F2)	 lamp protected against explosion
 ceiling thickness in mm	 luminaire part to be colored (F3)	 blown glass using traditional methods by master glass blower
 ceiling thickness selection	 luminaire part to be colored (F4)	 acoustic material
 dimmable DP (phase), DV (0-10V), DD (dali), DS (step-dim)	 luminaire part to be colored (F5)	 protection class I, protection insulation
 included or excluded LED driver/transformer/control gear	 color of 3-circuit adaptor	 protection class II, protection insulation
 separately switchable	 indirect diffuser	 ETL Certified to UL and CSA Standards
 sensor	 direct diffuser	 UL Certified to UL and CSA Standards
 remote control	 ball-proof (upon request)	 CSA Certified to UL and CSA Standards
 available upon request	 accessory	 Certified for North American Standards

### IP RATING

 IP20	protected against ingress of solid bodies greater than 12.5mm (finger)
 IP33	protected against ingress of solid bodies greater than 2.5mm protected against sprays of water up to 60 degrees from the vertical (rain)
 IP40	protected against ingress of solid bodies greater than 1mm (wire) no protection against the ingress of moisture
 IP43	protected against ingress of solid bodies greater than 1mm (wire) protected against sprays of water up to 60 degrees from the vertical (rain)
 IP44	protected against ingress of solid bodies greater than 1mm (wire) protected against water splashed from all directions
 IP54	protected against limited ingress of dust (wet rooms/covered outdoor areas) protected against water splashed from all directions
 IP65	protected against ingress of dust protected against jets of water
 IP66	protected against ingress of dust protected against powerful jets of water or heavy seas
 IP67	protected against ingress of dust protected against immersion of water between 15cm - 1m for 30 minutes
 IP68	protected against ingress of dust protected against immersion of water under pressure for long periods

### IK RATING

 IK01	protected against 0.14 joules impact (equivalent to 0.25kg mass dropped from 56mm above the surface)
 IK02	protected against 0.2 joules impact (equivalent to 0.25kg mass dropped from 80mm above the surface)
 IK03	protected against 0.35 joules impact (equivalent to 0.25kg mass dropped from 140mm above the surface)
 IK04	protected against 0.5 joules impact (equivalent to 0.25kg mass dropped from 200mm above the surface)
 IK05	protected against 0.7 joules impact (equivalent to 0.25kg mass dropped from 280mm above the surface)
 IK06	protected against 1 joules impact (equivalent to 0.25kg mass dropped from 400mm above the surface)
 IK07	protected against 2 joules impact (equivalent to 0.5kg mass dropped from 400mm above the surface)
 IK08	protected against 5 joules impact (equivalent to 1.7kg mass dropped from 300mm above the surface)
 IK09	protected against 10 joules impact (equivalent to 5.0kg mass dropped from 200mm above the surface)
 IK10	protected against 20 joules impact (equivalent to 5.0kg mass dropped from 400mm above the surface)