

## CURLED SUSPENSION

### D101421-

base number    LED Dimming    Color Temperature    Finish Options

- To build a product code in our configurator select the specify button on the base model # product page
- To build a manual product code on this datasheet choose from the options listed below in blue font and add the suffix to the base model #

#### GENERAL

Series: Curled  
 Partner: Quasar  
 Division: Design  
 Installation: Suspension  
 Product Type: Chandelier  
 Mounting Location: Ceiling

#### PHYSICAL

Shape: Abstract  
 Length (mm): 1250  
 Length (in): 49 3/16  
 Width (mm): 400  
 Width (in): 15 3/4  
 Height (mm): 400  
 Height (in): 15 3/4  
 Max. Overall Height (mm): 2400  
 Max. Overall Height (in): 94 1/2  
 Weight (kg): 4.5  
 Weight (lbs): 9.92  
 Fixture Finish: [NIC / BRA / BBR](#)  
 Fixture Material: Metal  
 Cable Details: 2000mm Cable  
 Upon Request: Custom Sizes

#### ELECTRICAL

Number of Lamps: 50  
 Lamp Type: LED Retrofit  
 Bulb Included: Bulb Included  
 Total Output Wattage (W): 16.5  
 Max. Wattage Per Lamp (W): 0.33  
 Lamp Base: E10  
 Dimming: [Phase Dimming \(120Vac Only\)](#)  
 Driver Included: Yes  
 Driver Location: Integrated  
 Driver Type: Constant Voltage - Universal  
 Driver Class: Class 2  
 Input Voltage (V): 120 - 277  
 Output Voltage (V): 12  
 Lamp Voltage (V): 12  
 Upon Request: Phase dimming @120Vac only / Non-dimming @277Vac

#### LED

Color Temperature (°K): [2600 / 3000 / 3500](#)  
 Max. Delivered Lumen (lm): 1150 (2600K)  
 CRI: >90 CRI  
 Lamp Life (hrs): 20000

#### OPTICAL

#### RATINGS AND CERTIFICATIONS

Certified By: Certified for North American Standards  
 IP rating: IP20

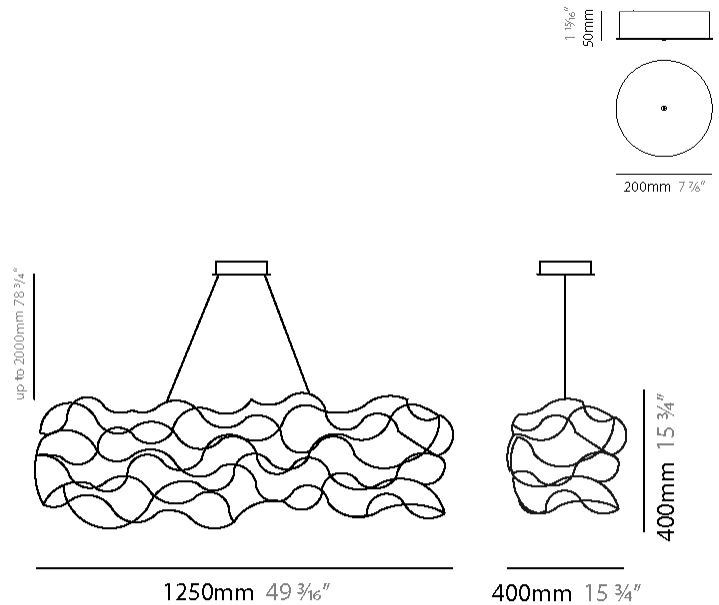

## CURLED SUSPENSION

D101421-

PROJECT	_____
TYPE	_____
SPECIFIER	_____
QUANTITY	_____
DATE	_____

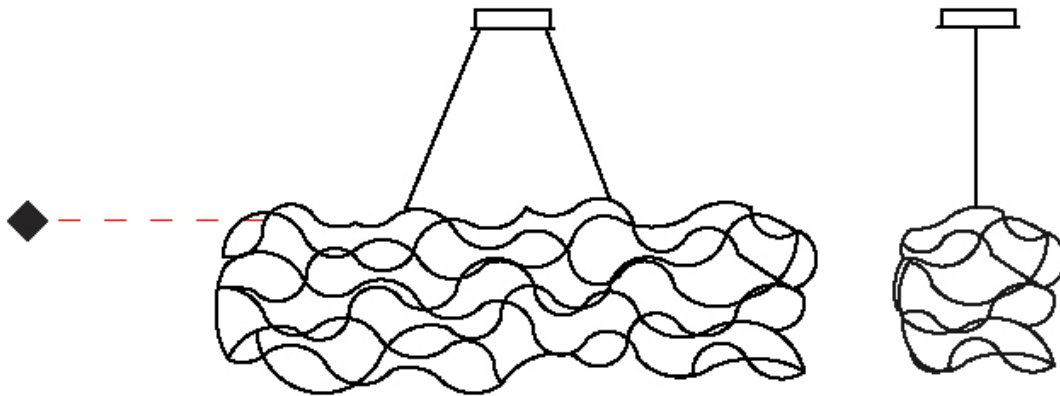

D

## CURLED SUSPENSION

### D101425-

base number    LED Dimming    Color Temperature    Finish Options

- To build a product code in our configurator select the specify button on the base model # product page
- To build a manual product code on this datasheet choose from the options listed below in blue font and add the suffix to the base model #

#### GENERAL

Series: Curled  
 Partner: Quasar  
 Division: Design  
 Installation: Suspension  
 Product Type: Chandelier  
 Mounting Location: Ceiling

#### PHYSICAL

Shape: Abstract  
 Length (mm): 1800  
 Length (in): 70 <sup>7</sup>/<sub>8</sub>  
 Width (mm): 400  
 Width (in): 15 <sup>3</sup>/<sub>4</sub>  
 Height (mm): 400  
 Height (in): 15 <sup>3</sup>/<sub>4</sub>  
 Max. Overall Height (mm): 2400  
 Max. Overall Height (in): 94 <sup>1</sup>/<sub>2</sub>  
 Weight (kg): 5  
 Weight (lbs): 11.02  
 Fixture Finish: [NIC / BRA / BBR](#)  
 Fixture Material: Metal  
 Cable Details: 2000mm Cable  
 Upon Request: Custom Sizes

#### ELECTRICAL

Number of Lamps: 70  
 Lamp Type: LED Retrofit  
 Bulb Included: Bulb Included  
 Total Output Wattage (W): 23.1  
 Max. Wattage Per Lamp (W): 0.33  
 Lamp Base: E10  
[Dimming: Phase Dimming \(120Vac Only\)](#)  
 Driver Included: Yes  
 Driver Location: Integrated  
 Driver Type: Constant Voltage - Universal  
 Driver Class: Class 2  
 Input Voltage (V): 120 - 277  
 Output Voltage (V): 12  
 Lamp Voltage (V): 12  
 Upon Request: Phase dimming @120Vac only / Non-dimming @277Vac

#### LED

[Color Temperature \(°K\): 2600 / 3000 / 3500](#)  
 Max. Delivered Lumen (lm): 1610 (2600K)  
 CRI: >90 CRI  
 Lamp Life (hrs): 20000

#### OPTICAL

#### RATINGS AND CERTIFICATIONS

Certified By: Certified for North American Standards  
 IP rating: IP20

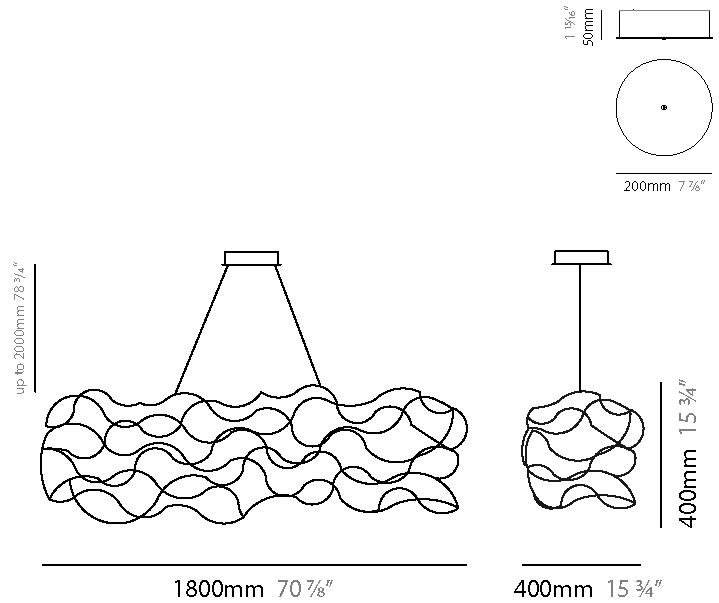

## CURLED SUSPENSION

D101425-

PROJECT \_\_\_\_\_

TYPE \_\_\_\_\_

SPECIFIER \_\_\_\_\_

QUANTITY \_\_\_\_\_

DATE \_\_\_\_\_

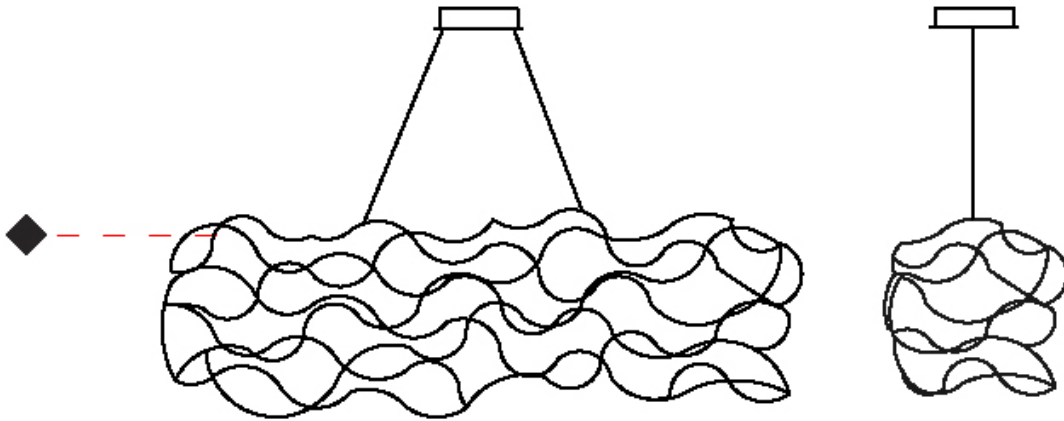

D

PROJECT	_____
TYPE	_____
SPECIFIER	_____
QUANTITY	_____
DATE	_____

## CURLED SUSPENSION

### D101429-

base number	LED Dimming	Color Temperature	Finish Options
-------------	-------------	-------------------	----------------

- To build a product code in our configurator select the specify button on the base model # product page
- To build a manual product code on this datasheet choose from the options listed below in blue font and add the suffix to the base model #

#### GENERAL

Series: Curled
Partner: Quasar
Division: Design
Installation: Suspension
Product Type: Chandelier
Mounting Location: Ceiling

#### PHYSICAL

Shape: Abstract
Length (mm): 2000
Length (in): 78 ¾"
Width (mm): 400
Width (in): 15 ¾"
Height (mm): 400
Height (in): 15 ¾"
Max. Overall Height (mm): 2400
Max. Overall Height (in): 92 ½"
Weight (kg): 5
Weight (lbs): 11.02
Fixture Finish: <a href="#">NIC / BRA / BBR</a>
Fixture Material: Metal
Cable Details: 2000mm Cable
Upon Request: Custom Sizes

#### ELECTRICAL

Number of Lamps: 70
Lamp Type: LED Retrofit
Bulb Included: Bulb Included
Total Output Wattage (W): 23.1
Max. Wattage Per Lamp (W): 0.33
Lamp Base: E10
<a href="#">Dimming: Phase Dimming (120Vac Only)</a>
Driver Included: Yes
Driver Location: Integrated
Driver Type: Constant Voltage - Universal
Driver Class: Class 2
Input Voltage (V): 120 - 277
Output Voltage (V): 12
Lamp Voltage (V): 12
Upon Request: Phase dimming @120Vac only / Non-dimming @277Vac

#### LED

<a href="#">Color Temperature (°K): 2600 / 3000 / 3500</a>
Max. Delivered Lumen (lm): 1610 (2600K)
CRI: >90 CRI
Lamp Life (hrs): 20000

#### OPTICAL

#### RATINGS AND CERTIFICATIONS

Certified By: Certified for North American Standards
IP rating: IP20

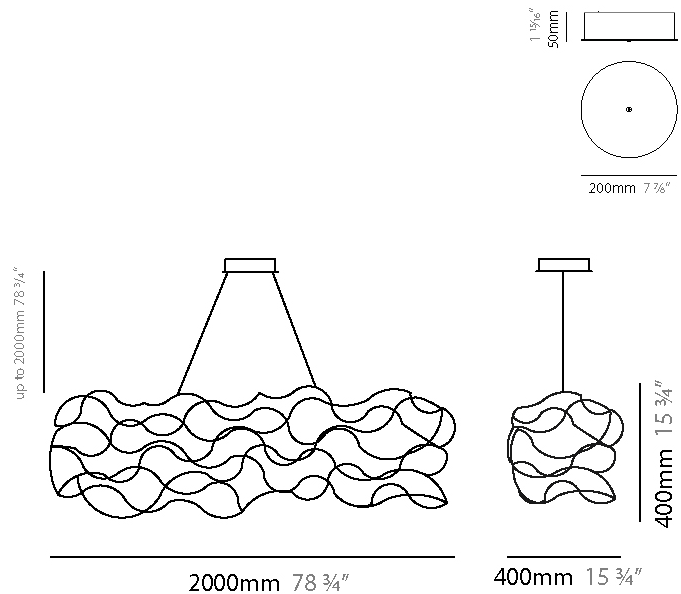

## CURLED SUSPENSION

D101429-

PROJECT	_____
TYPE	_____
SPECIFIER	_____
QUANTITY	_____
DATE	_____

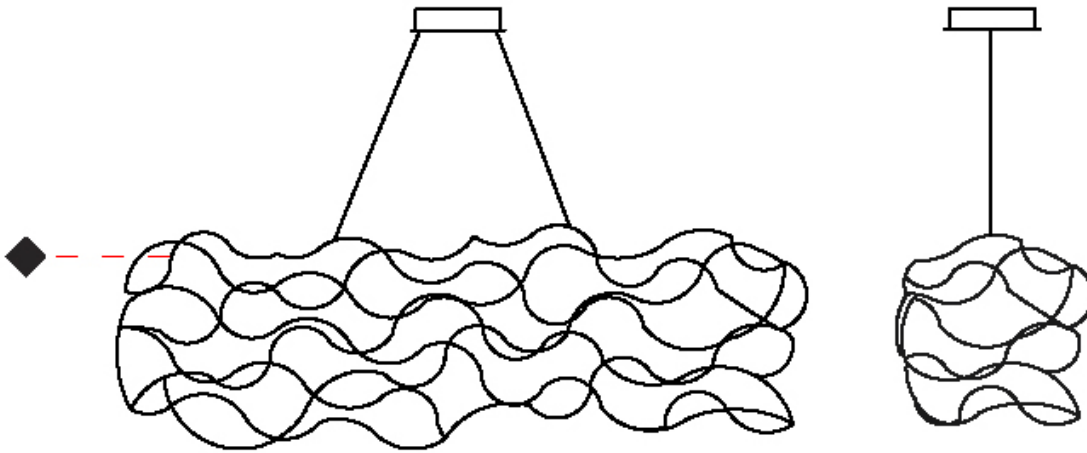

D

PROJECT \_\_\_\_\_  
 TYPE \_\_\_\_\_  
 SPECIFIER \_\_\_\_\_  
 QUANTITY \_\_\_\_\_  
 DATE \_\_\_\_\_

## CURLED SUSPENSION

### D101433-

base number    LED    Color    Finish  
 Dimming    Temperature    Options

- To build a product code in our configurator select the specify button on the base model # product page
- To build a manual product code on this datasheet choose from the options listed below in blue font and add the suffix to the base model #

#### GENERAL

Series: Curled  
 Partner: Quasar  
 Division: Design  
 Installation: Suspension  
 Product Type: Chandelier  
 Mounting Location: Ceiling

#### PHYSICAL

Shape: Abstract  
 Diameter (mm): 700  
 Diameter (in): 27 <sup>9</sup>/<sub>16</sub>"  
 Height (mm): 300  
 Height (in): 11 <sup>13</sup>/<sub>16</sub>"  
 Max. Overall Height (mm): 2300  
 Max. Overall Height (in): 90 <sup>9</sup>/<sub>16</sub>"  
 Weight (kg): 2  
 Weight (lbs): 4.41  
 Fixture Finish: [NIC / BRA / BBR](#)  
 Fixture Material: Metal  
 Cable Details: 2000mm Cable  
 Upon Request: Custom Sizes

#### ELECTRICAL

Number of Lamps: 50  
 Lamp Type: LED Retrofit  
 Bulb Included: Bulb Included  
 Total Output Wattage (W): 16.5  
 Max. Wattage Per Lamp (W): 0.33  
 Lamp Base: E10  
 Dimming: [Phase Dimming \(120Vac Only\)](#)  
 Driver Included: Yes  
 Driver Location: Integrated  
 Driver Type: Constant Voltage - Universal  
 Driver Class: Class 2  
 Input Voltage (V): 120 - 277  
 Output Voltage (V): 12  
 Lamp Voltage (V): 12  
 Upon Request: Phase dimming @120Vac only / Non-dimming @277Vac

#### LED

[Color Temperature \(°K\): 2600 / 3000 / 3500](#)  
 Max. Delivered Lumen (lm): 1150 (2600K)  
 CRI: >90 CRI  
 Lamp Life (hrs): 20000

#### OPTICAL

#### RATINGS AND CERTIFICATIONS

Certified By: Certified for North American Standards  
 IP rating: IP20

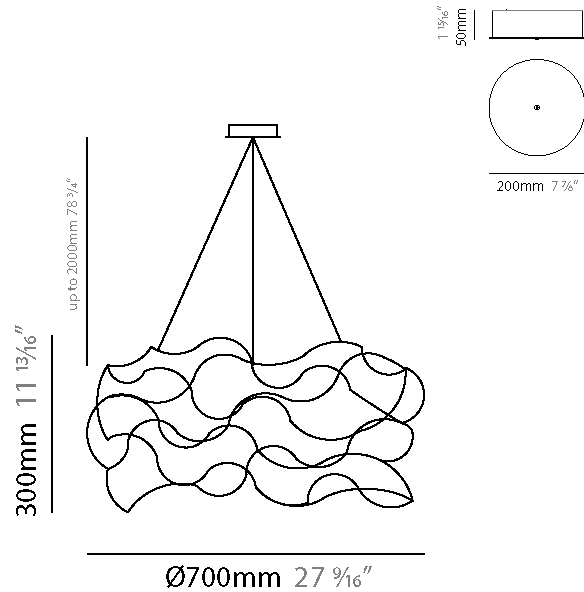

## CURLED SUSPENSION

D101433-

PROJECT \_\_\_\_\_

TYPE \_\_\_\_\_

SPECIFIER \_\_\_\_\_

QUANTITY \_\_\_\_\_

DATE \_\_\_\_\_

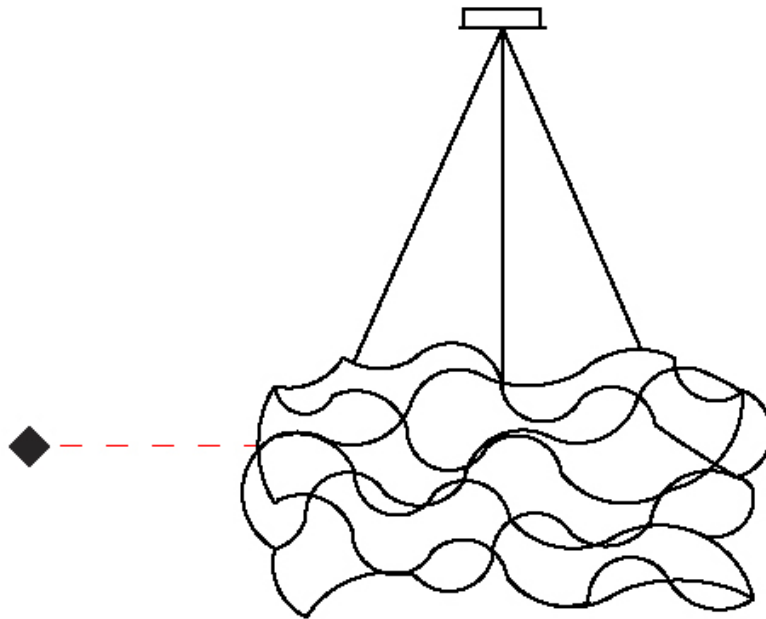

D

## CURLED SUSPENSION

### D101437-

base number    LED Dimming    Color Temperature    Finish Options

- To build a product code in our configurator select the specify button on the base model # product page
- To build a manual product code on this datasheet choose from the options listed below in blue font and add the suffix to the base model #

#### GENERAL

Series: Curled  
 Partner: Quasar  
 Division: Design  
 Installation: Suspension  
 Product Type: Chandelier  
 Mounting Location: Ceiling

#### PHYSICAL

Shape: Abstract  
 Diameter (mm): 1300  
 Diameter (in): 51 <sup>3</sup>/<sub>16</sub>"  
 Height (mm): 400  
 Height (in): 15 <sup>3</sup>/<sub>4</sub>"  
 Max. Overall Height (mm): 2400  
 Max. Overall Height (in): 94 <sup>1</sup>/<sub>2</sub>"  
 Weight (kg): 6.5  
 Weight (lbs): 14.33  
 Fixture Finish: [NIC / BRA / BBR](#)  
 Fixture Material: Metal  
 Cable Details: 2000mm Cable  
 Upon Request: Custom Sizes

#### ELECTRICAL

Number of Lamps: 130  
 Lamp Type: LED Retrofit  
 Bulb Included: Bulb Included  
 Total Output Wattage (W): 42.9  
 Max. Wattage Per Lamp (W): 0.33  
 Lamp Base: E10  
 Dimming: [Phase Dimming \(120Vac Only\)](#)  
 Driver Included: Yes  
 Driver Location: Integrated  
 Driver Type: Constant Voltage - Universal  
 Driver Class: Class 2  
 Input Voltage (V): 120 - 277  
 Output Voltage (V): 12  
 Lamp Voltage (V): 12  
 Upon Request: Phase dimming @120Vac only / Non-dimming @277Vac

#### LED

[Color Temperature \(°K\): 2600 / 3000 / 3500](#)  
 Max. Delivered Lumen (lm): 2990 (2600K)  
 CRI: >90 CRI  
 Lamp Life (hrs): 20000

#### OPTICAL

#### RATINGS AND CERTIFICATIONS

Certified By: Certified for North American Standards  
 IP rating: IP20

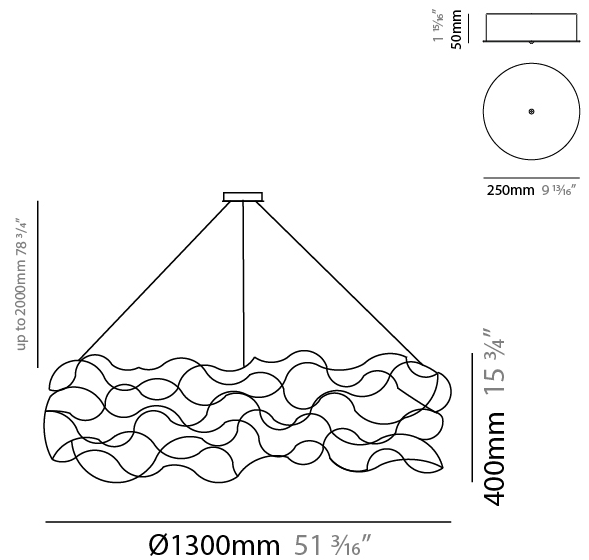

## CURLED SUSPENSION

D101437-

PROJECT

TYPE

SPECIFIER

QUANTITY

DATE

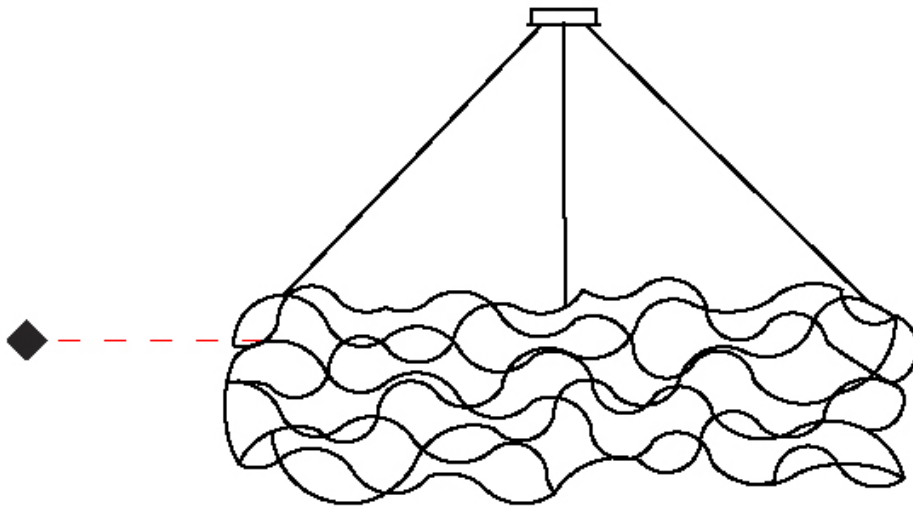

PROJECT	_____
TYPE	_____
SPECIFIER	_____
QUANTITY	_____
DATE	_____

## CURLED SUSPENSION

### D101441-

base number	LED Dimming	Color Temperature	Finish Options
-------------	----------------	----------------------	-------------------

- To build a product code in our configurator select the specify button on the base model # product page
- To build a manual product code on this datasheet choose from the options listed below in blue font and add the suffix to the base model #

#### GENERAL

Series: Curled
Partner: Quasar
Division: Design
Installation: Suspension
Product Type: Chandelier
Mounting Location: Ceiling

#### PHYSICAL

Shape: Abstract
Diameter (mm): 2000
Diameter (in): 78 3/4
Height (mm): 400
Height (in): 15 3/4
Max. Overall Height (mm): 2400
Max. Overall Height (in): 94 1/2
Weight (kg): 6
Weight (lbs): 13.23
Fixture Finish: <a href="#">NIC / BRA / BBR</a>
Fixture Material: Metal
Cable Details: 2000mm Cable
Upon Request: Custom Sizes

#### ELECTRICAL

Number of Lamps: 200
Lamp Type: LED Retrofit
Bulb Included: Bulb Included
Total Output Wattage (W): 66
Max. Wattage Per Lamp (W): 0.33
Lamp Base: E10
Dimming: <a href="#">Phase Dimming (120Vac Only)</a>
Driver Included: Yes
Driver Location: Integrated
Driver Type: Constant Voltage - Universal
Driver Class: Class 2
Input Voltage (V): 120 - 277
Output Voltage (V): 12
Lamp Voltage (V): 12
Upon Request: Phase dimming @120Vac only / Non-dimming @277Vac

#### LED

Color Temperature (°K): <a href="#">2600 / 3000 / 3500</a>
Max. Delivered Lumen (lm): 4600 (2600K)
CRI: >90 CRI
Lamp Life (hrs): 20000

#### OPTICAL

#### RATINGS AND CERTIFICATIONS

Certified By: Certified for North American Standards
IP rating: IP20

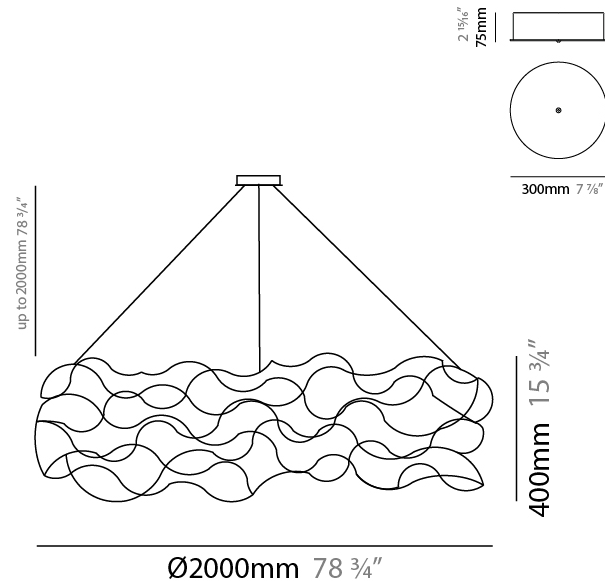

## CURLED SUSPENSION

D101441-

PROJECT

TYPE

SPECIFIER

QUANTITY

DATE

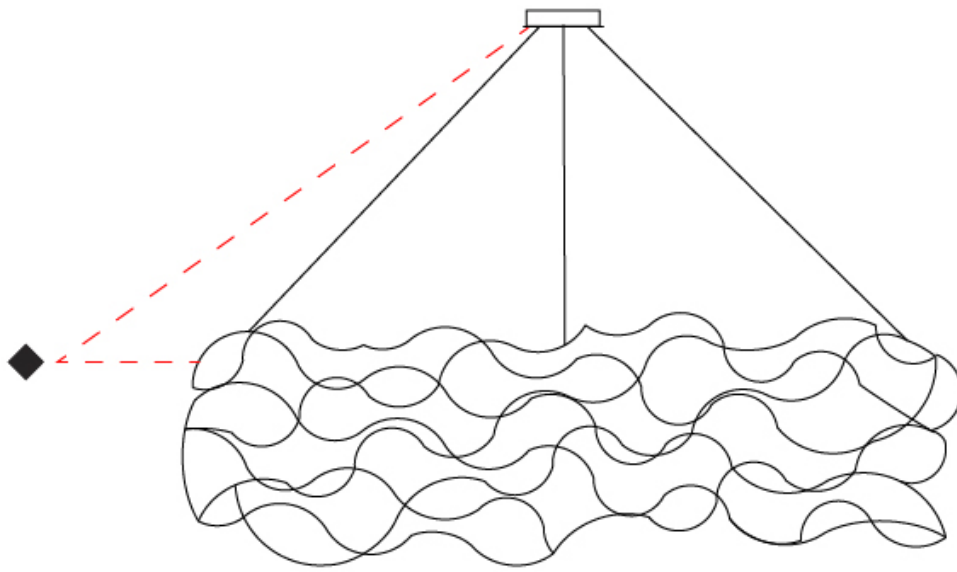

PROJECT	_____
TYPE	_____
SPECIFIER	_____
QUANTITY	_____
DATE	_____

## CURLED SURFACE

### D103081-

base number	LED	Color	Finish
	Dimming	Temperature	Options

- To build a product code in our configurator select the specify button on the base model # product page
- To build a manual product code on this datasheet choose from the options listed below in blue font and add the suffix to the base model #

#### GENERAL

Series: Curled
Partner: Quasar
Division: Design
Installation: Surface
Product Type: Ceiling Surface
Mounting Location: Ceiling

#### PHYSICAL

Shape: Abstract
Diameter (mm): 700
Diameter (in): 27 <sup>9</sup> / <sub>16</sub>
Height (mm): 700
Height (in): 27 <sup>9</sup> / <sub>16</sub>
Extension (mm): 300
Extension (in): 11 <sup>13</sup> / <sub>16</sub>
Weight (kg): 3.5
Weight (lbs): 7.72
Fixture Finish: <a href="#">NIC / BRA / BBR</a>
Fixture Material: Metal
Upon Request: Custom Sizes

#### ELECTRICAL

Number of Lamps: 50
Lamp Type: LED Retrofit
Bulb Included: Bulb Included
Total Output Wattage (W): 16.5
Max. Wattage Per Lamp (W): 0.33
Lamp Base: E10
<a href="#">Dimming: 0-10V Dimming / Phase Dimming (120Vac Only)</a>
Driver Included: Yes
Driver Location: Integrated
Driver Type: Constant Voltage - Universal
Driver Class: Class 2
Input Voltage (V): 120 - 277
Output Voltage (V): 12
Lamp Voltage (V): 12
Upon Request: (Not Included - see components) Integral: 0-10Vdc dimming / (Included) Integral: Phase dimming @120Vac only / Non-dimming @277Vac

#### LED

<a href="#">Color Temperature (°K): 2600 / 3000 / 3500</a>
Max. Delivered Lumen (lm): 1150 (2600K)
CRI: >90 CRI
Lamp Life (hrs): 20000

#### OPTICAL

#### RATINGS AND CERTIFICATIONS

Certified By: Certified for North American Standards
IP rating: IP20

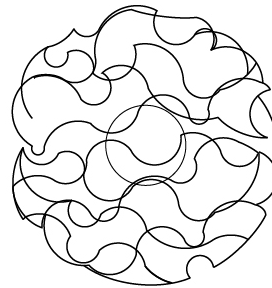
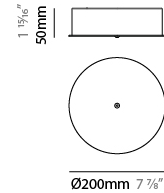
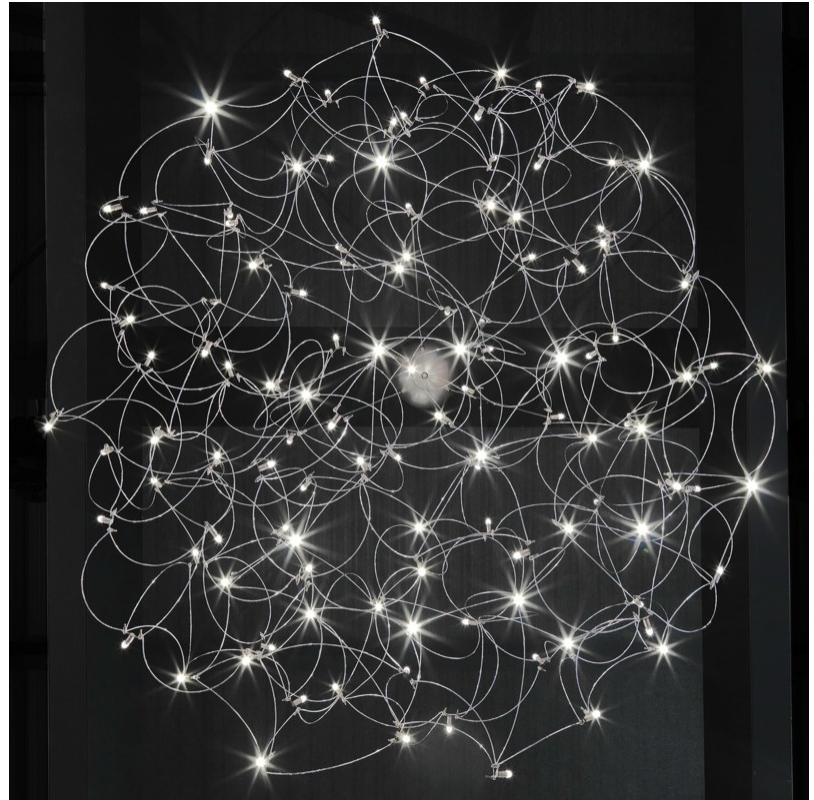

Ø700mm 27 <sup>9</sup>/<sub>16</sub>"

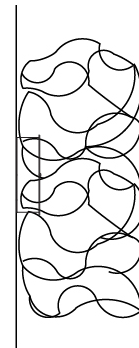

300mm 11 <sup>13</sup>/<sub>16</sub>"



## CURLED SURFACE

D103081-

PROJECT \_\_\_\_\_

TYPE \_\_\_\_\_

SPECIFIER \_\_\_\_\_

QUANTITY \_\_\_\_\_

DATE \_\_\_\_\_

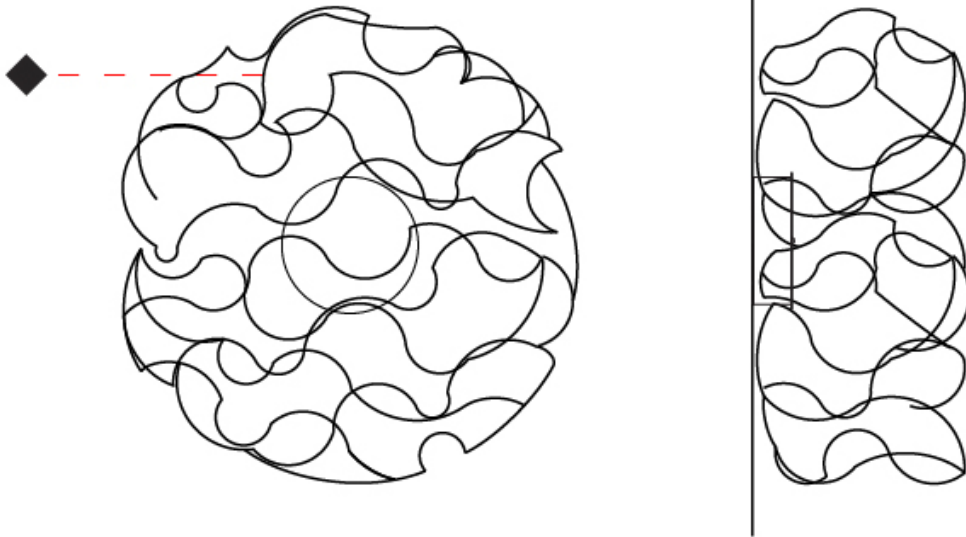

D

## CURLED COLOR FINISH CHART

PROJECT	_____
TYPE	_____
SPECIFIER	_____
QUANTITY	_____
DATE	_____

### Fixture Finish

Nickel - NIC



Brass - BRA



Black Brass - BBR

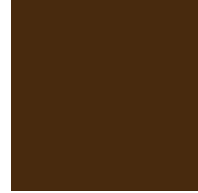

**Digital:** Not all screens are calibrated the same, and therefore, colors will appear differently between screens.

**Physical:** When texture is involved, there will be variations in color, character and tone within a product series and between product families.

Brass, nickel and copper are natural minerals and can potentially change color and show marks over time. We cannot guarantee the color appearance as the material transforms.



### LEGEND

	floor-mounted		pivotal		special LED (upon request) RGB, RGBW, tunable, gold+, meat+, art+, fashion+
	wall and ceiling: recessed and surface mounted		rotating		warm dim / natural dimming LED
	ceiling-mounted and wall-mounted		illuminate tilted		rechargeable battery powered
	wall-mounted		color of suspension cable		fixture with natural vivid LED (upon request)
	omni-directional light distribution		length of suspension cable		color rendering index
	direct light distribution		reflector degree selection		color temperature
	direct/indirect light distribution		super spot		lumen (luminous flux)
	indirect light distribution		lens		efficacy (lumens per watt)
	asymmetric light distribution		lens pack		Unified Glare Rating (UGR) range from 5-40
	aura light distribution		shine ring		marine grade (AISI 316 stainless steel)
	round wall or ceiling cut-out		integrated shine ring with diffuser		walk on
	square wall or ceiling cut-out		free individual colors 01-29		drive on
	the supplied jig specifies the cutout dimensions		individual colors: 00 (free of charge), 01-25 (extra charge)		Dark Sky Compliance
	minimum distance (meters) lamp - object		luminaire part to be colored (F1)		Americans with Disabilities Act (less than 4" off the wall located between 27"-84" from floor)
	recessed depth		luminaire part to be colored (F2)		lamp protected against explosion
	ceiling thickness in mm		luminaire part to be colored (F3)		blown glass using traditional methods by master glass blower
	ceiling thickness selection		luminaire part to be colored (F4)		acoustic material
	dimnable DP (phase), DV (0-10V), DD (dali), DS (step-dim)		luminaire part to be colored (F5)		protection class I, protection insulation
	included or excluded LED driver/transformer/control gear		color of 3-circuit adaptor		protection class II, protection insulation
	separately switchable		indirect diffuser		ETL Certified to UL and CSA Standards
	sensor		direct diffuser		UL Certified to UL and CSA Standards
	remote control		ball-proof (upon request)		CSA Certified to UL and CSA Standards
	available upon request		accessory		Certified for North American Standards

### IP RATING

	protected against ingress of solid bodies greater than 12.5mm (finger)
	protected against ingress of solid bodies greater than 2.5mm protected against sprays of water up to 60 degrees from the vertical (rain)
	protected against ingress of solid bodies greater than 1mm (wire) no protection against the ingress of moisture
	protected against ingress of solid bodies greater than 1mm (wire) protected against sprays of water up to 60 degrees from the vertical (rain)
	protected against ingress of solid bodies greater than 1mm (wire) protected against water splashed from all directions
	protected against limited ingress of dust (wet rooms/covered outdoor areas) protected against water splashed from all directions
	protected against ingress of dust protected against jets of water
	protected against ingress of dust protected against powerful jets of water or heavy seas
	protected against ingress of dust protected against immersion of water between 15cm - 1m for 30 minutes
	protected against ingress of dust protected against immersion of water under pressure for long periods

### IK RATING

	protected against 0.14 joules impact (equivalent to 0.25kg mass dropped from 56mm above the surface)
	protected against 0.2 joules impact (equivalent to 0.25kg mass dropped from 80mm above the surface)
	protected against 0.35 joules impact (equivalent to 0.25kg mass dropped from 140mm above the surface)
	protected against 0.5 joules impact (equivalent to 0.25kg mass dropped from 200mm above the surface)
	protected against 0.7 joules impact (equivalent to 0.25kg mass dropped from 280mm above the surface)
	protected against 1 joules impact (equivalent to 0.25kg mass dropped from 400mm above the surface)
	protected against 2 joules impact (equivalent to 0.5kg mass dropped from 400mm above the surface)
	protected against 5 joules impact (equivalent to 1.7kg mass dropped from 300mm above the surface)
	protected against 10 joules impact (equivalent to 5.0kg mass dropped from 200mm above the surface)
	protected against 20 joules impact (equivalent to 5.0kg mass dropped from 400mm above the surface)