

| | |
|-----------|--|
| PROJECT | |
| TYPE | |
| SPECIFIER | |
| QUANTITY | |
| DATE | |

DELIGHT STRING RECESSED

A35696-

| | | | |
|-------------|-------------|-----------|------------|
| base number | Color | Finishes | Finishes |
| | Temperature | (Diamond) | (Triangle) |

- To build a product code in our configurator select the specify button on the base model # product page
- To build a manual product code on this datasheet choose from the options listed below in blue font and add the suffix to the base model #

GENERAL

| |
|---------------------------|
| Series: Delight |
| Subseries: Delight String |
| Brand: Prolicht |
| Division: Architectural |
| Mounting Type: Recessed |
| Mounting Location: Wall |
| Subcategory: Step Light |

PHYSICAL

| |
|---|
| Shape: Rectangle |
| Width (mm): 40 |
| Width (in): 1 9/16 |
| Height (mm): 150 |
| Depth (mm): 26 |
| Height (in): 5 7/8 |
| Depth (in): 1 |
| Ceiling Thickness (mm): 10 / 12 / 15 |
| Ceiling Thickness (in): 3/8 or 1/2 or 9/16 |
| Min. Recessing Depth (mm): 30 |
| Min. Recessing Depth (in): 1 3/16 |
| Light Distribution: Asymmetric |
| Weight (kg): .21 |
| Weight (lbs): .46 |
| Installation Requirement: 140mm / 5 1/2" x 34mm / 1 5/16" |
| Fixture Finish: SSR / BKV / CWI / CRY / HAB / UFT / ITA / RUA / FTG / MYG / LOD / PUS / FRO / FUP / KIA / POP / BLS / SPG / MEY / GOH / GUM / CHC / COM / ABZ / JAG / OBR / MOS / ROR |
| Fixture Material: Aluminum |

ELECTRICAL

| |
|--|
| Lamp Type: LED (Zhaga Standard) |
| Input Wattage (W): 2.2 |
| Total Output Wattage (W): 2 |
| Dimming: Non-Dimming / Phase Dimming (120Vac only) / 0-10V Dimming |
| Driver Included: No |
| Driver Location: Remote |
| Driver Type: Constant Current - 120 / 277Vac |
| Driver Class: Class 2 |
| Input Voltage (V): 120 - 277 |
| Constant Current (MA): 700 |

LED

| |
|---|
| Number of LEDs: 1 |
| Color Temperature (°K): 2700 / 3000 / 3500 / 4000 |
| Max. Delivered Lumen (lm): 30 |
| CRI: >90 CRI |
| Lamp Life (hrs): 50000 |

OPTICAL

RATINGS AND CERTIFICATIONS

| |
|--|
| Certified By: Certified for North American Standards |
| IP rating: IP20 |

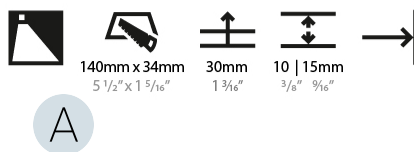

DELIGHT STRING RECESSED

A35696-

PROJECT

TYPE

SPECIFIER

QUANTITY

DATE



A

| |
|-----------|
| PROJECT |
| TYPE |
| SPECIFIER |
| QUANTITY |
| DATE |

DELIGHT STRING RECESSED

A35697-

| | | | |
|-------------|----------------------|-----------------------|------------------------|
| base number | Color Temperature | Finishes (Diamond) | Finishes (Triangle) |
|-------------|----------------------|-----------------------|------------------------|

- To build a product code in our configurator select the specify button on the base model # product page
- To build a manual product code on this datasheet choose from the options listed below in blue font and add the suffix to the base model #

GENERAL

| |
|---------------------------|
| Series: Delight |
| Subseries: Delight String |
| Brand: Prolicht |
| Division: Architectural |
| Mounting Type: Recessed |
| Mounting Location: Wall |
| Subcategory: Step Light |

PHYSICAL

| |
|---|
| Shape: Rectangle |
| Width (mm): 40 |
| Width (in): 1 9/16 |
| Height (mm): 250 |
| Depth (mm): 26 |
| Height (in): 9 13/16 |
| Depth (in): 1 |
| Ceiling Thickness (mm): 10 / 12 / 15 |
| Ceiling Thickness (in): 3/8 or 1/2 or 9/16 |
| Min. Recessing Depth (mm): 30 |
| Min. Recessing Depth (in): 1 3/16 |
| Light Distribution: Asymmetric |
| Weight (kg): .83 |
| Weight (lbs): 1.8 |
| Fixture Finish: SSR / BKV / CWI / CRY / HAB / UFT / ITA / RUA / FTG / MYG / LOD / PUS / FRO / FUP / KIA / POP / BLS / SPG / MEY / GOH / GUM / CHC / COM / ABZ / JAG / OBR / MOS / ROR |
| Fixture Material: Aluminum |
| Cut-out Measurements: 240mm / 9 7/16" x 34mm / 1 5/16" |

ELECTRICAL

| |
|--|
| Lamp Type: LED (Zhaga Standard) |
| Input Wattage (W): 2.2 |
| Total Output Wattage (W): 2 |
| Dimming: Non-Dimming / Phase Dimming (120Vac only) / 0-10V Dimming |
| Driver Included: No |
| Driver Location: Remote |
| Driver Type: Constant Current - 120 / 277Vac |
| Driver Class: Class 2 |
| Input Voltage (V): 120 - 277 |
| Constant Current (MA): 700 |

LED

| |
|---|
| Number of LEDs: 1 |
| Color Temperature (°K): 2700 / 3000 / 3500 / 4000 |
| Max. Delivered Lumen (lm): 30 |
| CRI: >90 CRI |
| Lamp Life (hrs): 50000 |

OPTICAL

RATINGS AND CERTIFICATIONS

| |
|--|
| Certified By: Certified for North American Standards |
| IP rating: IP20 |

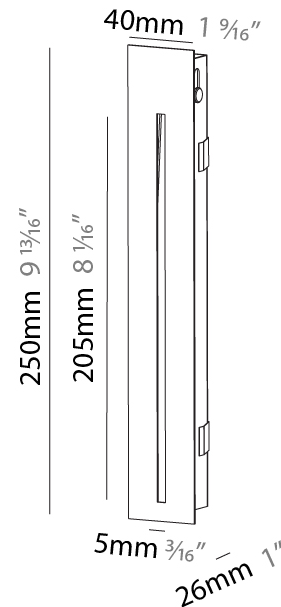

DELIGHT STRING RECESSED

A35697-

PROJECT

TYPE

SPECIFIER

QUANTITY

DATE



A

| | |
|-----------|--|
| PROJECT | |
| TYPE | |
| SPECIFIER | |
| QUANTITY | |
| DATE | |

DELIGHT STRING WIDE RECESSED

A35698-

| | | | |
|-------------|-------------|-----------|------------|
| base number | Color | Finishes | Finishes |
| | Temperature | (Diamond) | (Triangle) |

- To build a product code in our configurator select the specify button on the base model # product page
- To build a manual product code on this datasheet choose from the options listed below in blue font and add the suffix to the base model #

GENERAL

| |
|--------------------------------|
| Series: Delight |
| Subseries: Delight String Wide |
| Brand: Prolicht |
| Division: Architectural |
| Mounting Type: Recessed |
| Mounting Location: Wall |
| Subcategory: Step Light |

PHYSICAL

| |
|---|
| Shape: Rectangle |
| Width (mm): 40 |
| Width (in): 1 9/16 |
| Height (mm): 150 |
| Depth (mm): 26 |
| Height (in): 5 7/8 |
| Depth (in): 1 |
| Ceiling Thickness (mm): 10 / 12 / 15 |
| Ceiling Thickness (in): 3/8 or 1/2 or 9/16 |
| Min. Recessing Depth (mm): 30 |
| Min. Recessing Depth (in): 1 3/16 |
| Light Distribution: Asymmetric |
| Weight (kg): 0.21 |
| Weight (lbs): 0.46 |
| Screws: No visible screws |
| Fixture Finish: SSR / BKV / CWI / CRY / HAB / UFT / ITA / RUA / FTG / MYG / LOD / PUS / FRO / FUP / KIA / POP / BLS / SPG / MEY / GOH / GUM / CHC / COM / ABZ / JAG / OBR / MOS / ROR |
| Fixture Material: Aluminum |
| Cut-out Measurements: 140mm / 5 1/2" x 34mm / 1 5/16" |

ELECTRICAL

| |
|--|
| Lamp Type: LED (Zhaga Standard) |
| Input Wattage (W): 2.2 |
| Total Output Wattage (W): 2 |
| Dimming: Non-Dimming / Phase Dimming (120Vac only) / 0-10V Dimming |
| Driver Included: No |
| Driver Location: Remote |
| Driver Type: Constant Current - 120 / 277Vac |
| Driver Class: Class 2 |
| Input Voltage (V): 120 - 277 |
| Constant Current (MA): 700 |

LED

| |
|---|
| Number of LEDs: 1 |
| Color Temperature (°K): 2700 / 3000 / 3500 / 4000 |
| Max. Delivered Lumen (lm): 60 / 60 / 68 / 70 |
| CRI: >90 CRI |
| Lamp Life (hrs): 50000 |

OPTICAL

RATINGS AND CERTIFICATIONS

| |
|--|
| Certified By: Certified for North American Standards |
| IP rating: IP20 |

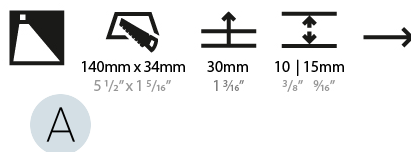
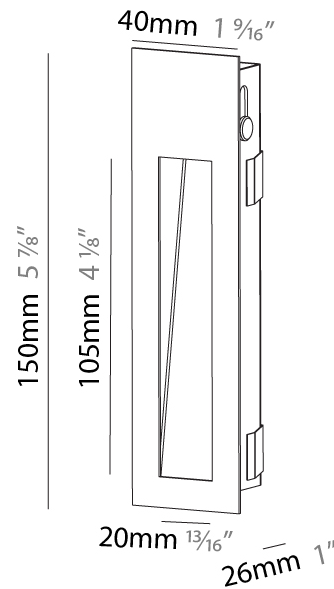

DELIGHT STRING WIDE RECESSED

A35698-

PROJECT

TYPE

SPECIFIER

QUANTITY

DATE

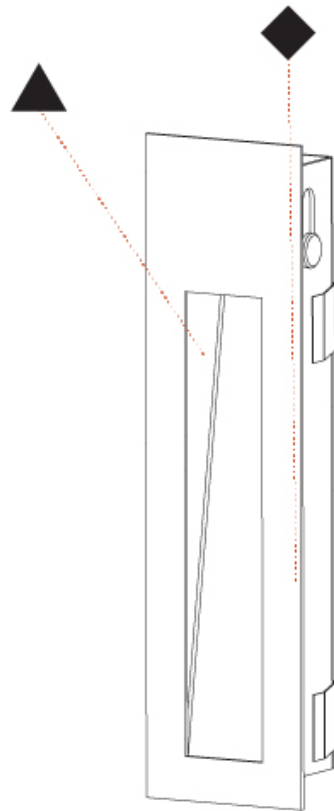

A

DELIGHT STRING WIDE RECESSED

A35699-

base number Color Finishes Finishes
 Temperature (Diamond) (Triangle)

- To build a product code in our configurator select the specify button on the base model # product page
- To build a manual product code on this datasheet choose from the options listed below in blue font and add the suffix to the base model #

GENERAL

Series: Delight
 Subseries: Delight String Wide
 Brand: Prolicht
 Division: Architectural
 Mounting Type: Recessed
 Mounting Location: Wall
 Subcategory: Step Light

PHYSICAL

Shape: Rectangle
 Length (mm): 250
 Length (in): 9 ¹³/₁₆
 Width (mm): 40
 Width (in): 1 ⁹/₁₆
 Height (mm): 250
 Depth (mm): 26
 Height (in): 9 ¹³/₁₆
 Depth (in): 1
 Ceiling Thickness (mm): 10 / 12 / 15
 Ceiling Thickness (in): 3/8 or 1/2 or 9/16
 Min. Recessing Depth (mm): 30
 Min. Recessing Depth (in): 1 ³/₁₆
 Light Distribution: Asymmetric
 Weight (kg): .83
 Weight (lbs): 1.8
 Fixture Finish: SSR / BKV / CWI / CRY / HAB / UFT / ITA / RUA / FTG / MYG / LOD / PUS / FRO / FUP / KIA / POP / BLS / SPG / MEY / GOH / GUM / CHC / COM / ABZ / JAG / OBR / MOS / ROR
 Fixture Material: Aluminum
 Cut-out Measurements: 240mm / 9 7/16" x 34mm / 1 5/16"

ELECTRICAL

Lamp Type: LED (Zhaga Standard)
 Input Wattage (W): 2.2
 Total Output Wattage (W): 2
 Dimming: 0-10V Dimming / Phase Dimming (120Vac Only)
 Driver Included: No
 Driver Location: Remote
 Driver Type: Constant Current - 120 / 277Vac
 Driver Class: Class 2
 Input Voltage (V): 120 - 277
 Constant Current (MA): 700

LED

Number of LEDs: 1
 Color Temperature (°K): 2700 / 3000 / 3500 / 4000
 Max. Delivered Lumen (lm): 60 / 60 / 68 / 70
 CRI: >90 CRI
 Lamp Life (hrs): 50000

OPTICAL

RATINGS AND CERTIFICATIONS

Certified By: Certified for North American Standards
 IP rating: IP20

| |
|-----------|
| PROJECT |
| TYPE |
| SPECIFIER |
| QUANTITY |
| DATE |

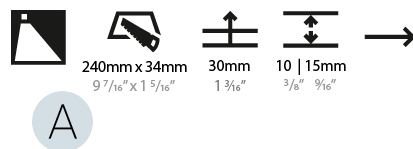
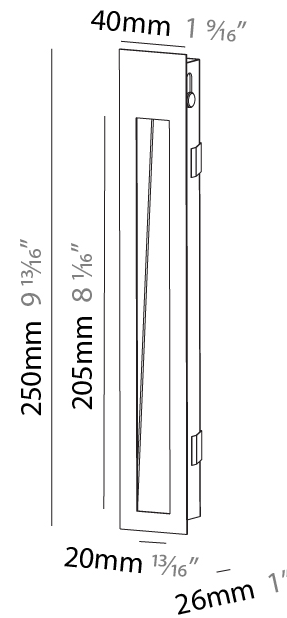

DELIGHT STRING WIDE RECESSED

A35699-

PROJECT

TYPE

SPECIFIER

QUANTITY

DATE

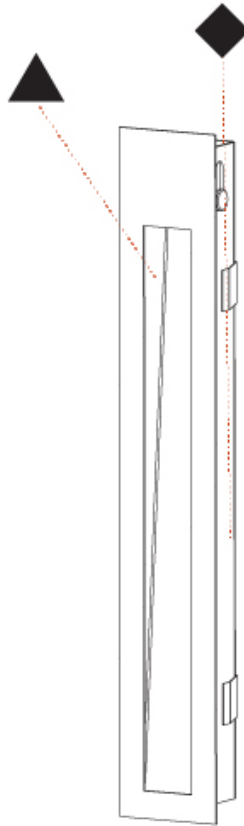

A

DELIGHT COLOR FINISH CHART

| |
|-----------|
| PROJECT |
| TYPE |
| SPECIFIER |
| QUANTITY |
| DATE |

Fixture Finish



Digital: Not all screens are calibrated the same, and therefore, colors will appear differently between screens.

Physical: When texture is involved, there will be variations in color, character and tone within a product series and between product families.

Gun Metal: No Gun Metal finish is alike. It combines a mixture of transparent and black color particles which ensures a highly individual effect and no luminaire being identical.

Champagne Cream, Copper Mine, Ancient Bronze + Jazz Gold: These finishes have slight fading from specific powder coating production. Each luminaire will slightly vary.



| | |
|-----------|--|
| PROJECT | |
| TYPE | |
| SPECIFIER | |
| QUANTITY | |
| DATE | |

LEGEND

| | | | | | |
|--|---|--|--|--|--|
| | floor-mounted | | pivotable | | special LED (upon request) RGB, RGBW, tunable, gold+, meat+, art+, fashion+ |
| | wall and ceiling: recessed and surface mounted | | rotating | | warm dim / natural dimming LED |
| | ceiling-mounted and wall-mounted | | illuminate tilted | | rechargeable battery powered |
| | wall-mounted | | color of suspension cable | | fixture with natural vivid LED (upon request) |
| | omni-directional light distribution | | length of suspension cable | | color rendering index |
| | direct light distribution | | reflector degree selection | | color temperature |
| | direct/indirect light distribution | | super spot | | lumen (luminous flux) |
| | indirect light distribution | | lens | | efficacy (lumens per watt) |
| | asymmetric light distribution | | lens pack | | Unified Glare Rating (UGR) range from 5-40 |
| | aura light distribution | | shine ring | | marine grade (AISI 316 stainless steel) |
| | round wall or ceiling cut-out | | integrated shine ring with diffuser | | walk on |
| | square wall or ceiling cut-out | | free individual colors 01-29 | | drive on |
| | the supplied jig specifies the cutout dimensions | | individual colors: 00 (free of charge), 01-25 (extra charge) | | Dark Sky Compliance |
| | minimum distance (meters) lamp - object | | luminaire part to be colored (F1) | | Americans with Disabilities Act (less than 4" off the wall located between 27"-84" from floor) |
| | recessed depth | | luminaire part to be colored (F2) | | lamp protected against explosion |
| | ceiling thickness in mm | | luminaire part to be colored (F3) | | blown glass using traditional methods by master glass blower |
| | ceiling thickness selection | | luminaire part to be colored (F4) | | acoustic material |
| | dimmable DP (phase), DV (0-10V), DD (dali), DS (step-dim) | | luminaire part to be colored (F5) | | protection class I, protection insulation |
| | included or excluded LED driver/transformer/control gear | | color of 3-circuit adaptor | | protection class II, protection insulation |
| | separately switchable | | indirect diffuser | | ETL Certified to UL and CSA Standards |
| | sensor | | direct diffuser | | UL Certified to UL and CSA Standards |
| | remote control | | ball-proof (upon request) | | CSA Certified to UL and CSA Standards |
| | available upon request | | accessory | | Certified for North American Standards |

IP RATING

| | |
|--|--|
| | protected against ingress of solid bodies greater than 12.5mm (finger) |
| | protected against ingress of solid bodies greater than 2.5mm protected against sprays of water up to 60 degrees from the vertical (rain) |
| | protected against ingress of solid bodies greater than 1mm (wire) no protection against the ingress of moisture |
| | protected against ingress of solid bodies greater than 1mm (wire) protected against sprays of water up to 60 degrees from the vertical (rain) |
| | protected against ingress of solid bodies greater than 1mm (wire) protected against water splashed from all directions |
| | protected against limited ingress of dust (wet rooms/covered outdoor areas) protected against water splashed from all directions |
| | protected against ingress of dust protected against jets of water |
| | protected against ingress of dust protected against powerful jets of water or heavy seas |
| | protected against ingress of dust protected against immersion of water between 15cm - 1m for 30 minutes |
| | protected against ingress of dust protected against immersion of water under pressure for long periods |

IK RATING

| | |
|--|---|
| | protected against 0.14 joules impact (equivalent to 0.25kg mass dropped from 56mm above the surface) |
| | protected against 0.2 joules impact (equivalent to 0.25kg mass dropped from 80mm above the surface) |
| | protected against 0.35 joules impact (equivalent to 0.25kg mass dropped from 140mm above the surface) |
| | protected against 0.5 joules impact (equivalent to 0.25kg mass dropped from 200mm above the surface) |
| | protected against 0.7 joules impact (equivalent to 0.25kg mass dropped from 280mm above the surface) |
| | protected against 1 joules impact (equivalent to 0.25kg mass dropped from 400mm above the surface) |
| | protected against 2 joules impact (equivalent to 0.5kg mass dropped from 400mm above the surface) |
| | protected against 5 joules impact (equivalent to 1.7kg mass dropped from 300mm above the surface) |
| | protected against 10 joules impact (equivalent to 5.0kg mass dropped from 200mm above the surface) |
| | protected against 20 joules impact (equivalent to 5.0kg mass dropped from 400mm above the surface) |