

DIXIT RECESSED

A5601121-

base number Color
Temperature

1. To build a product code in our configurator select the specify button on the base model # product page
2. To build a manual product code on this datasheet choose from the options listed below in blue font and add the suffix to the base model #

GENERAL

Series: Dixit
Brand: Ivela
Division: Architectural
Mounting Type: Recessed
Mounting Location: Ceiling
Subcategory: Downlight

PHYSICAL

Shape: Round
Diameter (mm): 95
Diameter (in): 3 3/4
Depth (mm): 82
Depth (in): 3 1/4
Min. Recessing Depth (mm): 122
Min. Recessing Depth (in): 4 13/16
Light Distribution: Adjustable / Direct
Weight (kg): 0.4
Weight (lbs): 0.88
Cut-out Measurements: 86mm / 3 3/8

ELECTRICAL

Lamp Type: LED
Total Output Wattage (W): 12
Dimming: Tri-Mode (Non-Dimming and Phase Dimming (120Vac only) and 0-10V Dimming)
Driver Included: No
Driver Location: Recessed Housing
Driver Type: Constant Current - Universal
Driver Class: Class 2
Input Voltage (V): 120 - 277
Constant Current (MA): 350

LED

Number of LEDs: 1
Color Temperature (°K): 2700 / 3000 / 4000
Max. Delivered Lumen (lm): 1447
CRI: >80 CRI
Efficiency (%): 91
Lamp Life (hrs): 50000

OPTICAL

Optic°: 26
Adjustability: Tilt 20°
Upon Request: Optic 45° (mirror-metallized) / 65° (white)

RATINGS AND CERTIFICATIONS

Certified By: CSA Certified to UL and CSA Standards
IP rating: IP20
IK Rating: IK08
Glare Rating: ≤ 19



DIXIT RA11 RECESSED

A56020-

base number _____ Color _____
Temperature _____

PROJECT	_____
TYPE	_____
SPECIFIER	_____
QUANTITY	_____
DATE	_____

- To build a product code in our configurator select the specify button on the base model # product page
- To build a manual product code on this datasheet choose from the options listed below in blue font and add the suffix to the base model #

GENERAL

Series: Dixit
Subseries: Dixit RA11
Brand: Ivela
Division: Architectural
Mounting Type: Recessed
Mounting Location: Ceiling
Subcategory: Downlight

PHYSICAL

Shape: Round
Diameter (mm): 110
Diameter (in): 4 5/16
Height (mm): 70
Height (in): 2 3/4
Min. Recessing Depth (mm): 110
Min. Recessing Depth (in): 4 15/16
Light Distribution: Direct
Weight (kg): 0.6
Weight (lbs): 1.32
Diffuser: Clear Polycarbonate
Fixture Finish: MWH
Fixture Material: Aluminum Die Cast
Cut-out Measurements: 100mm / 3 15/16"

ELECTRICAL

Lamp Type: LED
Total Output Wattage (W): 12 / 18 / 26
Dimming: Tri-Mode (Non-Dimming and Phase Dimming (120Vac only) and 0-10V Dimming)
Driver Included: No
Driver Location: Recessed Housing
Driver Type: Constant Current - Universal
Driver Class: Class 2
Input Voltage (V): 120 - 277
Constant Current (MA): 350 / 500 / 700

LED

Number of LEDs: 1
Color Temperature (°K): 2700 / 3000 / 4000
Max. Delivered Lumen (lm): 1513 / 2092 / 2759
CRI: >85 CRI
Efficiency (%): 89
Lamp Life (hrs): 50000
Upon Request: 3500K upon request

OPTICAL

Optic°: 55
Adjustability: Fixed
Upon Request: Optic 18° or 30° (mirror-metallized) / 70° (white)

RATINGS AND CERTIFICATIONS

Certified By: Certified for North American Standards
IP rating: IP43
IK Rating: IK08
Glare Rating: ≤ 19

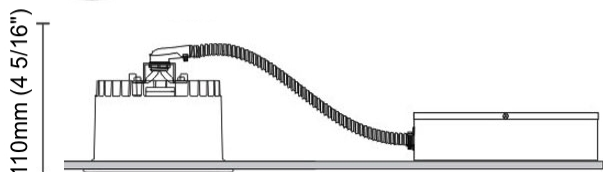
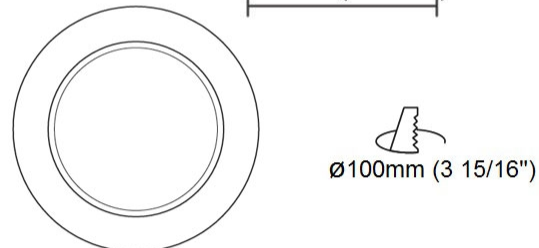
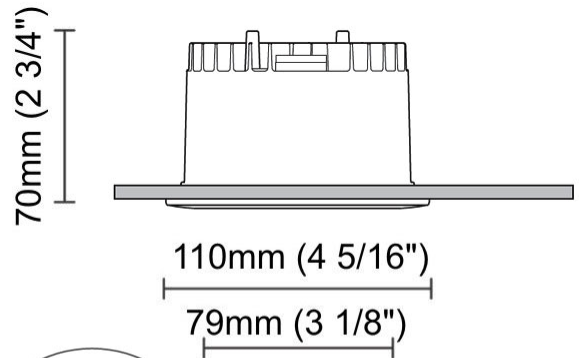

DIXIT RA11 RECESSED

A56020-

PROJECT	
TYPE	
SPECIFIER	
QUANTITY	
DATE	

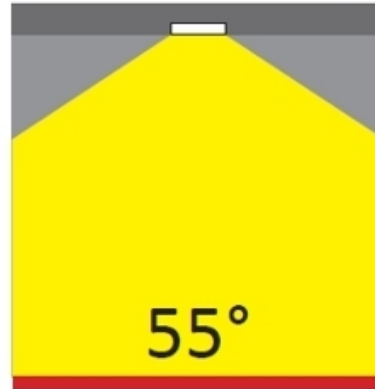
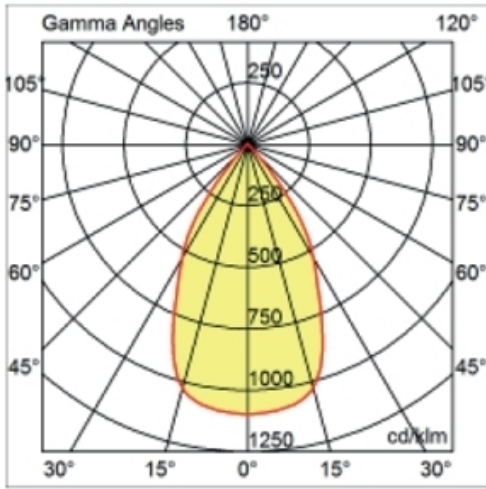

RA 11 DIXIT LED 12W 1700LM 3000K				R:100%		I.Max:1096 Cd/Klm					
H[m]	D[m]	Max lux	Med lux	Alpha=55°		H[m]	D[m]	Max lux	Med lux	Beta=55°	
1.00	1.13	1658	898			1.00	1.13	1658	898		
2.00	2.26	415	224			2.00	2.26	415	224		
3.00	3.38	184	100			3.00	3.38	184	100		
4.00	4.51	104	56			4.00	4.51	104	56		
5.00	5.64	66	36			5.00	5.64	66	36		

	DP	DV	
Dimming	Phase	0-10V	
Color Temperature	27K 30K 35K 40K	2700K 3000K 3500K 4000K	K°

Order Example **L5XXXXXX-DV-30K**

0-10V 3000K



DIXIT RA11 RECESSED

A56024-

base number Color
Temperature

- To build a product code in our configurator select the specify button on the base model # product page
- To build a manual product code on this datasheet choose from the options listed below in blue font and add the suffix to the base model #

GENERAL

Series: Dixit
 Subseries: Dixit RA11
 Brand: Ivela
 Division: Architectural
 Mounting Type: Recessed
 Mounting Location: Ceiling
 Subcategory: Downlight

PHYSICAL

Shape: Round
 Diameter (mm): 125
 Diameter (in): 4 ¹⁵/₁₆
 Height (mm): 79
 Height (in): 3 ¹/₈
 Min. Recessing Depth (mm): 119
 Min. Recessing Depth (in): 4 ¹¹/₁₆
 Light Distribution: Direct
 Weight (kg): 0.6
 Weight (lbs): 1.32
 Diffuser: Clear Polycarbonate
 Fixture Finish: MWH
 Fixture Material: Aluminum Die Cast
 Cut-out Measurements: 116mm / 4 9/16"

ELECTRICAL

Lamp Type: LED
 Total Output Wattage (W): 12 / 18 / 26
 Dimming: Tri-Mode (Non-Dimming and Phase Dimming (120Vac only) and 0-10V Dimming)
 Driver Included: No
 Driver Location: Recessed Housing
 Driver Type: Constant Current - Universal
 Driver Class: Class 2
 Input Voltage (V): 120 - 277
 Constant Current (mA): 350 / 500 / 700

LED

Number of LEDs: 1
 Color Temperature (°K): 2700 / 3000 / 4000
 Max. Delivered Lumen (lm): 1513 - 1602 / 2092 - 2180 / 2759 - 2848
 CRI: >85 CRI
 Efficiency (%): 89
 Lamp Life (hrs): 50000
 Upon Request: 3500K upon request

OPTICAL

Optic°: 55
 Adjustability: Tilt ±20°
 Upon Request: Optic 18° or 30° (mirror-metallized) / 70° (white)

RATINGS AND CERTIFICATIONS

Certified By: Certified for North American Standards
 IP rating: IP20
 IK Rating: IK08
 Glare Rating: ≤ 19

PROJECT
TYPE
SPECIFIER
QUANTITY
DATE

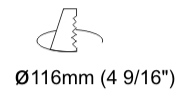
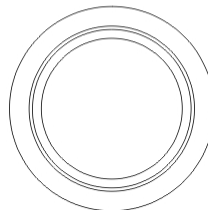
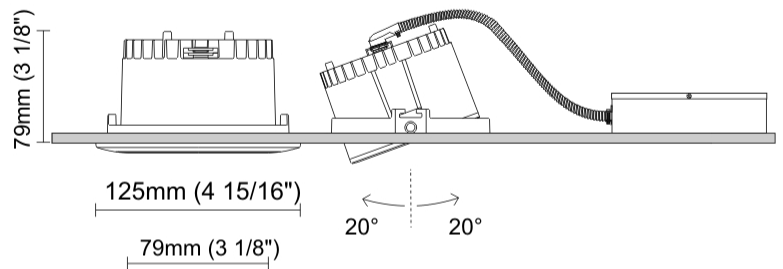

DIXIT RA11 RECESSED

A56024-

PROJECT	
TYPE	
SPECIFIER	
QUANTITY	
DATE	

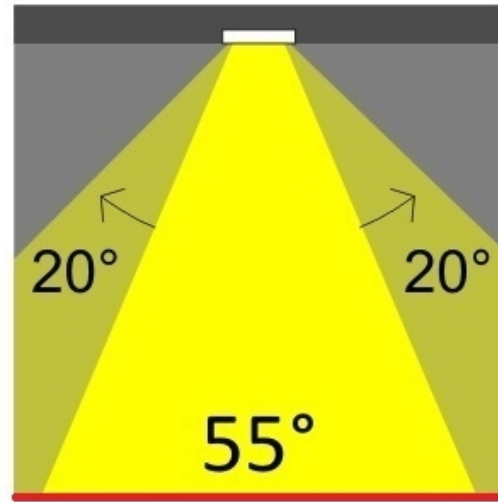
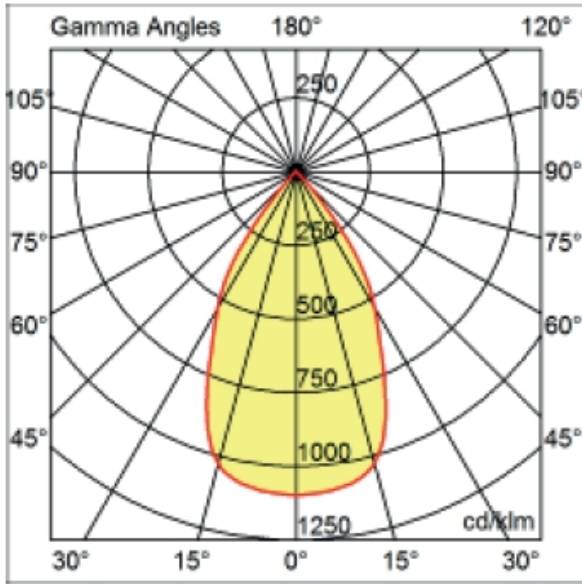

	DP	DV		
Dimming	Phase	0-10V		
Color Temperature	27K	30K	35K	40K
	2700K	3000K	3500K	4000K

Order Example  **K°**
L5XXXXXX-DV-30K
 0-10V
 3000K



PROJECT	_____
TYPE	_____
SPECIFIER	_____
QUANTITY	_____
DATE	_____

DIXIT RA11 RECESSED

A56028-

base number _____ Color _____
Temperature _____

- To build a product code in our configurator select the specify button on the base model # product page
- To build a manual product code on this datasheet choose from the options listed below in blue font and add the suffix to the base model #

GENERAL

Series: Dixit
Subseries: Dixit RA11
Brand: Ivela
Division: Architectural
Mounting Type: Recessed
Mounting Location: Ceiling
Subcategory: Downlight

PHYSICAL

Shape: Round
Diameter (mm): 126
Diameter (in): 4 15/16
Height (mm): 104
Height (in): 4 1/8
Min. Recessing Depth (mm): 144
Min. Recessing Depth (in): 5 11/16
Light Distribution: Direct
Weight (kg): 0.6
Weight (lbs): 1.32
Diffuser: Clear Polycarbonate
Fixture Finish: MWH
Fixture Material: Aluminum Die Cast
Cut-out Measurements: 122mm / 4 13/16"

ELECTRICAL

Lamp Type: LED
Total Output Wattage (W): 12 / 18 / 26
Dimming: Tri-Mode (Non-Dimming and Phase Dimming (120Vac only) and 0-10V Dimming)
Driver Included: No
Driver Location: Recessed Housing
Driver Type: Constant Current - Universal
Driver Class: Class 2
Input Voltage (V): 120 - 277
Constant Current (MA): 350 / 500 / 700

LED

Number of LEDs: 1
Color Temperature (°K): 2700 / 3000 / 4000
Max. Delivered Lumen (lm): 1513 - 1602 / 2092 - 2180 / 2759 - 2848
CRI: >85 CRI
Efficiency (%): 89
Lamp Life (hrs): 50000
Upon Request: 3500K upon request

OPTICAL

Optic°: 55
Adjustability: Fixed
Upon Request: Optic 18° or 30° (mirror-metallized) / 70° (white)

RATINGS AND CERTIFICATIONS

Certified By: Certified for North American Standards
IP rating: IP43
IK Rating: IK08
Glare Rating: ≤ 19

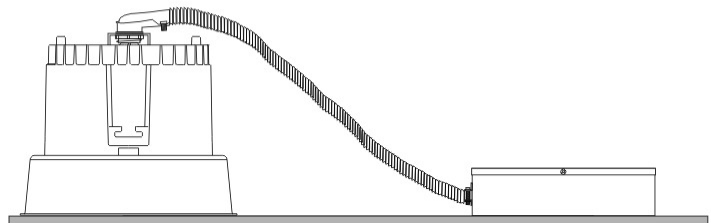
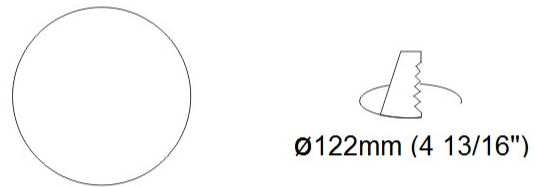
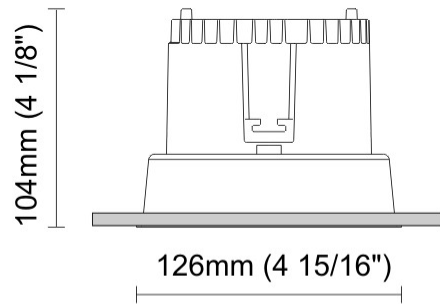

DIXIT RA11 RECESSED

A56028-

PROJECT	
TYPE	
SPECIFIER	
QUANTITY	
DATE	

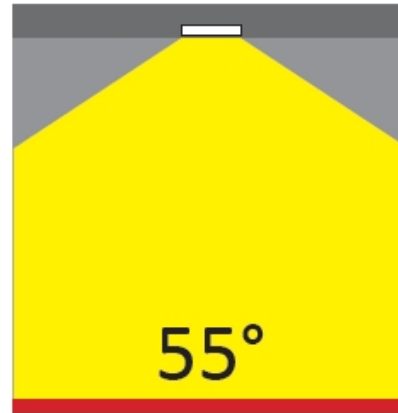
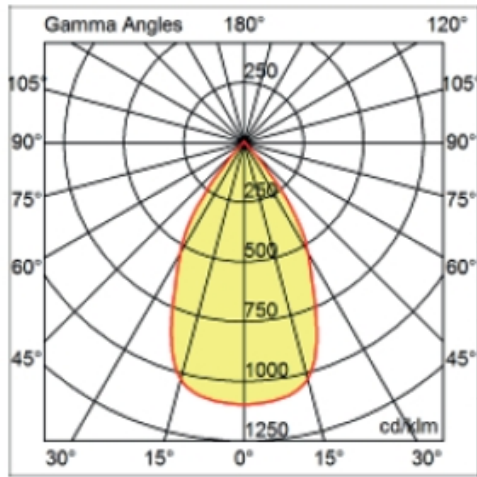

	DP	DV		Order Example	K°
Dimming	Phase	0-10V		L5XXXXXX-DV-30K	
Color Temperature	27K	30K	35K	0-10V	3000K
	2700K	3000K	3500K		

A

DIXIT RA11 RECESSED

A56032-

base number _____ Color _____
 Temperature _____

PROJECT	_____
TYPE	_____
SPECIFIER	_____
QUANTITY	_____
DATE	_____

- To build a product code in our configurator select the specify button on the base model # product page
- To build a manual product code on this datasheet choose from the options listed below in blue font and add the suffix to the base model #

GENERAL

Series: Dixit
 Subseries: Dixit RA11
 Brand: Ivela
 Division: Architectural
 Mounting Type: Recessed
 Mounting Location: Ceiling
 Subcategory: Downlight

PHYSICAL

Shape: Round
 Diameter (mm): 141
 Diameter (in): 5 5/16
 Height (mm): 117
 Height (in): 4 5/8
 Min. Recessing Depth (mm): 157
 Min. Recessing Depth (in): 6 3/16
 Light Distribution: Direct
 Weight (kg): 0.7
 Weight (lbs): 1.54
 Diffuser: Clear Polycarbonate
 Fixture Finish: MWH
 Fixture Material: Aluminum Die Cast
 Cut-out Measurements: 126mm / 4 15/16"

ELECTRICAL

Lamp Type: LED
 Total Output Wattage (W): 12 / 18 / 26
 Dimming: Tri-Mode (Non-Dimming and Phase Dimming (120Vac only) and 0-10V Dimming)
 Driver Included: No
 Driver Location: Recessed Housing
 Driver Type: Constant Current - Universal
 Driver Class: Class 2
 Input Voltage (V): 120 - 277
 Constant Current (MA): 350 / 500 / 700

LED

Number of LEDs: 1
 Color Temperature (°K): 2700 / 3000
 Max. Delivered Lumen (lm): 1513 / 2092
 CRI: >85 CRI
 Efficiency (%): 89
 Lamp Life (hrs): 50000
 Upon Request: 3500K upon request

OPTICAL

Optic°: 55
 Adjustability: Fixed
 Upon Request: Optic 12° or 30° (mirror-metallized) / 70° (white)

RATINGS AND CERTIFICATIONS

Certified By: CSA Certified to UL and CSA Standards
 IP Rating: IP43
 IK Rating: IK08
 Glare Rating: ≤ 19

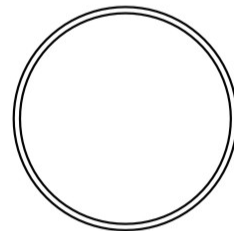
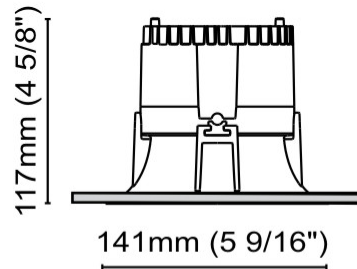

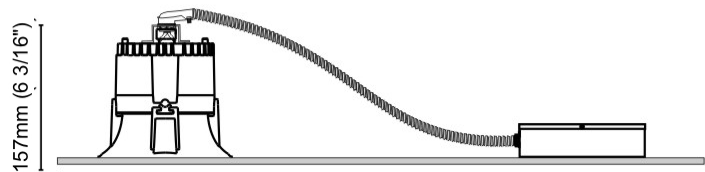

 126mm (4 15/16")



DIXIT RA11 RECESSED

A56032-

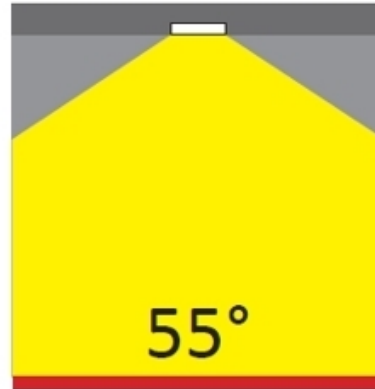
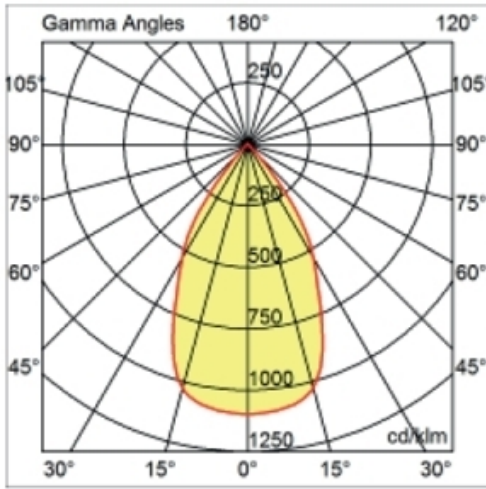
PROJECT	
TYPE	
SPECIFIER	
QUANTITY	
DATE	



RA 11 DIXIT LED SOFT 12W 1700 lm 3000K					R:100%		I.Max:1293 Cd/Kim			
H[m]	D[m]	Max lux	Med lux	Alpha=54°	H[m]	D[m]	Max lux	Med lux	Beta=54°	
1.00	1.02	1913	1003		1.00	1.02	1913	1003		
2.00	2.04	478	251		2.00	2.04	478	251		
3.00	3.06	213	111		3.00	3.06	213	111		
4.00	4.08	120	63		4.00	4.08	120	63		
5.00	5.10	77	40		5.00	5.10	77	40		

Dimming	DP	DV	
	Phase	0-10V	
Color Temperature	27K	30K	35K
	2700K	3000K	3500K

Order Example **K°**

L5XXXXXX-DV-30K

0-10V

3000K



DIXIT RA11 RECESSED

A56051- _____
base number

PROJECT	_____
TYPE	_____
SPECIFIER	_____
QUANTITY	_____
DATE	_____

- To build a product code in our configurator select the specify button on the base model # product page
- To build a manual product code on this datasheet choose from the options listed below in blue font and add the suffix to the base model #

GENERAL

Series: Dixit
Subseries: Dixit RA11
Brand: Ivela
Division: Architectural
Mounting Type: Recessed
Mounting Location: Ceiling
Subcategory: Downlight

PHYSICAL

Shape: Square
Length (mm): 117
Length (in): 4 5/8
Width (mm): 117
Width (in): 4 5/8
Height (mm): 73
Height (in): 2 7/8
Min. Recessing Depth (mm): 113
Min. Recessing Depth (in): 4 1/2
Light Distribution: Direct
Weight (kg): 0.7
Weight (lbs): 1.54
Diffuser: Clear Polycarbonate
Fixture Finish: MWH
Fixture Material: Aluminum Die Cast
Cut-out Measurements: 100mm / 3 15/16"

ELECTRICAL

Lamp Type: LED
Total Output Wattage (W): 12 / 18 / 26
Dimming: Tri-Mode (Non-Dimming and Phase Dimming (120Vac only) and 0-10V Dimming)
Driver Included: No
Driver Location: Recessed Housing
Driver Type: Constant Current - Universal
Driver Class: Class 2
Input Voltage (V): 120 - 277
Constant Current (MA): 350 / 500 / 700

LED

Number of LEDs: 1
Color Temperature (°K): 2700 / 3000 / 4000
Max. Delivered Lumen (lm): 1513 - 1602 / 2092 - 2180 / 2759 - 2848
CRI: >85 CRI
Efficiency (%): 89
Lamp Life (hrs): 50000
Upon Request: 3500K upon request

OPTICAL

Optic°: 55
Adjustability: Fixed
Upon Request: Optic 12° or 30° (mirror-metallized) / 70° (white)

RATINGS AND CERTIFICATIONS

Certified By: Certified for North American Standards
IP rating: IP43
IK Rating: IK08
Glare Rating: ≤ 19

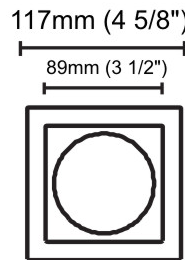
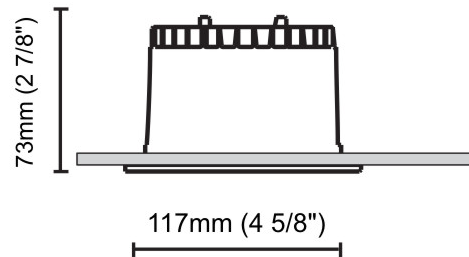

Ø100mm (3 15/16")

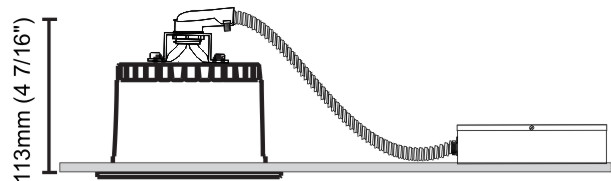



DIXIT RA11 RECESSED

A56051-

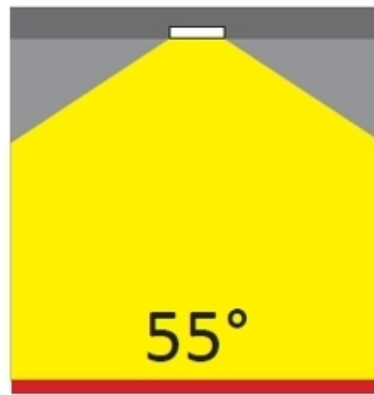
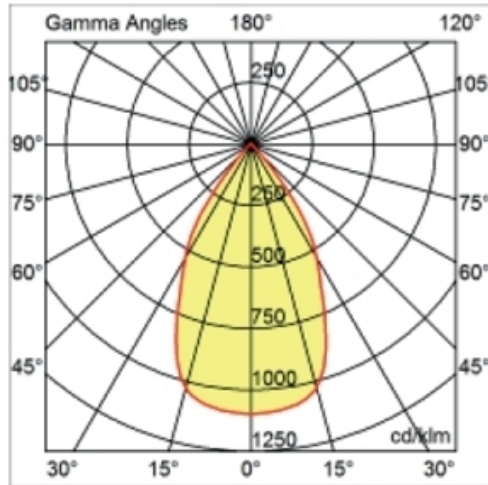
PROJECT	
TYPE	
SPECIFIER	
QUANTITY	
DATE	



	DP	DV	
Dimming	Phase	0-10V	
Color Temperature	27K 2700K	30K 3000K	35K 3500K
		40K 4000K	K°

Order Example  **K°**
L5XXXXXX-DV-30K
 0-10V
 3000K



DIXIT RA8 RECESSED

A56057-

base number Color
Temperature

PROJECT	_____
TYPE	_____
SPECIFIER	_____
QUANTITY	_____
DATE	_____

- To build a product code in our configurator select the specify button on the base model # product page
- To build a manual product code on this datasheet choose from the options listed below in blue font and add the suffix to the base model #

GENERAL

Series: Dixit
Subseries: Dixit RA8
Brand: Ivela
Division: Architectural
Mounting Type: Recessed
Mounting Location: Ceiling
Subcategory: Downlight

PHYSICAL

Shape: Square
Length (mm): 80
Length (in): 3 1/8"
Width (mm): 80
Width (in): 3 1/8"
Height (mm): 70
Height (in): 2 3/4"
Min. Recessing Depth (mm): 110
Min. Recessing Depth (in): 4 3/16"
Light Distribution: Direct
Weight (kg): 0.4
Weight (lbs): 0.88
Diffuser: Clear Polycarbonate
Fixture Finish: MWH
Fixture Material: Aluminum Die Cast
Cut-out Measurements: 70mm / 2 3/4"

ELECTRICAL

Lamp Type: LED
Total Output Wattage (W): 9 / 12
Dimming: Tri-Mode (Non-Dimming and Phase Dimming (120Vac only) and 0-10V Dimming)
Driver Included: No
Driver Location: Recessed Housing
Driver Type: Constant Current - Universal
Driver Class: Class 2
Input Voltage (V): 120 - 277
Constant Current (MA): 250 / 350

LED

Number of LEDs: 1
Color Temperature (°K): 2700 / 3000
Max. Delivered Lumen (lm): 1096 / 1447
CRI: >80 CRI
Efficiency (%): 87.7
Lamp Life (hrs): 50000
Upon Request: 3500K upon request

OPTICAL

Optic°: 26
Adjustability: Fixed
Upon Request: Optic 45° (mirror-metallized) / 65° (white)

RATINGS AND CERTIFICATIONS

Certified By: Certified for North American Standards
IP rating: IP44
IK Rating: IK08
Glare Rating: ≤ 19

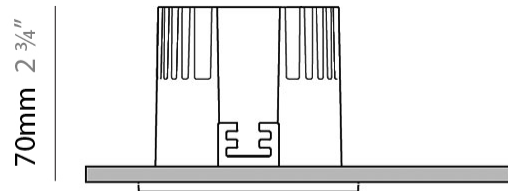

80mm 3 1/8"

51mm 2"

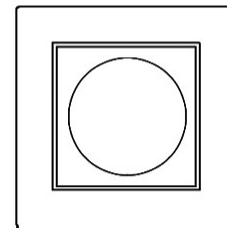

4 5/16"
110mm





DIXIT RA8 RECESSED

A56057-

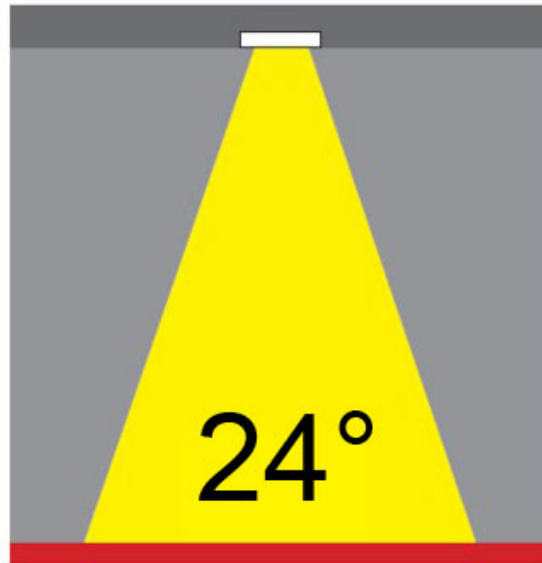
PROJECT
TYPE
SPECIFIER
QUANTITY
DATE



	DP	DV		Order Example		K°
Dimming	Phase	0-10V		L5XXXXXX-DV-30K		
Color Temperature	27K	30K	35K	40K		K°
	2700K	3000K	3500K	4000K	0-10V	3000K



DIXIT RA8 RECESSED

A56061-

base number _____ Color _____
 Temperature _____

- To build a product code in our configurator select the specify button on the base model # product page
- To build a manual product code on this datasheet choose from the options listed below in blue font and add the suffix to the base model #

GENERAL

Series: Dixit
 Subseries: Dixit RA8
 Brand: Ivela
 Division: Architectural
 Mounting Type: Recessed
 Mounting Location: Ceiling
 Subcategory: Downlight

PHYSICAL

Shape: Round
 Diameter (mm): 96
 Diameter (in): 3 ¾
 Height (mm): 85
 Height (in): 3 ⅜
 Min. Recessing Depth (mm): 125
 Min. Recessing Depth (in): 4 15/16
 Light Distribution: Direct
 Weight (kg): 0.3
 Weight (lbs): 0.66
 Diffuser: Clear Polycarbonate
 Fixture Finish: MWH
 Fixture Material: Aluminum Die Cast
 Cut-out Measurements: 92mm / 3 5/8"

ELECTRICAL

Lamp Type: LED
 Total Output Wattage (W): 5.5 / 8.5
 Dimming: Tri-Mode (Non-Dimming and Phase Dimming (120Vac only) and 0-10V Dimming)
 Driver Included: No
 Driver Location: Recessed Housing
 Driver Type: Constant Current - Universal
 Driver Class: Class 2
 Input Voltage (V): 120 - 277
 Constant Current (MA): 350 / 500

LED

Number of LEDs: 1
 Color Temperature (°K): 2700 / 3000
 Max. Delivered Lumen (lm): 501 / 638
 CRI: >90 CRI
 Efficiency (%): 87.7
 Lamp Life (hrs): 50000
 Upon Request: 3500K upon request

OPTICAL

Optic°: 26
 Beam Angle: Symmetric
 Adjustability: Fixed
 Upon Request: Optic 45° (mirror-metallized) / 65° (white)

RATINGS AND CERTIFICATIONS

Certified By: Certified for North American Standards
 IP rating: IP44
 IK Rating: IK08

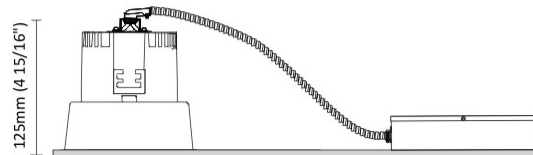
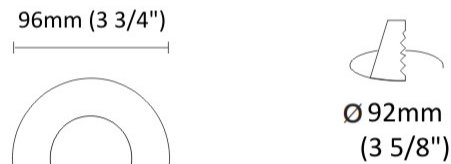
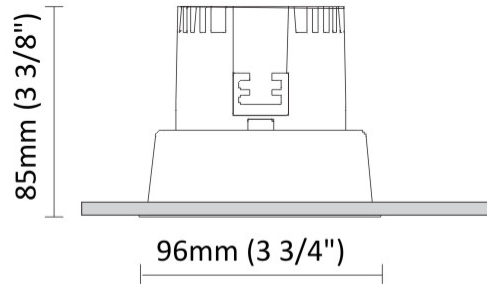

DIXIT RA8 RECESSED

A56061-

PROJECT	
TYPE	
SPECIFIER	
QUANTITY	
DATE	

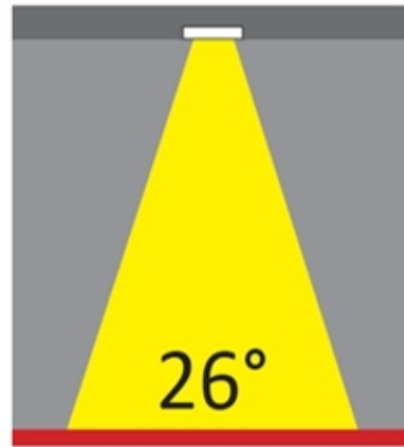
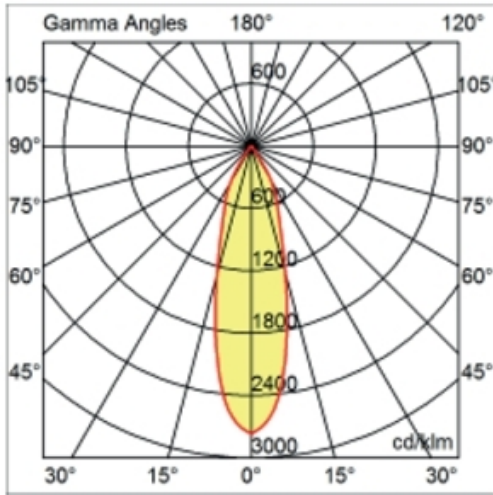

RA 8 TL DIXIT LED 6.5W 550 lm				R:100%				I.Max:2958 Cd/Klm			
H[m]	D[m]	Max lux	Med lux	Alpha=26°		H[m]	D[m]	Max lux	Med lux	Beta=26°	
1.00	0.47	1508	939			1.00	0.47	1508	939		
2.00	0.94	377	235			2.00	0.94	377	235		
3.00	1.41	168	104			3.00	1.41	168	104		
4.00	1.89	94	59			4.00	1.89	94	59		
5.00	2.36	60	38			5.00	2.36	60	38		

Dimming	DP	DV	K°
	Phase	0-10V	
Color Temperature	27K	30K	K°
	2700K	3000K	

Order Example **L5XXXXXX-DV-30K**

0-10V **3000K**



PROJECT	_____
TYPE	_____
SPECIFIER	_____
QUANTITY	_____
DATE	_____

DIXIT RA8 RECESSED

A56063-

base number _____
 Color _____
 Temperature _____

- To build a product code in our configurator select the specify button on the base model # product page
- To build a manual product code on this datasheet choose from the options listed below in blue font and add the suffix to the base model #

GENERAL

Series: Dixit
 Subseries: Dixit RA8
 Brand: Ivela
 Division: Architectural
 Mounting Type: Recessed
 Mounting Location: Ceiling
 Subcategory: Downlight

PHYSICAL

Shape: Round
 Diameter (mm): 96
 Diameter (in): 3 3/4
 Height (mm): 110
 Height (in): 4 5/16
 Min. Recessing Depth (mm): 150
 Min. Recessing Depth (in): 5 7/8
 Light Distribution: Direct
 Weight (kg): 0.4
 Weight (lbs): 0.88
 Diffuser: Clear Polycarbonate
 Fixture Finish: MWH
 Fixture Material: Aluminum Die Cast
 Cut-out Measurements: 92mm / 3 5/8"

ELECTRICAL

Lamp Type: LED
 Total Output Wattage (W): 9 / 12
 Dimming: Tri-Mode (Non-Dimming and Phase Dimming (120Vac only) and 0-10V Dimming)
 Driver Included: No
 Driver Location: Recessed Housing
 Driver Type: Constant Current - Universal
 Driver Class: Class 2
 Input Voltage (V): 120 - 277
 Constant Current (MA): 250 / 350

LED

Number of LEDs: 1
 Color Temperature (°K): 2700 / 3000
 Max. Delivered Lumen (lm): 1096 / 1447
 CRI: >80 CRI
 Efficiency (%): 87.7
 Lamp Life (hrs): 50000
 Upon Request: 3500K upon request

OPTICAL

Optic°: 26
 Beam Angle: Symmetric
 Adjustability: Fixed
 Upon Request: Optic 45° (mirror-metallized) / 65° (white)

RATINGS AND CERTIFICATIONS

Certified By: Certified for North American Standards
 IP rating: IP44
 IK Rating: IK08

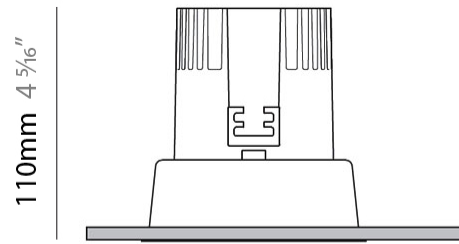

Ø96mm 3 3/4"

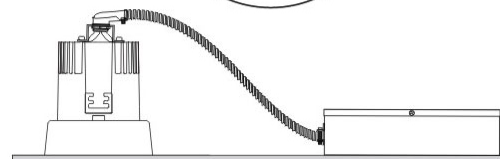
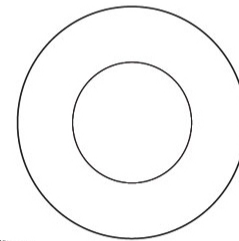

DIXIT RA8 RECESSED

A56063-

PROJECT
TYPE
SPECIFIER
QUANTITY
DATE

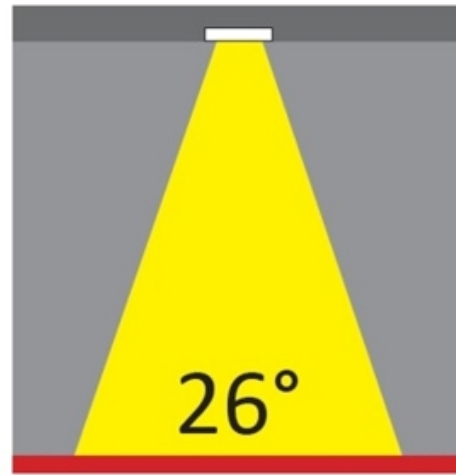
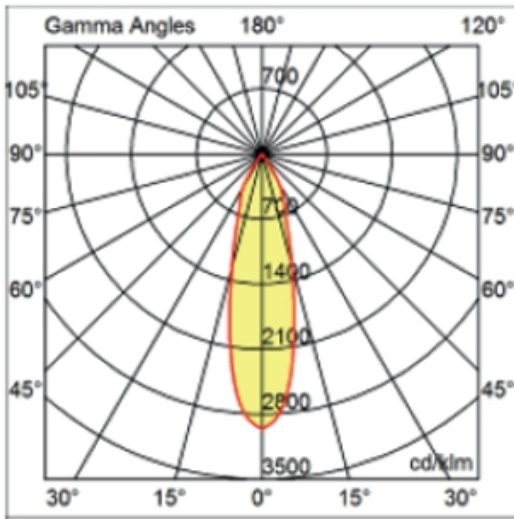

	DP	DV		Order Example	K°
Dimming	Phase	0-10V		L5XXXXXX-DV-30K	
Color Temperature	27K	30K	35K	0-10V	3000K
	2700K	3000K	3500K		

A

PROJECT	_____
TYPE	_____
SPECIFIER	_____
QUANTITY	_____
DATE	_____

DIXIT RA8 RECESSED

A56069-

base number _____
 Color _____
 Temperature _____

- To build a product code in our configurator select the specify button on the base model # product page
- To build a manual product code on this datasheet choose from the options listed below in blue font and add the suffix to the base model #

GENERAL

Series: Dixit
 Subseries: Dixit RA8
 Brand: Ivela
 Division: Architectural
 Mounting Type: Recessed
 Mounting Location: Ceiling
 Subcategory: Downlight

PHYSICAL

Shape: Round
 Diameter (mm): 80
 Diameter (in): 3 1/8
 Height (mm): 74
 Height (in): 2 15/16
 Min. Recessing Depth (mm): 114
 Min. Recessing Depth (in): 4 1/2
 Light Distribution: Direct
 Weight (kg): 0.4
 Weight (lbs): 0.88
 Diffuser: Clear Polycarbonate
 Fixture Finish: MWH
 Fixture Material: Aluminum Die Cast
 Cut-out Measurements: 70mm / 2 3/4"

ELECTRICAL

Lamp Type: LED
 Total Output Wattage (W): 9 / 12
 Dimming: Tri-Mode (Non-Dimming and Phase Dimming (120Vac only) and 0-10V Dimming)
 Driver Included: No
 Driver Location: Recessed Housing
 Driver Type: Constant Current - Universal
 Driver Class: Class 2
 Input Voltage (V): 120 - 277
 Constant Current (MA): 250 / 350

LED

Number of LEDs: 1
 Color Temperature (°K): 2700 / 3000
 Max. Delivered Lumen (lm): 1096 / 1447
 CRI: >80 CRI
 Efficiency (%): 88
 Lamp Life (hrs): 50000
 Upon Request: 3500K upon request

OPTICAL

Optic°: 26
 Adjustability: Fixed
 Upon Request: Optic 45° (mirror-metallized) / 65° (white)

RATINGS AND CERTIFICATIONS

Certified By: Certified for North American Standards
 IP rating: IP44
 IK Rating: IK08
 Glare Rating: ≤ 19

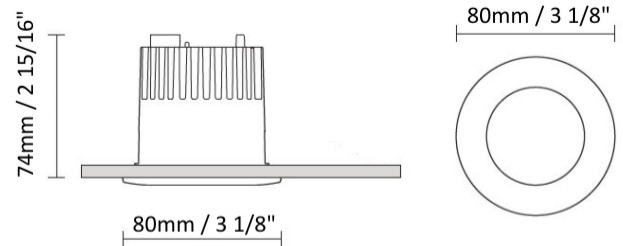

Ø 70mm (2 3/4")

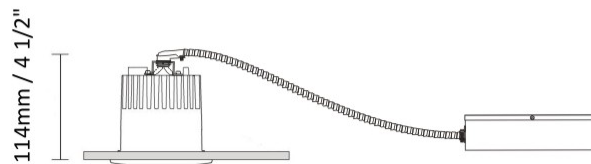



DIXIT RA8 RECESSED

A56069-

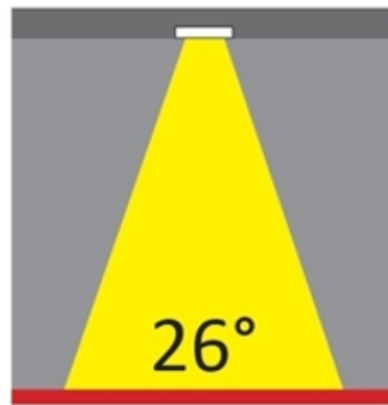
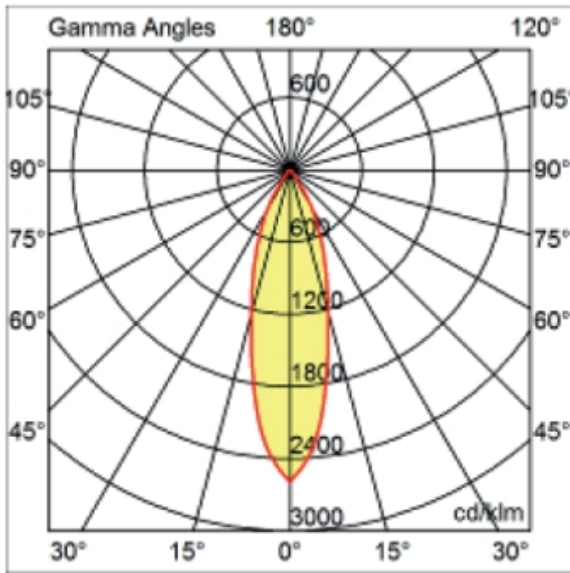
PROJECT	
TYPE	
SPECIFIER	
QUANTITY	
DATE	



	DP	DV	
Dimming	Phase	0-10V	
Color Temperature	27K 2700K	30K 3000K	35K 3500K 40K 4000K
			K°

Order Example  **K°**
L5XXXXXX-DV-30K
 0-10V 3000K



DIXIT RA8 RECESSED

A56073-

base number _____ Color _____
Temperature _____

PROJECT	_____
TYPE	_____
SPECIFIER	_____
QUANTITY	_____
DATE	_____

- To build a product code in our configurator select the specify button on the base model # product page
- To build a manual product code on this datasheet choose from the options listed below in blue font and add the suffix to the base model #

GENERAL

Series: Dixit
Subseries: Dixit RA8
Brand: Ivela
Division: Architectural
Mounting Type: Recessed
Mounting Location: Ceiling
Subcategory: Downlight

PHYSICAL

Shape: Round
Diameter (mm): 95
Diameter (in): 3 3/4
Height (mm): 82
Height (in): 3 1/4
Min. Recessing Depth (mm): 122
Min. Recessing Depth (in): 4 13/16
Light Distribution: Adjustable / Direct
Weight (kg): 0.4
Weight (lbs): 0.88
Diffuser: Clear Polycarbonate
Fixture Finish: MWH
Fixture Material: Aluminum Die Cast
Cut-out Measurements: 86mm / 3 3/8"

ELECTRICAL

Lamp Type: LED
Total Output Wattage (W): 9 / 12
Dimming: Tri-Mode (Non-Dimming and Phase Dimming (120Vac only) and 0-10V Dimming)
Driver Included: No
Driver Location: Recessed Housing
Driver Type: Constant Current - Universal
Driver Class: Class 2
Input Voltage (V): 120 - 277
Constant Current (MA): 250 / 350

LED

Number of LEDs: 1
Color Temperature (°K): 2700 / 3000 / 4000
Max. Delivered Lumen (lm): 1096 / 1447
CRI: >80 CRI
Efficiency (%): 87.7
Lamp Life (hrs): 50000
Upon Request: 3500K upon request

OPTICAL

Optic°: 26
Beam Angle: Symmetric
Adjustability: Tilt ±20°
Upon Request: Optic 45° (mirror-metallized) / 65° (white)

RATINGS AND CERTIFICATIONS

Certified By: Certified for North American Standards
IP rating: IP20
IK Rating: IK08
Glare Rating: ≤ 19

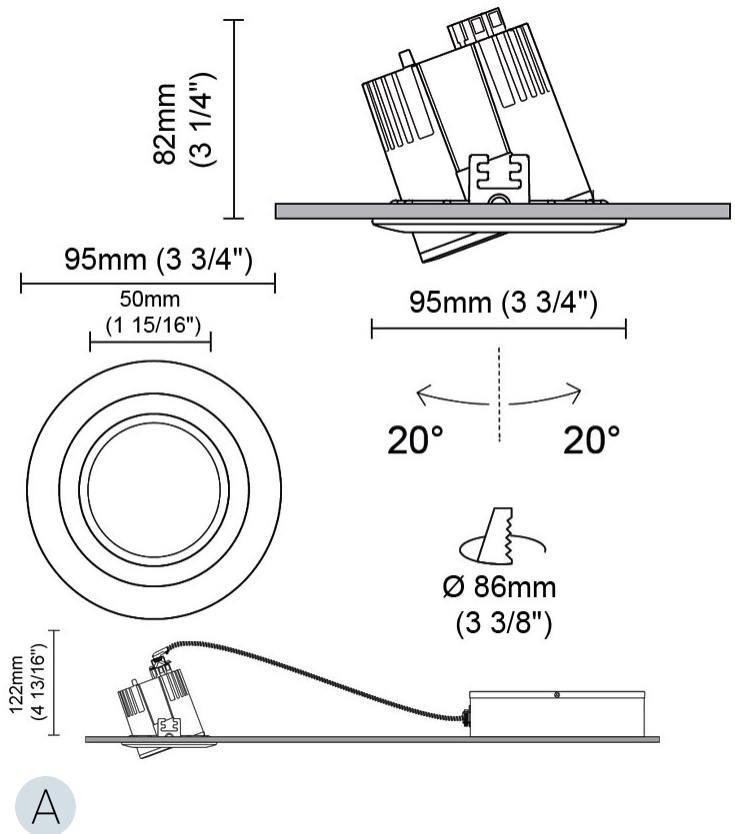

DIXIT RA8 RECESSED

A56073-

PROJECT
TYPE
SPECIFIER
QUANTITY
DATE

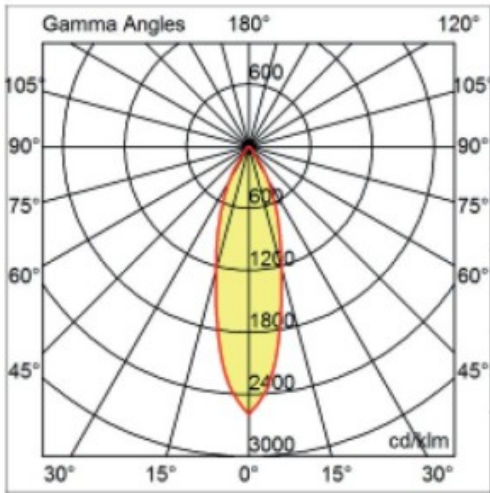

26°

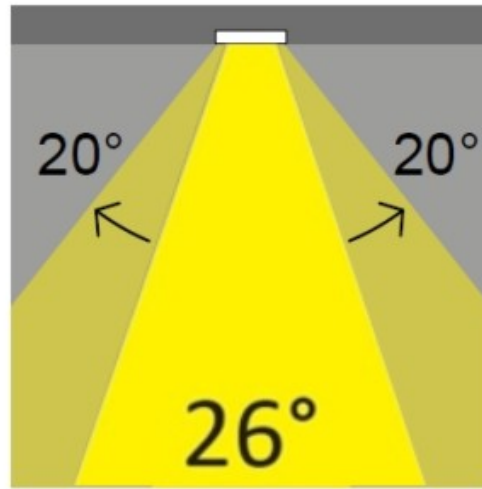

	DP	DV			
Dimming	Phase	0-10V			
Color Temperature	27K	30K	35K	40K	K°
	2700K	3000K	3500K	4000K	

Order Example **K°**
L5XXXXXX-DV-30K
 0-10V 3000K



DIXIT RA14 RECESSED

A56093-

base number _____ Color _____
 Temperature _____

- To build a product code in our configurator select the specify button on the base model # product page
- To build a manual product code on this datasheet choose from the options listed below in blue font and add the suffix to the base model #

GENERAL

Series: Dixit
 Subseries: Dixit RA14
 Brand: Ivela
 Division: Architectural
 Mounting Type: Recessed
 Mounting Location: Ceiling
 Subcategory: Downlight

PHYSICAL

Shape: Round
 Diameter (mm): 140
 Diameter (in): 5 1/2
 Height (mm): 92
 Height (in): 3 5/8
 Min. Recessing Depth (mm): 132
 Min. Recessing Depth (in): 5 3/16
 Light Distribution: Direct
 Weight (kg): 0.7
 Weight (lbs): 1.54
 Diffuser: Clear Polycarbonate
 Fixture Finish: MWH
 Fixture Material: Aluminum Die Cast
 Cut-out Measurements: 126mm / 4 15/16"

ELECTRICAL

Lamp Type: LED
 Total Output Wattage (W): 26 / 33 / 38
 Dimming: Tri-Mode (Non-Dimming and Phase Dimming (120Vac only) and 0-10V Dimming)
 Driver Included: No
 Driver Location: Recessed Housing
 Driver Type: Constant Current - Universal
 Driver Class: Class 2
 Input Voltage (V): 120 - 277
 Constant Current (MA): 700 / 900 / 1050

LED

Number of LEDs: 1
 Color Temperature (°K): 2700 / 3000 / 4000
 Max. Delivered Lumen (lm): 2924 - 3100 / 3655 - 3748 / 4214 - 4300
 CRI: >85 CRI
 Efficiency (%): 86
 Lamp Life (hrs): 50000
 Upon Request: 3500K

OPTICAL

Optic°: 60
 Beam Angle: Symmetric
 Adjustability: Fixed

RATINGS AND CERTIFICATIONS

Certified By: CSA Certified to UL and CSA Standards
 IP Rating: IP44
 IK Rating: IK08

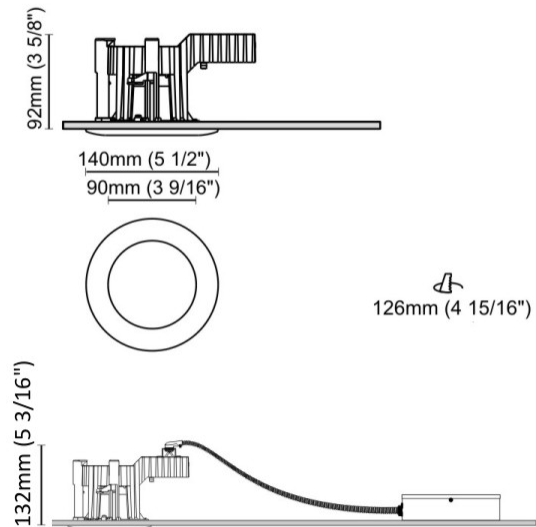

DIXIT RA14 RECESSED

A56093-

PROJECT	
TYPE	
SPECIFIER	
QUANTITY	
DATE	

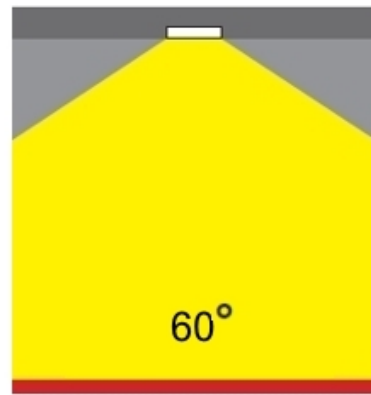
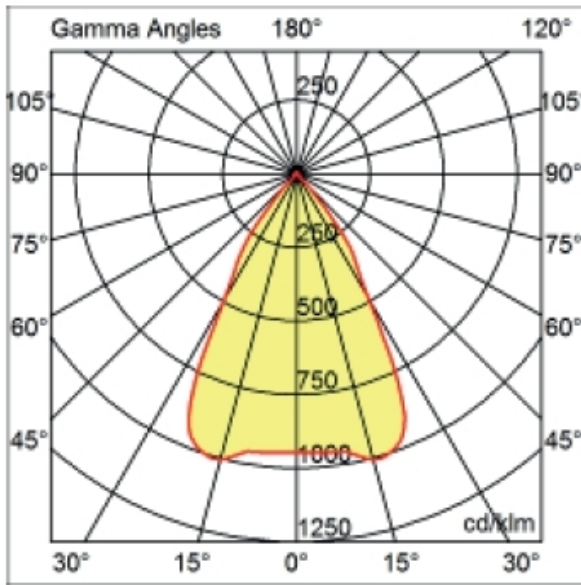

Matte White



Silver

	DP	DV	
Dimming	Phase	0-10V	
Color Temperature	27K 2700K	30K 3000K	35K 3500K 40K 4000K

Order Example  **K°**
L5XXXXXX-DV-30K
 0-10V 3000K



PROJECT	
TYPE	
SPECIFIER	
QUANTITY	
DATE	

DIXIT RA8 RECESSED

A56121-

base number Color
Temperature

- To build a product code in our configurator select the specify button on the base model # product page
- To build a manual product code on this datasheet choose from the options listed below in blue font and add the suffix to the base model #

GENERAL

Series: Dixit
Subseries: Dixit RA8
Brand: Ivela
Division: Architectural
Mounting Type: Recessed
Mounting Location: Ceiling
Subcategory: Downlight

PHYSICAL

Shape: Round
Diameter (mm): 80
Diameter (in): 3 1/8
Height (mm): 50
Height (in): 1 15/16
Min. Recessing Depth (mm): 90
Min. Recessing Depth (in): 3 9/16
Light Distribution: Direct
Weight (kg): 0.4
Weight (lbs): 0.88
Diffuser: Clear Polycarbonate
Fixture Finish: MWH
Fixture Material: Aluminum Die Cast
Cut-out Measurements: 70mm / 2 3/4"

ELECTRICAL

Lamp Type: LED
Total Output Wattage (W): 5.5 / 8.5
Dimming: Tri-Mode (Non-Dimming and Phase Dimming (120Vac only) and 0-10V Dimming)
Driver Included: No
Driver Location: Recessed Housing
Driver Type: Constant Current - Universal
Driver Class: Class 2
Input Voltage (V): 120 - 277
Constant Current (mA): 350 / 500

LED

Number of LEDs: 1
Color Temperature (°K): 2700 / 3000 / 3500 / 4000
Max. Delivered Lumen (lm): 501 / 638
CRI: >90 CRI
Efficiency (%): 91
Lamp Life (hrs): 50000

OPTICAL

Reflector: Mirror-metallized thermoplastic material
Optic: 26
Beam Angle: Symmetric
Adjustability: Fixed
Upon Request: Optic 45° (mirror-metallized) / 65° (white)

RATINGS AND CERTIFICATIONS

Certified By: CSA Certified to UL and CSA Standards
IP rating: IP44
IK Rating: IK08

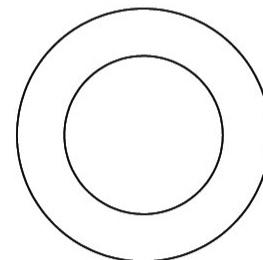
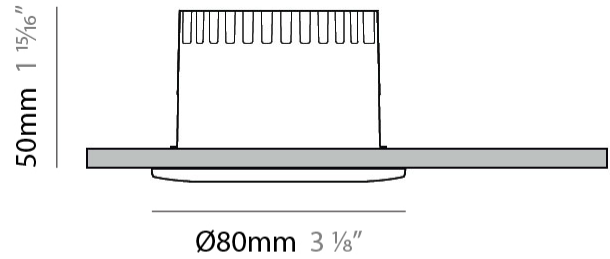



DIXIT RA8 RECESSED

A56121-

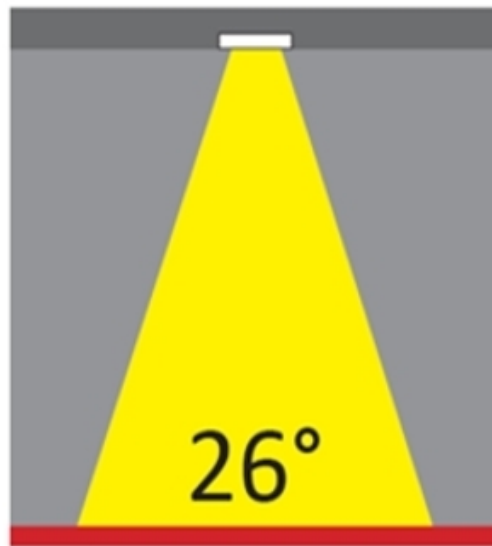
PROJECT
TYPE
SPECIFIER
QUANTITY
DATE



	DP	DV		Order Example		K°
Dimming	Phase	0-10V		L5XXXXXX-DV-30K		
Color Temperature	27K	30K	35K	40K		K°
	2700K	3000K	3500K	4000K	0-10V	3000K



PROJECT

TYPE

SPECIFIER

QUANTITY

DATE

Fixture Finish

Matte White - MWH



Digital: Not all screens are calibrated the same, and therefore, colors will appear differently between screens.

Physical: When texture is involved, there will be variations in color, character and tone within a product series and between product families.



LEGEND

 floor-mounted	 pivotable	 special LED (upon request) RGB, RGBW, tunable, gold+, meat+, art+, fashion+
 wall and ceiling: recessed and surface mounted	 rotating	 warm dim / natural dimming LED
 ceiling-mounted and wall-mounted	 illuminate tilted	 rechargeable battery powered
 wall-mounted	 color of suspension cable	 fixture with natural vivid LED (upon request)
 omni-directional light distribution	 length of suspension cable	 color rendering index
 direct light distribution	 reflector degree selection	 color temperature
 direct/indirect light distribution	 super spot	 lumen (luminous flux)
 indirect light distribution	 lens	 efficacy (lumens per watt)
 asymmetric light distribution	 lens pack	 Unified Glare Rating (UGR) range from 5-40
 aura light distribution	 shine ring	 marine grade (AISI 316 stainless steel)
 round wall or ceiling cut-out	 integrated shine ring with diffuser	 walk on
 square wall or ceiling cut-out	 free individual colors 01-29	 drive on
 the supplied jig specifies the cutout dimensions	 individual colors: 00 (free of charge), 01-25 (extra charge)	 Dark Sky Compliance
 minimum distance (meters) lamp - object	 luminaire part to be colored (F1)	 Americans with Disabilities Act (less than 4" off the wall located between 27"-84" from floor)
 recessed depth	 luminaire part to be colored (F2)	 lamp protected against explosion
 ceiling thickness in mm	 luminaire part to be colored (F3)	 blown glass using traditional methods by master glass blower
 ceiling thickness selection	 luminaire part to be colored (F4)	 acoustic material
 dimmable DP (phase), DV (0-10V), DD (dali), DS (step-dim)	 luminaire part to be colored (F5)	 protection class I, protection insulation
 included or excluded LED driver/transformer/control gear	 color of 3-circuit adaptor	 protection class II, protection insulation
 separately switchable	 indirect diffuser	 ETL Certified to UL and CSA Standards
 sensor	 direct diffuser	 UL Certified to UL and CSA Standards
 remote control	 ball-proof (upon request)	 CSA Certified to UL and CSA Standards
 available upon request	 accessory	 Certified for North American Standards

IP RATING

 IP20	protected against ingress of solid bodies greater than 12.5mm (finger)
 IP33	protected against ingress of solid bodies greater than 2.5mm protected against sprays of water up to 60 degrees from the vertical (rain)
 IP40	protected against ingress of solid bodies greater than 1mm (wire) no protection against the ingress of moisture
 IP43	protected against ingress of solid bodies greater than 1mm (wire) protected against sprays of water up to 60 degrees from the vertical (rain)
 IP44	protected against ingress of solid bodies greater than 1mm (wire) protected against water splashed from all directions
 IP54	protected against limited ingress of dust (wet rooms/covered outdoor areas) protected against water splashed from all directions
 IP65	protected against ingress of dust protected against jets of water
 IP66	protected against ingress of dust protected against powerful jets of water or heavy seas
 IP67	protected against ingress of dust protected against immersion of water between 15cm - 1m for 30 minutes
 IP68	protected against ingress of dust protected against immersion of water under pressure for long periods

IK RATING

 IK01	protected against 0.14 joules impact (equivalent to 0.25kg mass dropped from 56mm above the surface)
 IK02	protected against 0.2 joules impact (equivalent to 0.25kg mass dropped from 80mm above the surface)
 IK03	protected against 0.35 joules impact (equivalent to 0.25kg mass dropped from 140mm above the surface)
 IK04	protected against 0.5 joules impact (equivalent to 0.25kg mass dropped from 200mm above the surface)
 IK05	protected against 0.7 joules impact (equivalent to 0.25kg mass dropped from 280mm above the surface)
 IK06	protected against 1 joules impact (equivalent to 0.25kg mass dropped from 400mm above the surface)
 IK07	protected against 2 joules impact (equivalent to 0.5kg mass dropped from 400mm above the surface)
 IK08	protected against 5 joules impact (equivalent to 1.7kg mass dropped from 300mm above the surface)
 IK09	protected against 10 joules impact (equivalent to 5.0kg mass dropped from 200mm above the surface)
 IK10	protected against 20 joules impact (equivalent to 5.0kg mass dropped from 400mm above the surface)