

## DIXIT RECESSED

### A5601121-

base number Color  
Temperature

1. To build a product code in our configurator select the specify button on the base model # product page
2. To build a manual product code on this datasheet choose from the options listed below in blue font and add the suffix to the base model #

#### GENERAL

Series: Dixit  
Brand: Ivela  
Division: Architectural  
Mounting Type: Recessed  
Mounting Location: Ceiling  
Subcategory: Downlight

#### PHYSICAL

Shape: Round  
Diameter (mm): 95  
Diameter (in): 3 <sup>3</sup>/<sub>4</sub>  
Depth (mm): 82  
Depth (in): 3 <sup>1</sup>/<sub>4</sub>  
Min. Recessing Depth (mm): 122  
Min. Recessing Depth (in): 4 <sup>13</sup>/<sub>16</sub>  
Light Distribution: Adjustable / Direct  
Weight (kg): 0.4  
Weight (lbs): 0.88  
Cut-out Measurements: 86mm / 3 3/8

#### ELECTRICAL

Lamp Type: LED  
Total Output Wattage (W): 12  
Dimming: Tri-Mode (Non-Dimming and Phase Dimming (120Vac only) and 0-10V Dimming)  
Driver Included: No  
Driver Location: Recessed Housing  
Driver Type: Constant Current - Universal  
Driver Class: Class 2  
Input Voltage (V): 120 - 277  
Constant Current (MA): 350

#### LED

Number of LEDs: 1  
Color Temperature (°K): 2700 / 3000 / 4000  
Max. Delivered Lumen (lm): 1447  
CRI: >80 CRI  
Efficiency (%): 91  
Lamp Life (hrs): 50000

#### OPTICAL

Optic°: 26  
Adjustability: Tilt 20°  
Upon Request: Optic 45° (mirror-metallized) / 65° (white)

#### RATINGS AND CERTIFICATIONS

Certified By: CSA Certified to UL and CSA Standards  
IP rating: IP20  
IK Rating: IK08  
Glare Rating: ≤ 19



## DIXIT RA20 RECESSED

### A56015-

base number \_\_\_\_\_  
Color \_\_\_\_\_  
Temperature \_\_\_\_\_

1. To build a product code in our configurator select the specify button on the base model # product page
2. To build a manual product code on this datasheet choose from the options listed below in blue font and add the suffix to the base model #

#### GENERAL

Series: Dixit  
Subseries: Dixit RA20  
Brand: Ivela  
Division: Architectural  
Mounting Type: Recessed  
Mounting Location: Ceiling  
Subcategory: Downlight

#### PHYSICAL

Shape: Round  
Diameter (mm): 200  
Diameter (in): 7 7/8  
Height (mm): 95  
Height (in): 3 3/4  
Min. Recessing Depth (mm): 143  
Min. Recessing Depth (in): 5 5/8  
Light Distribution: Direct  
Weight (kg): 1.8  
Weight (lbs): 3.97  
Diffuser: Clear Polycarbonate  
Fixture Finish: MWH  
Fixture Material: Aluminum Die Cast  
Cut-out Measurements: 185mm / 7 9/32"

#### ELECTRICAL

Lamp Type: LED  
Total Output Wattage (W): 51  
Dimming: Tri-Mode (Non-Dimming and Phase Dimming (120Vac only) and 0-10V Dimming)  
Driver Included: No  
Driver Location: Recessed Housing  
Driver Type: Constant Current - Universal  
Driver Class: Class 2  
Housing: See Components  
Input Voltage (V): 120 - 277  
Constant Current (MA): 1400

#### LED

Number of LEDs: 1  
Color Temperature (°K): 2700 / 3000 / 4000  
Max. Delivered Lumen (lm): 5375 / 5485 / 5656  
CRI: >85 CRI  
Efficiency (%): 85.7  
Lamp Life (hrs): 50000  
Upon Request: 3500K upon request

#### OPTICAL

Optic°: 100

#### RATINGS AND CERTIFICATIONS

Certified By: CSA Certified to UL and CSA Standards  
IP rating: IP44  
IK Rating: IK07



## DIXIT RA20 RECESSED

A56015-

|           |  |
|-----------|--|
| PROJECT   |  |
| TYPE      |  |
| SPECIFIER |  |
| QUANTITY  |  |
| DATE      |  |

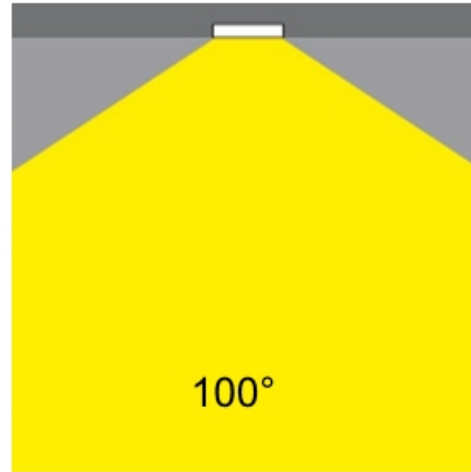
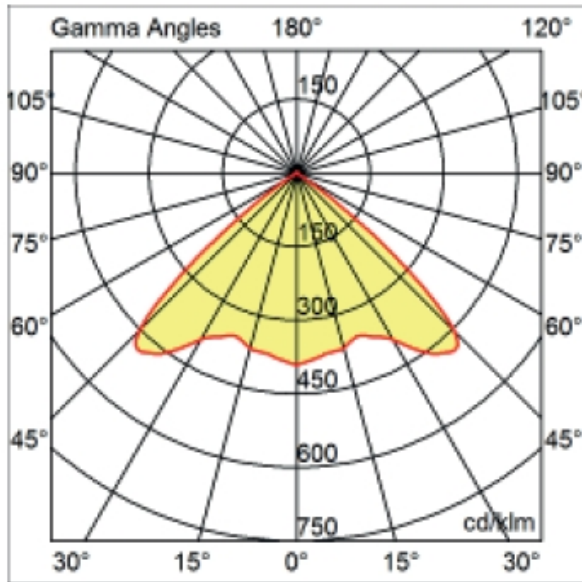

|                   |       |       |       |       |
|-------------------|-------|-------|-------|-------|
|                   | DP    | DV    |       |       |
| Dimming           | Phase | 0-10V |       |       |
| Color Temperature | 27K   | 30K   | 35K   | 40K   |
|                   | 2700K | 3000K | 3500K | 4000K |

Order Example  **K°**  
**L5XXXXXX-DV-30K**  
 0-10V  
 3000K



## DIXIT RA17 RECESSED

### A56019-30K

base number

- To build a product code in our configurator select the specify button on the base model # product page
- To build a manual product code on this datasheet choose from the options listed below in blue font and add the suffix to the base model #

#### GENERAL

Series: Dixit  
 Subseries: Dixit RA17  
 Brand: Ivela  
 Division: Architectural  
 Mounting Type: Recessed  
 Mounting Location: Ceiling  
 Subcategory: Downlight

#### PHYSICAL

Shape: Round  
 Diameter (mm): 168  
 Diameter (in): 6 5/8  
 Height (mm): 180  
 Height (in): 7 1/16  
 Min. Recessing Depth (mm): 180  
 Min. Recessing Depth (in): 7 1/16  
 Light Distribution: Adjustable / Direct  
 Weight (kg): 2  
 Weight (lbs): 4.40  
 Diffuser: Clear Polycarbonate  
 Fixture Finish: MWH  
 Fixture Material: Aluminum Die Cast

#### ELECTRICAL

Lamp Type: LED  
 Total Output Wattage (W): 33  
 Dimming: Tri-Mode (Non-Dimming and Phase Dimming (120Vac only) and 0-10V Dimming)  
 Driver Included: No  
 Driver Location: Recessed Housing  
 Driver Type: Constant Current - Universal  
 Driver Class: Class 2  
 Housing: See Components  
 Input Voltage (V): 120 - 277  
 Constant Current (MA): 900

#### LED

Number of LEDs: 1  
 Color Temperature (°K): 3000  
 Max. Delivered Lumen (lm): 3770  
 CRI: >85 CRI  
 Lamp Life (hrs): 50000

#### OPTICAL

Optic°: 30  
 Upon Request: Optic 17° or 55° (mirror-metallized) / 70° (white)

#### RATINGS AND CERTIFICATIONS

Certified By: Certified for North American Standards  
 IP rating: IP20  
 IK Rating: IK07

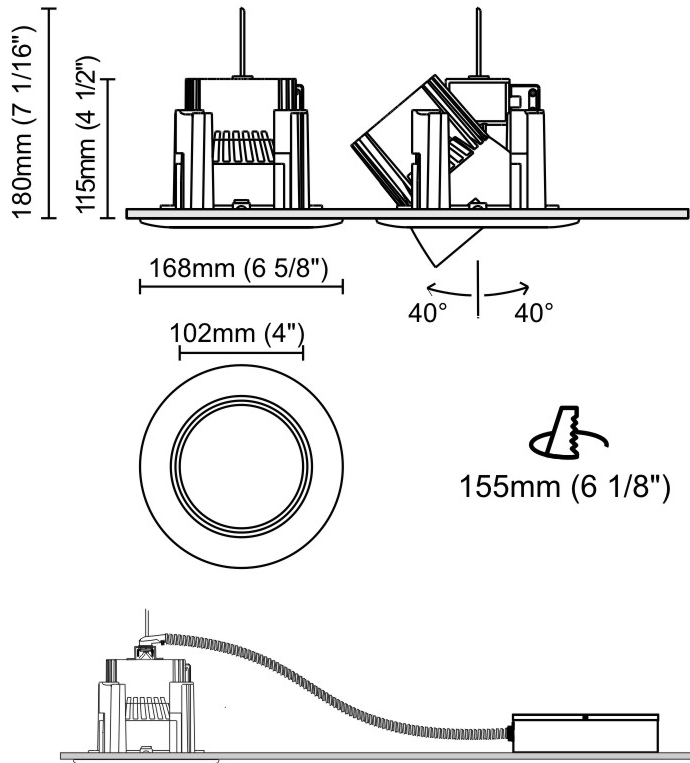

|           |       |
|-----------|-------|
| PROJECT   | _____ |
| TYPE      | _____ |
| SPECIFIER | _____ |
| QUANTITY  | _____ |
| DATE      | _____ |

## DIXIT RA11 RECESSED

### A56020-

base number \_\_\_\_\_ Color \_\_\_\_\_  
Temperature \_\_\_\_\_

- To build a product code in our configurator select the specify button on the base model # product page
- To build a manual product code on this datasheet choose from the options listed below in blue font and add the suffix to the base model #

#### GENERAL

Series: Dixit  
Subseries: Dixit RA11  
Brand: Ivela  
Division: Architectural  
Mounting Type: Recessed  
Mounting Location: Ceiling  
Subcategory: Downlight

#### PHYSICAL

Shape: Round  
Diameter (mm): 110  
Diameter (in): 4 <sup>5</sup>/<sub>16</sub>  
Height (mm): 70  
Height (in): 2 <sup>7</sup>/<sub>16</sub>  
Min. Recessing Depth (mm): 110  
Min. Recessing Depth (in): 4 <sup>15</sup>/<sub>16</sub>  
Light Distribution: Direct  
Weight (kg): 0.6  
Weight (lbs): 1.32  
Diffuser: Clear Polycarbonate  
Fixture Finish: MWH  
Fixture Material: Aluminum Die Cast  
Cut-out Measurements: 100mm / 3 15/16"

#### ELECTRICAL

Lamp Type: LED  
Total Output Wattage (W): 12 / 18 / 26  
Dimming: Tri-Mode (Non-Dimming and Phase Dimming (120Vac only) and 0-10V Dimming)  
Driver Included: No  
Driver Location: Recessed Housing  
Driver Type: Constant Current - Universal  
Driver Class: Class 2  
Input Voltage (V): 120 - 277  
Constant Current (MA): 350 / 500 / 700

#### LED

Number of LEDs: 1  
Color Temperature (°K): 2700 / 3000 / 4000  
Max. Delivered Lumen (lm): 1513 / 2092 / 2759  
CRI: >85 CRI  
Efficiency (%): 89  
Lamp Life (hrs): 50000  
Upon Request: 3500K upon request

#### OPTICAL

Optic°: 55  
Adjustability: Fixed  
Upon Request: Optic 18° or 30° (mirror-metallized) / 70° (white)

#### RATINGS AND CERTIFICATIONS

Certified By: Certified for North American Standards  
IP rating: IP43  
IK Rating: IK08  
Glare Rating: ≤ 19

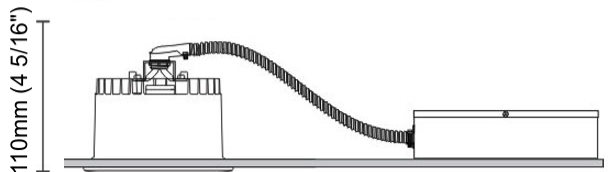
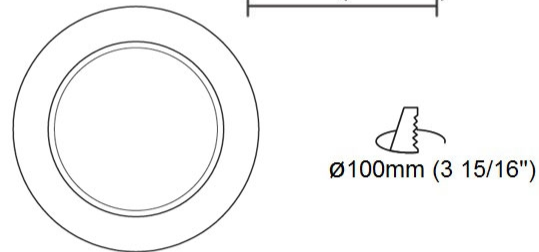
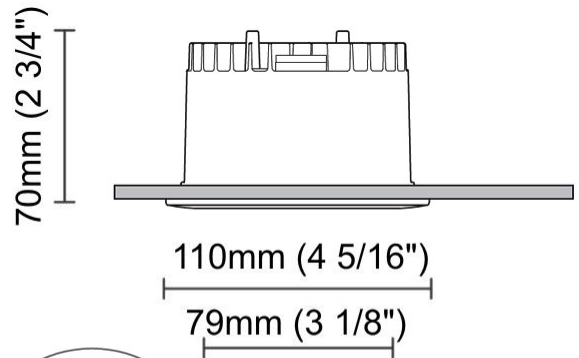

## DIXIT RA11 RECESSED

A56020-

|           |  |
|-----------|--|
| PROJECT   |  |
| TYPE      |  |
| SPECIFIER |  |
| QUANTITY  |  |
| DATE      |  |

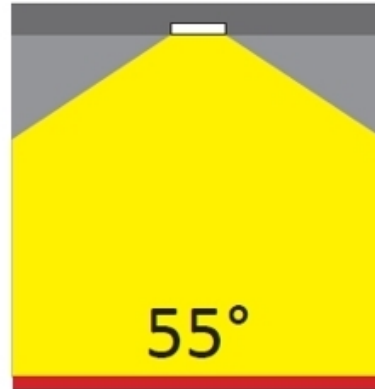
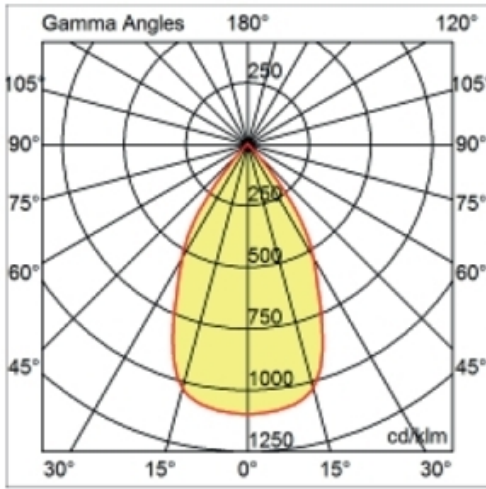

| RA 11 DIXIT LED 12W 1700LM 3000K |      |         |         | R:100%    |      |      |         | I.Max:1096 Cd/Klm |          |  |  |
|----------------------------------|------|---------|---------|-----------|------|------|---------|-------------------|----------|--|--|
| H[m]                             | D[m] | Max lux | Med lux | Alpha=55° | H[m] | D[m] | Max lux | Med lux           | Beta=55° |  |  |
| 1.00                             | 1.13 | 1658    | 898     |           | 1.00 | 1.13 | 1658    | 898               |          |  |  |
| 2.00                             | 2.26 | 415     | 224     |           | 2.00 | 2.26 | 415     | 224               |          |  |  |
| 3.00                             | 3.38 | 184     | 100     |           | 3.00 | 3.38 | 184     | 100               |          |  |  |
| 4.00                             | 4.51 | 104     | 56      |           | 4.00 | 4.51 | 104     | 56                |          |  |  |
| 5.00                             | 5.64 | 66      | 36      |           | 5.00 | 5.64 | 66      | 36                |          |  |  |

|                   |                 |                         |    |
|-------------------|-----------------|-------------------------|----|
|                   | DP              | DV                      |    |
| Dimming           | Phase           | 0-10V                   |    |
| Color Temperature | 27K 30K 35K 40K | 2700K 3000K 3500K 4000K | K° |

Order Example **L5XXXXXX-DV-30K**

0-10V 3000K



## DIXIT RA11 RECESSED

### A56024-

base number            Color             
Temperature           

- To build a product code in our configurator select the specify button on the base model # product page
- To build a manual product code on this datasheet choose from the options listed below in blue font and add the suffix to the base model #

#### GENERAL

Series: Dixit  
Subseries: Dixit RA11  
Brand: Ivela  
Division: Architectural  
Mounting Type: Recessed  
Mounting Location: Ceiling  
Subcategory: Downlight

#### PHYSICAL

Shape: Round  
Diameter (mm): 125  
Diameter (in): 4 <sup>15</sup>/<sub>16</sub>  
Height (mm): 79  
Height (in): 3 <sup>1</sup>/<sub>8</sub>  
Min. Recessing Depth (mm): 119  
Min. Recessing Depth (in): 4 <sup>11</sup>/<sub>16</sub>  
Light Distribution: Direct  
Weight (kg): 0.6  
Weight (lbs): 1.32  
Diffuser: Clear Polycarbonate  
Fixture Finish: MWH  
Fixture Material: Aluminum Die Cast  
Cut-out Measurements: 116mm / 4 9/16"

#### ELECTRICAL

Lamp Type: LED  
Total Output Wattage (W): 12 / 18 / 26  
Dimming: Tri-Mode (Non-Dimming and Phase Dimming (120Vac only) and 0-10V Dimming)  
Driver Included: No  
Driver Location: Recessed Housing  
Driver Type: Constant Current - Universal  
Driver Class: Class 2  
Input Voltage (V): 120 - 277  
Constant Current (MA): 350 / 500 / 700

#### LED

Number of LEDs: 1  
Color Temperature (°K): 2700 / 3000 / 4000  
Max. Delivered Lumen (lm): 1513 - 1602 / 2092 - 2180 / 2759 - 2848  
CRI: >85 CRI  
Efficiency (%): 89  
Lamp Life (hrs): 50000  
Upon Request: 3500K upon request

#### OPTICAL

Optic°: 55  
Adjustability: Tilt ±20°  
Upon Request: Optic 18° or 30° (mirror-metallized) / 70° (white)

#### RATINGS AND CERTIFICATIONS

Certified By: Certified for North American Standards  
IP rating: IP20  
IK Rating: IK08  
Glare Rating: ≤ 19

|           |       |
|-----------|-------|
| PROJECT   | _____ |
| TYPE      | _____ |
| SPECIFIER | _____ |
| QUANTITY  | _____ |
| DATE      | _____ |

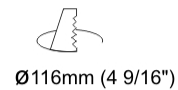
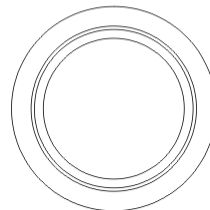
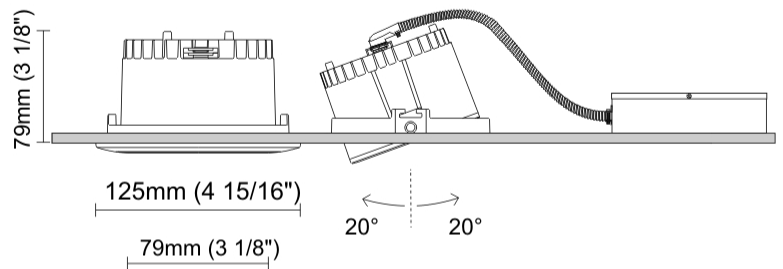



## DIXIT RA11 RECESSED

A56024-

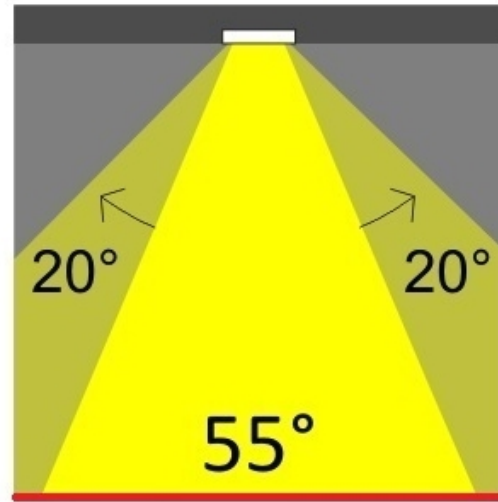
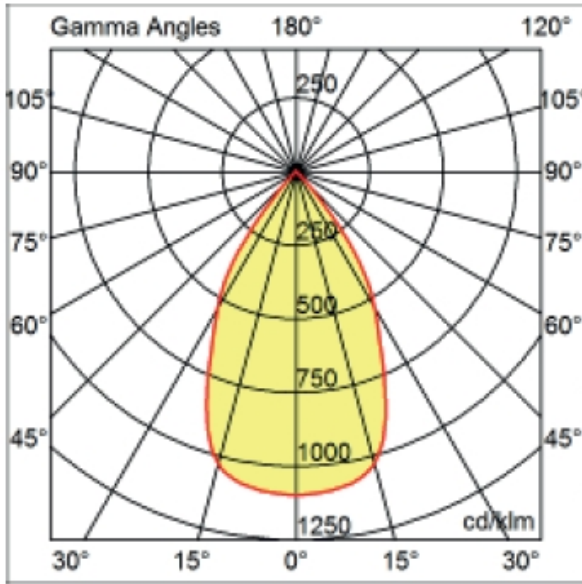
|           |  |
|-----------|--|
| PROJECT   |  |
| TYPE      |  |
| SPECIFIER |  |
| QUANTITY  |  |
| DATE      |  |



|                   |              |              |   |
|-------------------|--------------|--------------|---|
|                   | DP           | DV           |   |
| Dimming           | Phase        | 0-10V        |  |
| Color Temperature | 27K<br>2700K | 30K<br>3000K | 35K<br>3500K  |
|                   |              | 40K<br>4000K | <b>K°</b>   |

Order Example  **K°**  
**L5XXXXXX-DV-30K**  
 0-10V  
 3000K

A



## DIXIT RA11 RECESSED

### A56028-

base number            Color             
Temperature           

|           |       |
|-----------|-------|
| PROJECT   | _____ |
| TYPE      | _____ |
| SPECIFIER | _____ |
| QUANTITY  | _____ |
| DATE      | _____ |

- To build a product code in our configurator select the specify button on the base model # product page
- To build a manual product code on this datasheet choose from the options listed below in blue font and add the suffix to the base model #

#### GENERAL

Series: Dixit  
Subseries: Dixit RA11  
Brand: Ivela  
Division: Architectural  
Mounting Type: Recessed  
Mounting Location: Ceiling  
Subcategory: Downlight

#### PHYSICAL

Shape: Round  
Diameter (mm): 126  
Diameter (in): 4 15/16  
Height (mm): 104  
Height (in): 4 1/8  
Min. Recessing Depth (mm): 144  
Min. Recessing Depth (in): 5 11/16  
Light Distribution: Direct  
Weight (kg): 0.6  
Weight (lbs): 1.32  
Diffuser: Clear Polycarbonate  
Fixture Finish: MWH  
Fixture Material: Aluminum Die Cast  
Cut-out Measurements: 122mm / 4 13/16"

#### ELECTRICAL

Lamp Type: LED  
Total Output Wattage (W): 12 / 18 / 26  
Dimming: Tri-Mode (Non-Dimming and Phase Dimming (120Vac only) and 0-10V Dimming)  
Driver Included: No  
Driver Location: Recessed Housing  
Driver Type: Constant Current - Universal  
Driver Class: Class 2  
Input Voltage (V): 120 - 277  
Constant Current (MA): 350 / 500 / 700

#### LED

Number of LEDs: 1  
Color Temperature (°K): 2700 / 3000 / 4000  
Max. Delivered Lumen (lm): 1513 - 1602 / 2092 - 2180 / 2759 - 2848  
CRI: >85 CRI  
Efficiency (%): 89  
Lamp Life (hrs): 50000  
Upon Request: 3500K upon request

#### OPTICAL

Optic°: 55  
Adjustability: Fixed  
Upon Request: Optic 18° or 30° (mirror-metallized) / 70° (white)

#### RATINGS AND CERTIFICATIONS

Certified By: Certified for North American Standards  
IP rating: IP43  
IK Rating: IK08  
Glare Rating: ≤ 19

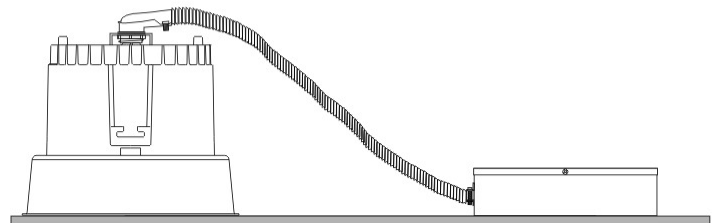
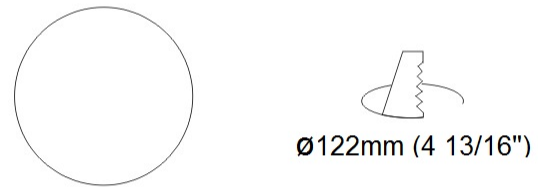
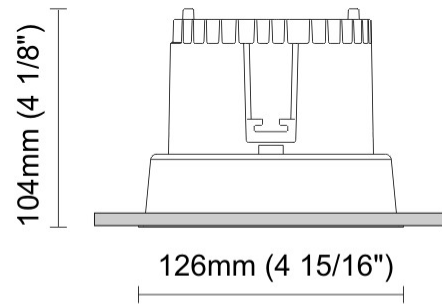

## DIXIT RA11 RECESSED

A56028-

|           |  |
|-----------|--|
| PROJECT   |  |
| TYPE      |  |
| SPECIFIER |  |
| QUANTITY  |  |
| DATE      |  |

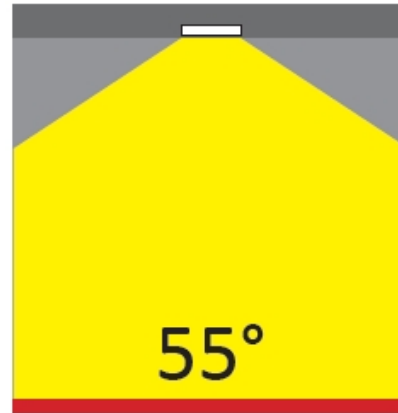
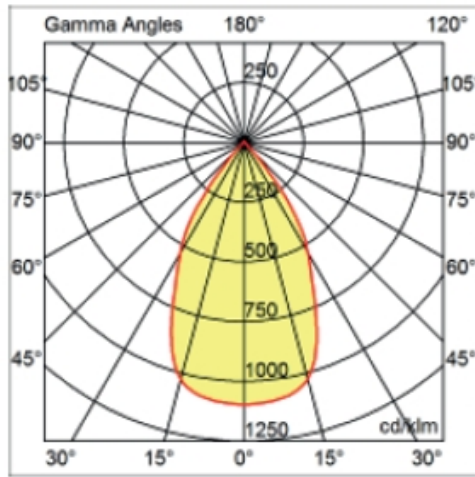

|                   |              |              |              |                        |       |
|-------------------|--------------|--------------|--------------|------------------------|-------|
|                   | DP           | DV           |              | Order Example          | K°    |
| Dimming           | Phase        | 0-10V        |              | <b>L5XXXXXX-DV-30K</b> |       |
| Color Temperature | 27K<br>2700K | 30K<br>3000K | 35K<br>3500K | 0-10V                  | 3000K |

A

|           |       |
|-----------|-------|
| PROJECT   | _____ |
| TYPE      | _____ |
| SPECIFIER | _____ |
| QUANTITY  | _____ |
| DATE      | _____ |

## DIXIT RA11 RECESSED

### A56032-

base number \_\_\_\_\_ Color \_\_\_\_\_  
Temperature \_\_\_\_\_

- To build a product code in our configurator select the specify button on the base model # product page
- To build a manual product code on this datasheet choose from the options listed below in blue font and add the suffix to the base model #

#### GENERAL

Series: Dixit  
Subseries: Dixit RA11  
Brand: Ivela  
Division: Architectural  
Mounting Type: Recessed  
Mounting Location: Ceiling  
Subcategory: Downlight

#### PHYSICAL

Shape: Round  
Diameter (mm): 141  
Diameter (in): 5 5/16  
Height (mm): 117  
Height (in): 4 5/8  
Min. Recessing Depth (mm): 157  
Min. Recessing Depth (in): 6 3/16  
Light Distribution: Direct  
Weight (kg): 0.7  
Weight (lbs): 1.54  
Diffuser: Clear Polycarbonate  
Fixture Finish: MWH  
Fixture Material: Aluminum Die Cast  
Cut-out Measurements: 126mm / 4 15/16"

#### ELECTRICAL

Lamp Type: LED  
Total Output Wattage (W): 12 / 18 / 26  
Dimming: Tri-Mode (Non-Dimming and Phase Dimming (120Vac only) and 0-10V Dimming)  
Driver Included: No  
Driver Location: Recessed Housing  
Driver Type: Constant Current - Universal  
Driver Class: Class 2  
Input Voltage (V): 120 - 277  
Constant Current (MA): 350 / 500 / 700

#### LED

Number of LEDs: 1  
Color Temperature (°K): 2700 / 3000  
Max. Delivered Lumen (lm): 1513 / 2092  
CRI: >85 CRI  
Efficiency (%): 89  
Lamp Life (hrs): 50000  
Upon Request: 3500K upon request

#### OPTICAL

Optic°: 55  
Adjustability: Fixed  
Upon Request: Optic 12° or 30° (mirror-metallized) / 70° (white)

#### RATINGS AND CERTIFICATIONS

Certified By: CSA Certified to UL and CSA Standards  
IP Rating: IP43  
IK Rating: IK08  
Glare Rating: ≤ 19

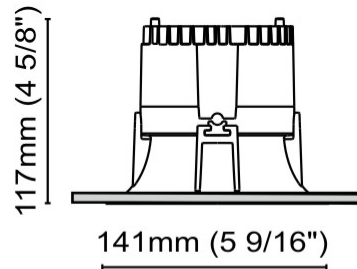

141mm (5 9/16")

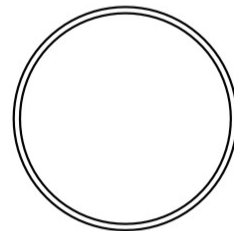

  
126mm (4 15/16")

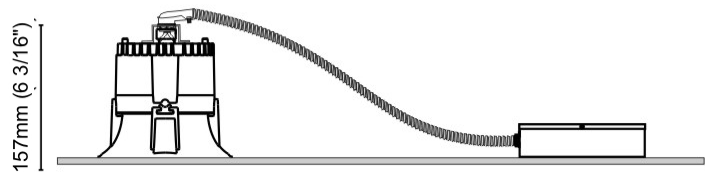

A

|           |  |
|-----------|--|
| PROJECT   |  |
| TYPE      |  |
| SPECIFIER |  |
| QUANTITY  |  |
| DATE      |  |

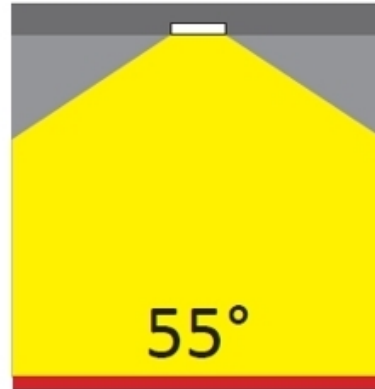

| RA 11 DIXIT LED SOFT 12W 1700 lm 3000K |      |         |         |           | R:100% |      | I.Max:1293 Cd/Klm |         |          |  |
|--|------|---------|---------|-----------|--------|------|-------------------|---------|----------|--|
| H[m]                                   | D[m] | Max lux | Med lux | Alpha=54° | H[m]   | D[m] | Max lux           | Med lux | Beta=54° |  |
| 1.00                                   | 1.02 | 1913    | 1003    |           | 1.00   | 1.02 | 1913              | 1003    |          |  |
| 2.00                                   | 2.04 | 478     | 251     |           | 2.00   | 2.04 | 478               | 251     |          |  |
| 3.00                                   | 3.06 | 213     | 111     |           | 3.00   | 3.06 | 213               | 111     |          |  |
| 4.00                                   | 4.08 | 120     | 63      |           | 4.00   | 4.08 | 120               | 63      |          |  |
| 5.00                                   | 5.10 | 77      | 40      |           | 5.00   | 5.10 | 77                | 40      |          |  |

|                   |       |       |       |    |
|-------------------|-------|-------|-------|----|
| Dimming           | DP    | DV    |       |    |
|                   | Phase | 0-10V |       |    |
| Color Temperature | 27K   | 30K   | 35K   | K° |
|                   | 2700K | 3000K | 3500K |    |

Order Example **K°**

**L5XXXXXX-DV-30K**

0-10V      3000K



## DIXIT RA11 RECESSED

**A56051-** \_\_\_\_\_  
base number

|           |       |
|-----------|-------|
| PROJECT   | _____ |
| TYPE      | _____ |
| SPECIFIER | _____ |
| QUANTITY  | _____ |
| DATE      | _____ |

- To build a product code in our configurator select the specify button on the base model # product page
- To build a manual product code on this datasheet choose from the options listed below in blue font and add the suffix to the base model #

### GENERAL

Series: Dixit  
Subseries: Dixit RA11  
Brand: Ivela  
Division: Architectural  
Mounting Type: Recessed  
Mounting Location: Ceiling  
Subcategory: Downlight

### PHYSICAL

Shape: Square  
Length (mm): 117  
Length (in): 4 5/8  
Width (mm): 117  
Width (in): 4 5/8  
Height (mm): 73  
Height (in): 2 7/8  
Min. Recessing Depth (mm): 113  
Min. Recessing Depth (in): 4 1/2  
Light Distribution: Direct  
Weight (kg): 0.7  
Weight (lbs): 1.54  
Diffuser: Clear Polycarbonate  
Fixture Finish: MWH  
Fixture Material: Aluminum Die Cast  
Cut-out Measurements: 100mm / 3 15/16"

### ELECTRICAL

Lamp Type: LED  
Total Output Wattage (W): 12 / 18 / 26  
Dimming: Tri-Mode (Non-Dimming and Phase Dimming (120Vac only) and 0-10V Dimming)  
Driver Included: No  
Driver Location: Recessed Housing  
Driver Type: Constant Current - Universal  
Driver Class: Class 2  
Input Voltage (V): 120 - 277  
Constant Current (MA): 350 / 500 / 700

### LED

Number of LEDs: 1  
Color Temperature (°K): 2700 / 3000 / 4000  
Max. Delivered Lumen (lm): 1513 - 1602 / 2092 - 2180 / 2759 - 2848  
CRI: >85 CRI  
Efficiency (%): 89  
Lamp Life (hrs): 50000  
Upon Request: 3500K upon request

### OPTICAL

Optic°: 55  
Adjustability: Fixed  
Upon Request: Optic 12° or 30° (mirror-metallized) / 70° (white)

### RATINGS AND CERTIFICATIONS

Certified By: Certified for North American Standards  
IP rating: IP43  
IK Rating: IK08  
Glare Rating: ≤ 19

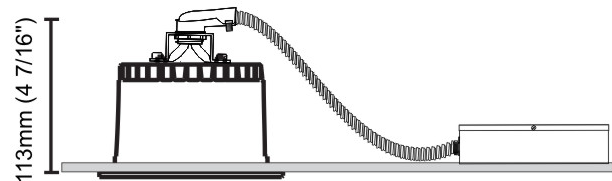
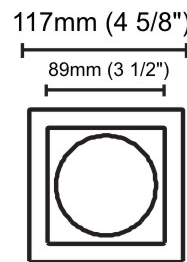
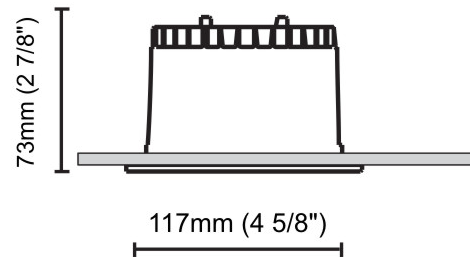

## DIXIT RA11 RECESSED

A56051-

|           |  |
|-----------|--|
| PROJECT   |  |
| TYPE      |  |
| SPECIFIER |  |
| QUANTITY  |  |
| DATE      |  |

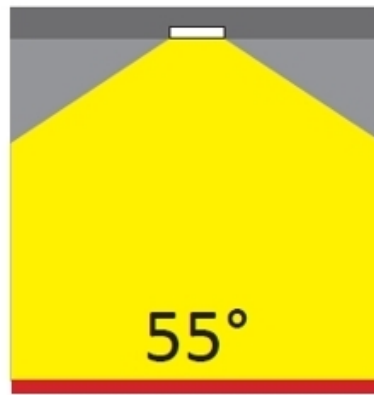
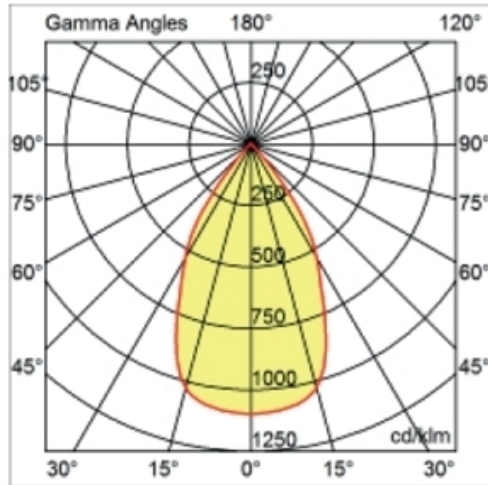

|                   |           |           |   |
|-------------------|-----------|-----------|---|
|                   | DP        | DV        |   |
| Dimming           | Phase     | 0-10V     |  |
| Color Temperature | 27K 2700K | 30K 3000K | 35K 3500K 40K 4000K   |
|                   |           |           | <b>K°</b>   |

Order Example  **K°**  
**L5XXXXXX-DV-30K**  
 0-10V 3000K



## DIXIT RA8 RECESSED

### A56057-

base number            Color             
Temperature           

- To build a product code in our configurator select the specify button on the base model # product page
- To build a manual product code on this datasheet choose from the options listed below in blue font and add the suffix to the base model #

#### GENERAL

Series: Dixit  
Subseries: Dixit RA8  
Brand: Ivela  
Division: Architectural  
Mounting Type: Recessed  
Mounting Location: Ceiling  
Subcategory: Downlight

#### PHYSICAL

Shape: Square  
Length (mm): 80  
Length (in): 3 1/8  
Width (mm): 80  
Width (in): 3 1/8  
Height (mm): 70  
Height (in): 2 3/4  
Min. Recessing Depth (mm): 110  
Min. Recessing Depth (in): 4 3/16  
Light Distribution: Direct  
Weight (kg): 0.4  
Weight (lbs): 0.88  
Diffuser: Clear Polycarbonate  
Fixture Finish: MWH  
Fixture Material: Aluminum Die Cast  
Cut-out Measurements: 70mm / 2 3/4"

#### ELECTRICAL

Lamp Type: LED  
Total Output Wattage (W): 9 / 12  
Dimming: Tri-Mode (Non-Dimming and Phase Dimming (120Vac only) and 0-10V Dimming)  
Driver Included: No  
Driver Location: Recessed Housing  
Driver Type: Constant Current - Universal  
Driver Class: Class 2  
Input Voltage (V): 120 - 277  
Constant Current (MA): 250 / 350

#### LED

Number of LEDs: 1  
Color Temperature (°K): 2700 / 3000  
Max. Delivered Lumen (lm): 1096 / 1447  
CRI: >80 CRI  
Efficiency (%): 87.7  
Lamp Life (hrs): 50000  
Upon Request: 3500K upon request

#### OPTICAL

Optic°: 26  
Adjustability: Fixed  
Upon Request: Optic 45° (mirror-metallized) / 65° (white)

#### RATINGS AND CERTIFICATIONS

Certified By: Certified for North American Standards  
IP rating: IP44  
IK Rating: IK08  
Glare Rating: ≤ 19

|           |       |
|-----------|-------|
| PROJECT   | _____ |
| TYPE      | _____ |
| SPECIFIER | _____ |
| QUANTITY  | _____ |
| DATE      | _____ |

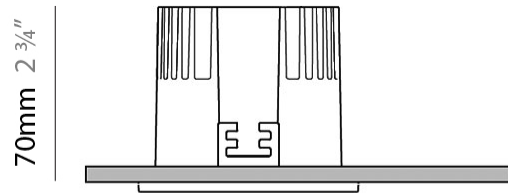

80mm 3 1/8"

51mm 2"

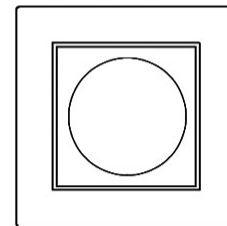

  
70mm  
2 3/4"

4 5/16"  
110mm





## DIXIT RA8 RECESSED

A56057-

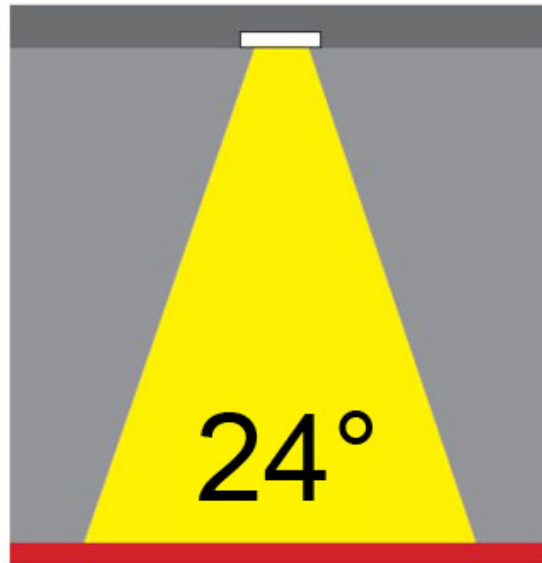
|           |  |
|-----------|--|
| PROJECT   |  |
| TYPE      |  |
| SPECIFIER |  |
| QUANTITY  |  |
| DATE      |  |



|                   |       |       |   |                        |   |       |
|-------------------|-------|-------|---|------------------------|---|-------|
|                   | DP    | DV    |  | Order Example          |  | K°    |
| Dimming           | Phase | 0-10V |   | <b>L5XXXXXX-DV-30K</b> |   |       |
| Color Temperature | 27K   | 30K   | 35K   | 40K                    | 0-10V   | 3000K |
|                   | 2700K | 3000K | 3500K   | 4000K                  |   |       |





## DIXIT RA8 RECESSED

### A56061-

base number \_\_\_\_\_  
 Color \_\_\_\_\_  
 Temperature \_\_\_\_\_

- To build a product code in our configurator select the specify button on the base model # product page
- To build a manual product code on this datasheet choose from the options listed below in blue font and add the suffix to the base model #

#### GENERAL

Series: Dixit  
 Subseries: Dixit RA8  
 Brand: Ivela  
 Division: Architectural  
 Mounting Type: Recessed  
 Mounting Location: Ceiling  
 Subcategory: Downlight

#### PHYSICAL

Shape: Round  
 Diameter (mm): 96  
 Diameter (in): 3 ¾  
 Height (mm): 85  
 Height (in): 3 ⅜  
 Min. Recessing Depth (mm): 125  
 Min. Recessing Depth (in): 4 ⅙  
 Light Distribution: Direct  
 Weight (kg): 0.3  
 Weight (lbs): 0.66  
 Diffuser: Clear Polycarbonate  
 Fixture Finish: MWH  
 Fixture Material: Aluminum Die Cast  
 Cut-out Measurements: 92mm / 3 5/8"

#### ELECTRICAL

Lamp Type: LED  
 Total Output Wattage (W): 5.5 / 8.5  
 Dimming: Tri-Mode (Non-Dimming and Phase Dimming (120Vac only) and 0-10V Dimming)  
 Driver Included: No  
 Driver Location: Recessed Housing  
 Driver Type: Constant Current - Universal  
 Driver Class: Class 2  
 Input Voltage (V): 120 - 277  
 Constant Current (MA): 350 / 500

#### LED

Number of LEDs: 1  
 Color Temperature (°K): 2700 / 3000  
 Max. Delivered Lumen (lm): 501 / 638  
 CRI: >90 CRI  
 Efficiency (%): 87.7  
 Lamp Life (hrs): 50000  
 Upon Request: 3500K upon request

#### OPTICAL

Optic°: 26  
 Beam Angle: Symmetric  
 Adjustability: Fixed  
 Upon Request: Optic 45° (mirror-metallized) / 65° (white)

#### RATINGS AND CERTIFICATIONS

Certified By: Certified for North American Standards  
 IP rating: IP44  
 IK Rating: IK08

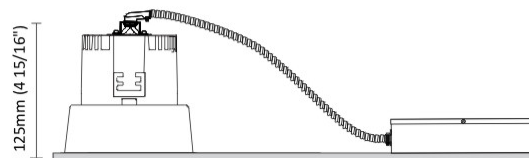
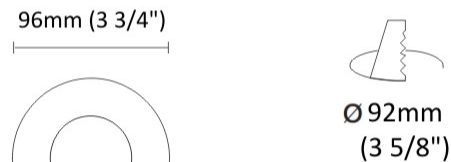
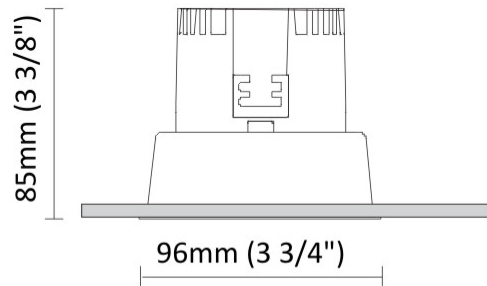

## DIXIT RA8 RECESSED

A56061-

|           |  |
|-----------|--|
| PROJECT   |  |
| TYPE      |  |
| SPECIFIER |  |
| QUANTITY  |  |
| DATE      |  |



| RA 8 TL DIXIT LED 6,5W 550 lm |      |         |         | R:100%    |  |      |      | I.Max:2958 Cd/Klm |         |          |  |
|-------------------------------|------|---------|---------|-----------|--|------|------|-------------------|---------|----------|--|
| H[m]                          | D[m] | Max lux | Med lux | Alpha=26° |  | H[m] | D[m] | Max lux           | Med lux | Beta=26° |  |
| 1.00                          | 0.47 | 1508    | 939     |           |  | 1.00 | 0.47 | 1508              | 939     |          |  |
| 2.00                          | 0.94 | 377     | 235     |           |  | 2.00 | 0.94 | 377               | 235     |          |  |
| 3.00                          | 1.41 | 168     | 104     |           |  | 3.00 | 1.41 | 168               | 104     |          |  |
| 4.00                          | 1.89 | 94      | 59      |           |  | 4.00 | 1.89 | 94                | 59      |          |  |
| 5.00                          | 2.36 | 60      | 38      |           |  | 5.00 | 2.36 | 60                | 38      |          |  |

|                   |       |       |    |
|-------------------|-------|-------|----|
| Dimming           | DP    | DV    | K° |
|                   | Phase | 0-10V |    |
| Color Temperature | 27K   | 30K   | K° |
|                   | 2700K | 3000K |    |

Order Example **L5XXXXXX-DV-30K**

**0-10V** **3000K**



|           |       |
|-----------|-------|
| PROJECT   | _____ |
| TYPE      | _____ |
| SPECIFIER | _____ |
| QUANTITY  | _____ |
| DATE      | _____ |

## DIXIT RA8 RECESSED

### A56063-

base number \_\_\_\_\_  
 Color \_\_\_\_\_  
 Temperature \_\_\_\_\_

- To build a product code in our configurator select the specify button on the base model # product page
- To build a manual product code on this datasheet choose from the options listed below in blue font and add the suffix to the base model #

#### GENERAL

Series: Dixit  
 Subseries: Dixit RA8  
 Brand: Ivela  
 Division: Architectural  
 Mounting Type: Recessed  
 Mounting Location: Ceiling  
 Subcategory: Downlight

#### PHYSICAL

Shape: Round  
 Diameter (mm): 96  
 Diameter (in): 3 3/4  
 Height (mm): 110  
 Height (in): 4 5/16  
 Min. Recessing Depth (mm): 150  
 Min. Recessing Depth (in): 5 7/8  
 Light Distribution: Direct  
 Weight (kg): 0.4  
 Weight (lbs): 0.88  
 Diffuser: Clear Polycarbonate  
 Fixture Finish: MWH  
 Fixture Material: Aluminum Die Cast  
 Cut-out Measurements: 92mm / 3 5/8"

#### ELECTRICAL

Lamp Type: LED  
 Total Output Wattage (W): 9 / 12  
 Dimming: Tri-Mode (Non-Dimming and Phase Dimming (120Vac only) and 0-10V Dimming)  
 Driver Included: No  
 Driver Location: Recessed Housing  
 Driver Type: Constant Current - Universal  
 Driver Class: Class 2  
 Input Voltage (V): 120 - 277  
 Constant Current (MA): 250 / 350

#### LED

Number of LEDs: 1  
 Color Temperature (°K): 2700 / 3000  
 Max. Delivered Lumen (lm): 1096 / 1447  
 CRI: >80 CRI  
 Efficiency (%): 87.7  
 Lamp Life (hrs): 50000  
 Upon Request: 3500K upon request

#### OPTICAL

Optic°: 26  
 Beam Angle: Symmetric  
 Adjustability: Fixed  
 Upon Request: Optic 45° (mirror-metallized) / 65° (white)

#### RATINGS AND CERTIFICATIONS

Certified By: Certified for North American Standards  
 IP rating: IP44  
 IK Rating: IK08

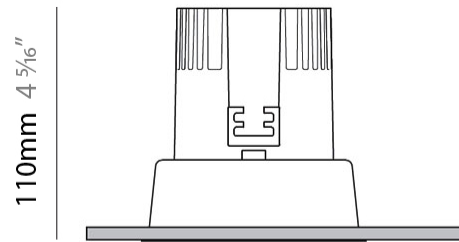

Ø96mm 3 3/4"

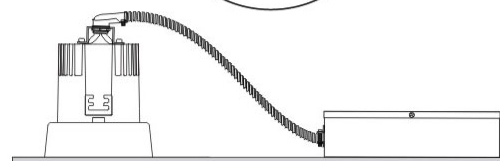
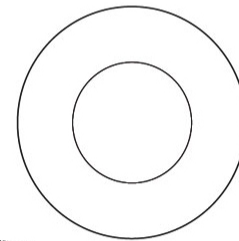

## DIXIT RA8 RECESSED

A56063-

|           |
|-----------|
| PROJECT   |
| TYPE      |
| SPECIFIER |
| QUANTITY  |
| DATE      |

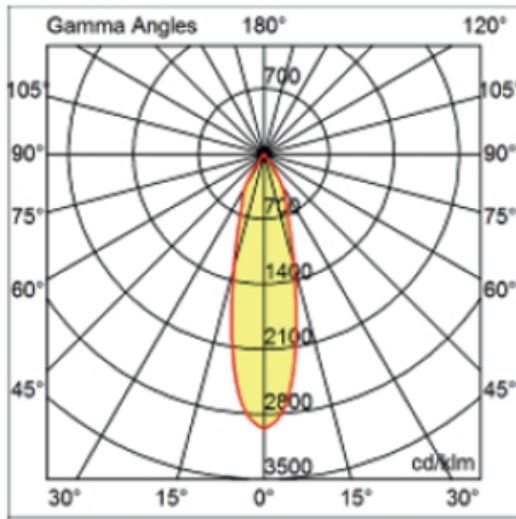

|                   |       |       |       |                 |       |
|-------------------|-------|-------|-------|-----------------|-------|
|                   | DP    | DV    |       | Order Example   | K°    |
| Dimming           | Phase | 0-10V |       | L5XXXXXX-DV-30K |       |
| Color Temperature | 27K   | 30K   | 35K   | 0-10V           | 3000K |
|                   | 2700K | 3000K | 3500K |                 |       |

A

|           |  |
|-----------|--|
| PROJECT   |  |
| TYPE      |  |
| SPECIFIER |  |
| QUANTITY  |  |
| DATE      |  |

## DIXIT RA8 RECESSED

### A56069-

base number            Color             
Temperature           

- To build a product code in our configurator select the specify button on the base model # product page
- To build a manual product code on this datasheet choose from the options listed below in blue font and add the suffix to the base model #

#### GENERAL

Series: Dixit  
Subseries: Dixit RA8  
Brand: Ivela  
Division: Architectural  
Mounting Type: Recessed  
Mounting Location: Ceiling  
Subcategory: Downlight

#### PHYSICAL

Shape: Round  
Diameter (mm): 80  
Diameter (in): 3 1/8  
Height (mm): 74  
Height (in): 2 15/16  
Min. Recessing Depth (mm): 114  
Min. Recessing Depth (in): 4 1/2  
Light Distribution: Direct  
Weight (kg): 0.4  
Weight (lbs): 0.88  
Diffuser: Clear Polycarbonate  
Fixture Finish: MWH  
Fixture Material: Aluminum Die Cast  
Cut-out Measurements: 70mm / 2 3/4"

#### ELECTRICAL

Lamp Type: LED  
Total Output Wattage (W): 9 / 12  
Dimming: Tri-Mode (Non-Dimming and Phase Dimming (120Vac only) and 0-10V Dimming)  
Driver Included: No  
Driver Location: Recessed Housing  
Driver Type: Constant Current - Universal  
Driver Class: Class 2  
Input Voltage (V): 120 - 277  
Constant Current (MA): 250 / 350

#### LED

Number of LEDs: 1  
Color Temperature (°K): 2700 / 3000  
Max. Delivered Lumen (lm): 1096 / 1447  
CRI: >80 CRI  
Efficiency (%): 88  
Lamp Life (hrs): 50000  
Upon Request: 3500K upon request

#### OPTICAL

Optic°: 26  
Adjustability: Fixed  
Upon Request: Optic 45° (mirror-metallized) / 65° (white)

#### RATINGS AND CERTIFICATIONS

Certified By: Certified for North American Standards  
IP rating: IP44  
IK Rating: IK08  
Glare Rating: ≤ 19

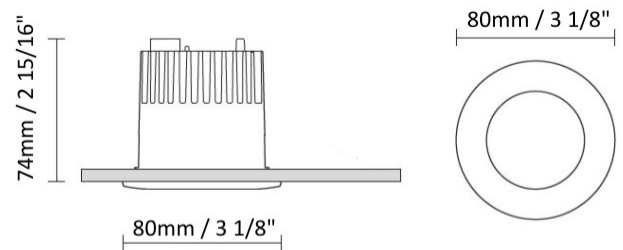

Ø 70mm (2 3/4")

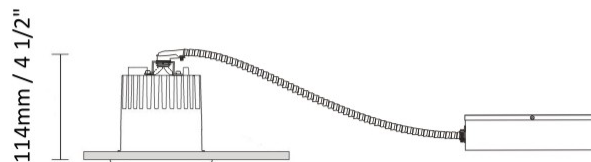

## DIXIT RA8 RECESSED

A56069-

|           |  |
|-----------|--|
| PROJECT   |  |
| TYPE      |  |
| SPECIFIER |  |
| QUANTITY  |  |
| DATE      |  |

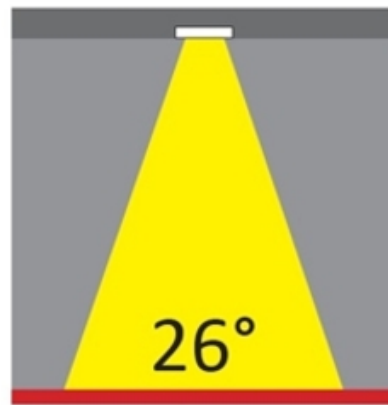

|                   |           |           |   |
|-------------------|-----------|-----------|---|
|                   | DP        | DV        |   |
| Dimming           | Phase     | 0-10V     |  |
| Color Temperature | 27K 2700K | 30K 3000K | 35K 3500K 40K 4000K   |
|                   |           |           | <b>K°</b>   |

Order Example  **K°**  
**L5XXXXXX-DV-30K**  
 0-10V 3000K



## DIXIT RA8 RECESSED

### A56073-

base number Color  
Temperature

|           |
|-----------|
| PROJECT   |
| TYPE      |
| SPECIFIER |
| QUANTITY  |
| DATE      |

- To build a product code in our configurator select the specify button on the base model # product page
- To build a manual product code on this datasheet choose from the options listed below in blue font and add the suffix to the base model #

#### GENERAL

Series: Dixit  
 Subseries: Dixit RA8  
 Brand: Ivela  
 Division: Architectural  
 Mounting Type: Recessed  
 Mounting Location: Ceiling  
 Subcategory: Downlight

#### PHYSICAL

Shape: Round  
 Diameter (mm): 95  
 Diameter (in): 3 3/4  
 Height (mm): 82  
 Height (in): 3 1/4  
 Min. Recessing Depth (mm): 122  
 Min. Recessing Depth (in): 4 13/16  
 Light Distribution: Adjustable / Direct  
 Weight (kg): 0.4  
 Weight (lbs): 0.88  
 Diffuser: Clear Polycarbonate  
 Fixture Finish: MWH  
 Fixture Material: Aluminum Die Cast  
 Cut-out Measurements: 86mm / 3 3/8"

#### ELECTRICAL

Lamp Type: LED  
 Total Output Wattage (W): 9 / 12  
 Dimming: Tri-Mode (Non-Dimming and Phase Dimming (120Vac only) and 0-10V Dimming)  
 Driver Included: No  
 Driver Location: Recessed Housing  
 Driver Type: Constant Current - Universal  
 Driver Class: Class 2  
 Input Voltage (V): 120 - 277  
 Constant Current (MA): 250 / 350

#### LED

Number of LEDs: 1  
 Color Temperature (°K): 2700 / 3000 / 4000  
 Max. Delivered Lumen (lm): 1096 / 1447  
 CRI: >80 CRI  
 Efficiency (%): 87.7  
 Lamp Life (hrs): 50000  
 Upon Request: 3500K upon request

#### OPTICAL

Optic°: 26  
 Beam Angle: Symmetric  
 Adjustability: Tilt ±20°  
 Upon Request: Optic 45° (mirror-metallized) / 65° (white)

#### RATINGS AND CERTIFICATIONS

Certified By: Certified for North American Standards  
 IP rating: IP20  
 IK Rating: IK08  
 Glare Rating: ≤ 19

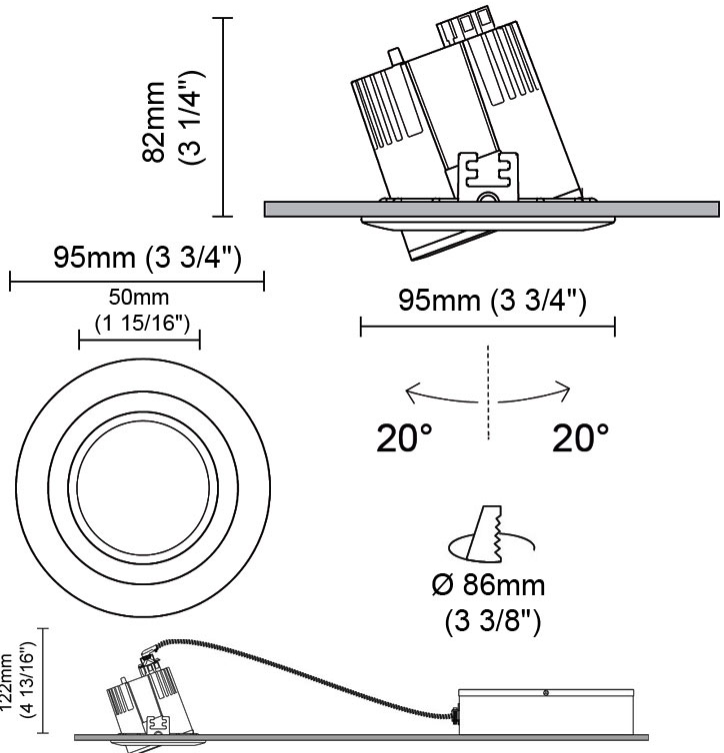

## DIXIT RA8 RECESSED

A56073-

|           |
|-----------|
| PROJECT   |
| TYPE      |
| SPECIFIER |
| QUANTITY  |
| DATE      |

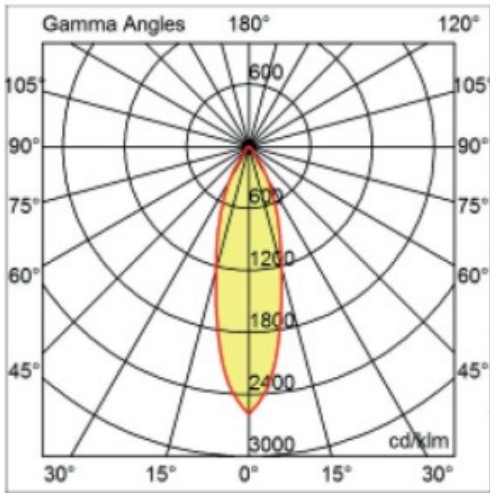

26°

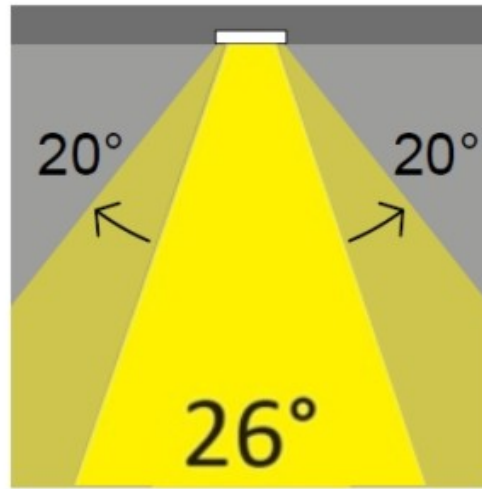

|                   |       |       |       |       |    |
|-------------------|-------|-------|-------|-------|----|
|                   | DP    | DV    |       |       |    |
| Dimming           | Phase | 0-10V |       |       |    |
| Color Temperature | 27K   | 30K   | 35K   | 40K   | K° |
|                   | 2700K | 3000K | 3500K | 4000K |    |

Order Example  **K°**  
**L5XXXXXX-DV-30K**  
 0-10V 3000K

A



## DIXIT RA8 RECESSED

### A56077-

base number \_\_\_\_\_  
 Color \_\_\_\_\_  
 Temperature \_\_\_\_\_

- To build a product code in our configurator select the specify button on the base model # product page
- To build a manual product code on this datasheet choose from the options listed below in blue font and add the suffix to the base model #

#### GENERAL

Series: Dixit \_\_\_\_\_  
 Subseries: Dixit RA8 \_\_\_\_\_  
 Brand: Ivela \_\_\_\_\_  
 Division: Architectural \_\_\_\_\_  
 Mounting Type: Recessed \_\_\_\_\_  
 Mounting Location: Ceiling \_\_\_\_\_  
 Subcategory: Downlight \_\_\_\_\_

#### PHYSICAL

Shape: Round \_\_\_\_\_  
 Diameter (mm): 103 \_\_\_\_\_  
 Diameter (in): 4 1/16 \_\_\_\_\_  
 Height (mm): 85 \_\_\_\_\_  
 Height (in): 3 3/8 \_\_\_\_\_  
 Min. Recessing Depth (mm): 125 \_\_\_\_\_  
 Min. Recessing Depth (in): 4 15/16 \_\_\_\_\_  
 Light Distribution: Direct \_\_\_\_\_  
 Weight (kg): 0.3 \_\_\_\_\_  
 Weight (lbs): 0.66 \_\_\_\_\_  
 Diffuser: Clear Polycarbonate \_\_\_\_\_  
 Fixture Finish: MWH \_\_\_\_\_  
 Fixture Material: Aluminum Die Cast \_\_\_\_\_  
 Cut-out Measurements: 96mm / 3 3/4" \_\_\_\_\_

#### ELECTRICAL

Lamp Type: LED \_\_\_\_\_  
 Total Output Wattage (W): 9 / 12 \_\_\_\_\_  
 Dimming: Tri-Mode (Non-Dimming and Phase Dimming (120Vac only) and 0-10V Dimming) \_\_\_\_\_  
 Driver Included: No \_\_\_\_\_  
 Driver Location: Recessed Housing \_\_\_\_\_  
 Driver Type: Constant Current - Universal \_\_\_\_\_  
 Driver Class: Class 2 \_\_\_\_\_  
 Input Voltage (V): 120 - 277 \_\_\_\_\_  
 Constant Current (MA): 250 / 350 \_\_\_\_\_

#### LED

Number of LEDs: 1 \_\_\_\_\_  
 Color Temperature (°K): 2700 / 3000 \_\_\_\_\_  
 Max. Delivered Lumen (lm): 1096 / 1447 \_\_\_\_\_  
 CRI: >90 CRI \_\_\_\_\_  
 Efficiency (%): 73 \_\_\_\_\_  
 Lamp Life (hrs): 50000 \_\_\_\_\_  
 Upon Request: 3500K upon request \_\_\_\_\_

#### OPTICAL

Optic°: 26 \_\_\_\_\_  
 Adjustability: Fixed \_\_\_\_\_

#### RATINGS AND CERTIFICATIONS

Certified By: Certified for North American Standards \_\_\_\_\_  
 IP rating: IP43 \_\_\_\_\_

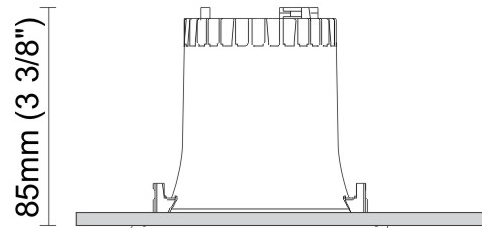

103mm (4 1/16")

103mm (4 1/16")



Ø96mm  
(3 3/4")



## DIXIT RA8 RECESSED

A56077-

|           |  |
|-----------|--|
| PROJECT   |  |
| TYPE      |  |
| SPECIFIER |  |
| QUANTITY  |  |
| DATE      |  |

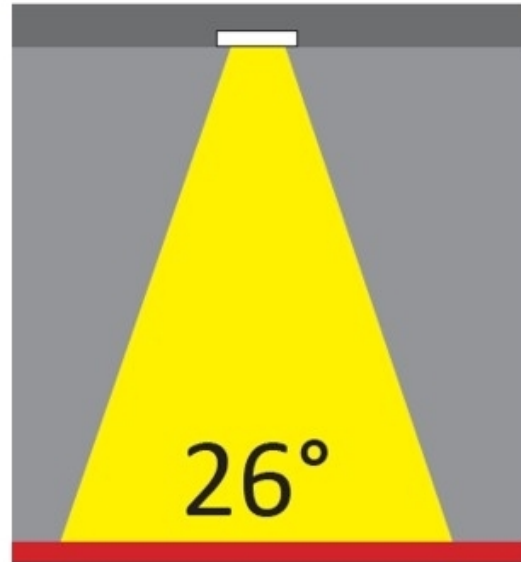
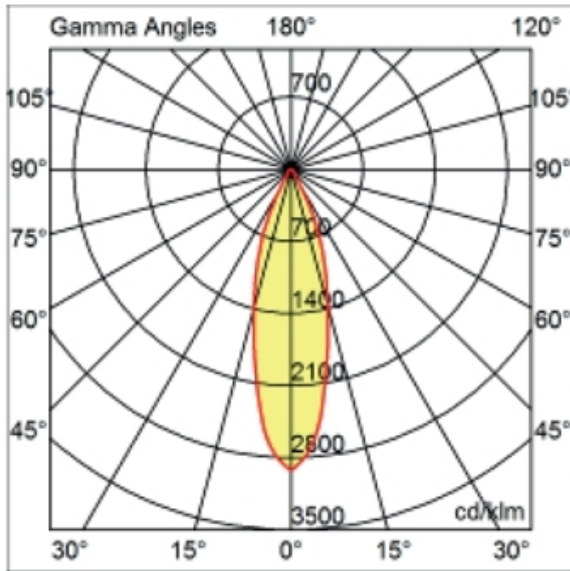

|                   |       |       |       |
|-------------------|-------|-------|-------|
|                   | DP    | DV    |       |
| Dimming           | Phase | 0-10V |       |
| Color Temperature | 27K   | 30K   | 35K   |
|                   | 2700K | 3000K | 3500K |

Order Example  **K°**  
**L5XXXXXX-DV-30K**  
 0-10V **3000K**

A

|           |       |
|-----------|-------|
| PROJECT   | _____ |
| TYPE      | _____ |
| SPECIFIER | _____ |
| QUANTITY  | _____ |
| DATE      | _____ |

## DIXIT RA14 RECESSED

### A56093-

base number \_\_\_\_\_  
 Color \_\_\_\_\_  
 Temperature \_\_\_\_\_

- To build a product code in our configurator select the specify button on the base model # product page
- To build a manual product code on this datasheet choose from the options listed below in blue font and add the suffix to the base model #

#### GENERAL

Series: Dixit  
 Subseries: Dixit RA14  
 Brand: Ivela  
 Division: Architectural  
 Mounting Type: Recessed  
 Mounting Location: Ceiling  
 Subcategory: Downlight

#### PHYSICAL

Shape: Round  
 Diameter (mm): 140  
 Diameter (in): 5 1/2  
 Height (mm): 92  
 Height (in): 3 5/8  
 Min. Recessing Depth (mm): 132  
 Min. Recessing Depth (in): 5 3/16  
 Light Distribution: Direct  
 Weight (kg): 0.7  
 Weight (lbs): 1.54  
 Diffuser: Clear Polycarbonate  
 Fixture Finish: MWH  
 Fixture Material: Aluminum Die Cast  
 Cut-out Measurements: 126mm / 4 15/16"

#### ELECTRICAL

Lamp Type: LED  
 Total Output Wattage (W): 26 / 33 / 38  
 Dimming: Tri-Mode (Non-Dimming and Phase Dimming (120Vac only) and 0-10V Dimming)  
 Driver Included: No  
 Driver Location: Recessed Housing  
 Driver Type: Constant Current - Universal  
 Driver Class: Class 2  
 Input Voltage (V): 120 - 277  
 Constant Current (MA): 700 / 900 / 1050

#### LED

Number of LEDs: 1  
 Color Temperature (°K): 2700 / 3000 / 4000  
 Max. Delivered Lumen (lm): 2924 - 3100 / 3655 - 3748 / 4214 - 4300  
 CRI: >85 CRI  
 Efficiency (%): 86  
 Lamp Life (hrs): 50000  
 Upon Request: 3500K

#### OPTICAL

Optic°: 60  
 Beam Angle: Symmetric  
 Adjustability: Fixed

#### RATINGS AND CERTIFICATIONS

Certified By: CSA Certified to UL and CSA Standards  
 IP Rating: IP44  
 IK Rating: IK08

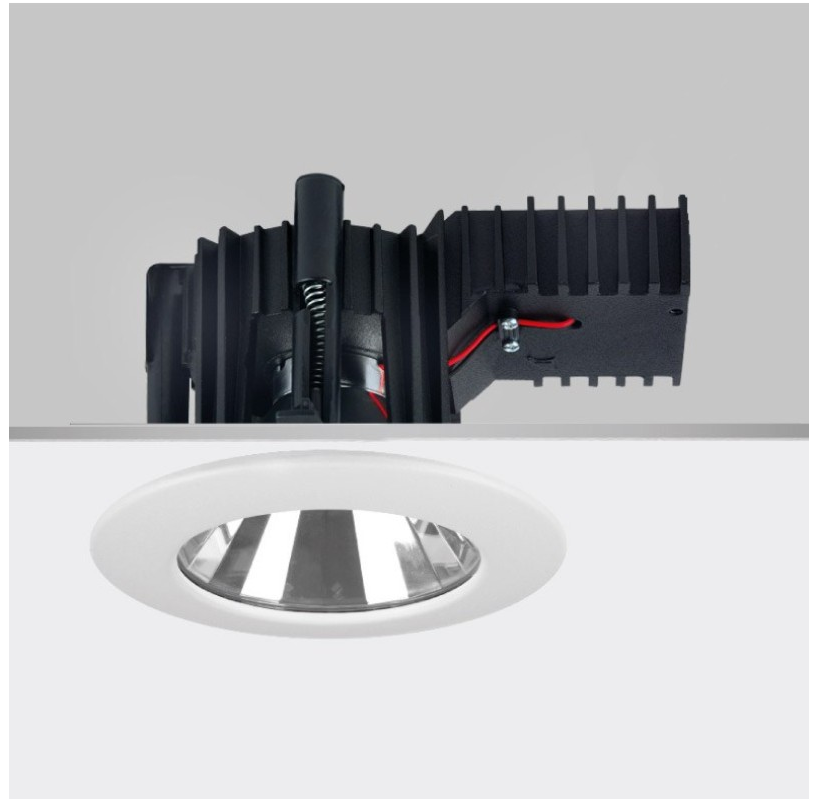

## DIXIT RA14 RECESSED

A56093-

|           |  |
|-----------|--|
| PROJECT   |  |
| TYPE      |  |
| SPECIFIER |  |
| QUANTITY  |  |
| DATE      |  |



Matte White



Silver

|                   |       |       |       |       |
|-------------------|-------|-------|-------|-------|
|                   | DP    | DV    |       |       |
| Dimming           | Phase | 0-10V |       |       |
| Color Temperature | 27K   | 30K   | 35K   | 40K   |
|                   | 2700K | 3000K | 3500K | 4000K |

Order Example  **K°**  
**L5XXXXXX-DV-30K**  
 0-10V  
 3000K



## DIXIT RA16 RECESSED

### A56102-

base number \_\_\_\_\_  
 Color \_\_\_\_\_  
 Temperature \_\_\_\_\_

- To build a product code in our configurator select the specify button on the base model # product page
- To build a manual product code on this datasheet choose from the options listed below in blue font and add the suffix to the base model #

#### GENERAL

Series: Dixit  
 Subseries: Dixit RA16  
 Brand: Ivela  
 Division: Architectural  
 Mounting Type: Recessed  
 Mounting Location: Ceiling  
 Subcategory: Downlight

#### PHYSICAL

Shape: Round  
 Diameter (mm): 160  
 Diameter (in): 6 5/16  
 Height (mm): 42  
 Height (in): 1 5/8  
 Min. Recessing Depth (mm): 82  
 Min. Recessing Depth (in): 3 1/4  
 Light Distribution: Direct  
 Weight (kg): 0.7  
 Weight (lbs): 15.43  
 Diffuser: Polycarbonate - Opal  
 Fixture Finish: MWH  
 Fixture Material: Aluminum Die Cast  
 Cut-out Measurements: 155mm / 6 1/8"

#### ELECTRICAL

Lamp Type: LED  
 Total Output Wattage (W): 18  
 Dimming: Tri-Mode (Non-Dimming and Phase Dimming (120Vac only) and 0-10V Dimming)  
 Driver Included: No  
 Driver Location: Recessed Housing  
 Driver Type: Constant Current - Universal  
 Driver Class: Class 2  
 Input Voltage (V): 120 - 277  
 Constant Current (MA): 500

#### LED

Number of LEDs: 1  
 Color Temperature (°K): 2700 / 3000 / 3500 / 4000  
 Max. Delivered Lumen (lm): 1745 / 1781  
 CRI: >85 CRI  
 Efficiency (%): 72.7  
 Lamp Life (hrs): 50000

#### OPTICAL

Optic°: 110  
 Beam Angle: Symmetric  
 Adjustability: Fixed

#### RATINGS AND CERTIFICATIONS

Certified By: Certified for North American Standards  
 IP rating: IP44  
 IK Rating: IK07

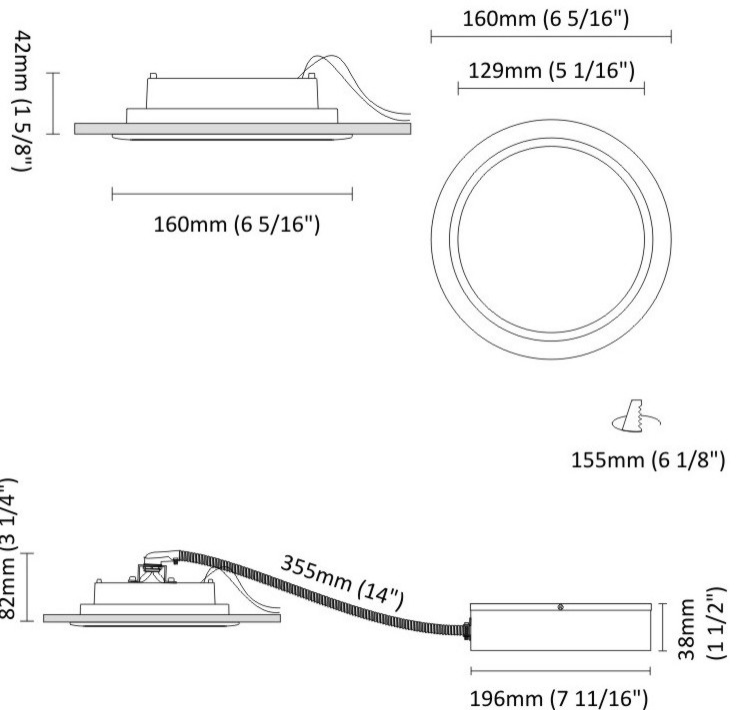

## DIXIT RA16 RECESSED

A56102-

|           |  |
|-----------|--|
| PROJECT   |  |
| TYPE      |  |
| SPECIFIER |  |
| QUANTITY  |  |
| DATE      |  |

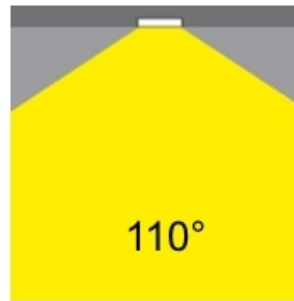
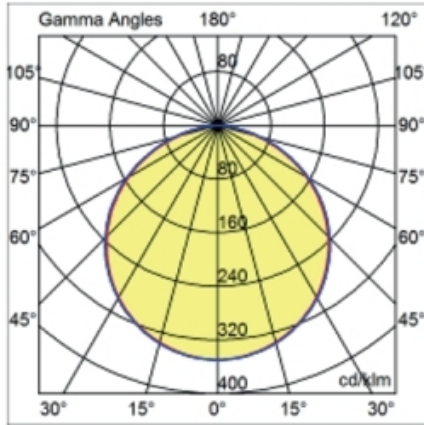

| RA 16 LED 18W 2400 lm |       |         |         |            | R:100% |       |         |         | I.Max:350 Cd/Klm |      |       |         |         |
|-----------------------|-------|---------|---------|------------|--------|-------|---------|---------|------------------|------|-------|---------|---------|
| H[m]                  | D[m]  | Max lux | Med lux | Alpha=112° | H[m]   | D[m]  | Max lux | Med lux | Beta=113°        | H[m] | D[m]  | Max lux | Med lux |
| 1.00                  | 2.99  | 604     | 145     |            | 1.00   | 3.07  | 604     | 145     |                  | 1.00 | 3.07  | 604     | 145     |
| 2.00                  | 5.98  | 151     | 36      |            | 2.00   | 6.13  | 151     | 36      |                  | 2.00 | 6.13  | 151     | 36      |
| 3.00                  | 8.96  | 67      | 16      |            | 3.00   | 9.20  | 67      | 16      |                  | 3.00 | 9.20  | 67      | 16      |
| 4.00                  | 11.95 | 38      | 9       |            | 4.00   | 12.26 | 38      | 9       |                  | 4.00 | 12.26 | 38      | 9       |
| 5.00                  | 14.94 | 24      | 6       |            | 5.00   | 15.33 | 24      | 6       |                  | 5.00 | 15.33 | 24      | 6       |

|                   |       |       |       |       |
|-------------------|-------|-------|-------|-------|
| Dimming           | DP    | DV    |       |       |
|                   | Phase | 0-10V |       |       |
| Color Temperature | 27K   | 30K   | 35K   | 40K   |
|                   | 2700K | 3000K | 3500K | 4000K |

Order Example **K°**

**L5XXXXXX-DV-30K**

0-10V

3000K



## DIXIT RA23 RECESSED

### A56112-

base number \_\_\_\_\_ Color \_\_\_\_\_  
Temperature \_\_\_\_\_

1. To build a product code in our configurator select the specify button on the base model # product page
2. To build a manual product code on this datasheet choose from the options listed below in blue font and add the suffix to the base model #

#### GENERAL

Series: Dixit  
Subseries: Dixit RA23  
Brand: Ivela  
Division: Architectural  
Mounting Type: Recessed  
Mounting Location: Ceiling  
Subcategory: Downlight

#### PHYSICAL

Shape: Round  
Diameter (mm): 235  
Diameter (in): 9 ¼  
Height (mm): 155  
Height (in): 6 ⅛  
Min. Recessing Depth (mm): 155  
Min. Recessing Depth (in): 6 ⅛  
Light Distribution: Direct  
Weight (kg): 3.6  
Weight (lbs): 7.93  
Diffuser: Tempered Safety glass 4mm / 5/32"  
Fixture Finish: MWH  
Fixture Material: Aluminum Die Cast  
Cut-out Measurements: 220mm / 8 5/8"

#### ELECTRICAL

Lamp Type: LED  
Total Output Wattage (W): 51  
Dimming: Tri-Mode (Non-Dimming and Phase Dimming (120Vac only) and 0-10V Dimming)  
Driver Included: No  
Driver Location: Recessed Housing  
Driver Type: Constant Current - Universal  
Driver Class: Class 2  
Housing: See Components  
Input Voltage (V): 120 - 277  
Constant Current (MA): 1400

#### LED

Number of LEDs: 1  
Color Temperature (°K): 2700 / 3000 / 4000  
Max. Delivered Lumen (lm): 5711 / 5827 / 5878 / 5998  
CRI: >80 CRI  
Efficiency (%): 85.7  
Lamp Life (hrs): 50000  
Upon Request: 3500K upon request

#### OPTICAL

Optic°: 100  
Beam Angle: Symmetric  
Adjustability: Fixed

#### RATINGS AND CERTIFICATIONS

Certified By: CSA Certified to UL and CSA Standards  
IP rating: IP44  
IK Rating: IK07

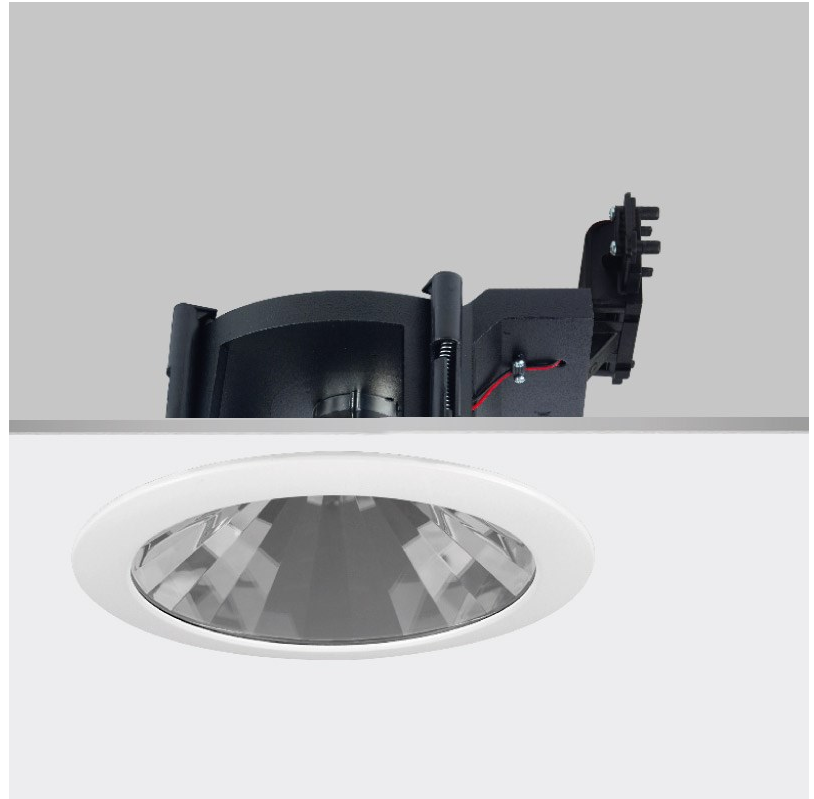

|           |       |
|-----------|-------|
| PROJECT   | _____ |
| TYPE      | _____ |
| SPECIFIER | _____ |
| QUANTITY  | _____ |
| DATE      | _____ |

## DIXIT RA8 RECESSED

### A56121-

base number \_\_\_\_\_ Color \_\_\_\_\_  
Temperature \_\_\_\_\_

- To build a product code in our configurator select the specify button on the base model # product page
- To build a manual product code on this datasheet choose from the options listed below in blue font and add the suffix to the base model #

#### GENERAL

Series: Dixit  
Subseries: Dixit RA8  
Brand: Ivela  
Division: Architectural  
Mounting Type: Recessed  
Mounting Location: Ceiling  
Subcategory: Downlight

#### PHYSICAL

Shape: Round  
Diameter (mm): 80  
Diameter (in): 3 1/8  
Height (mm): 50  
Height (in): 1 15/16  
Min. Recessing Depth (mm): 90  
Min. Recessing Depth (in): 3 9/16  
Light Distribution: Direct  
Weight (kg): 0.4  
Weight (lbs): 0.88  
Diffuser: Clear Polycarbonate  
Fixture Finish: MWH  
Fixture Material: Aluminum Die Cast  
Cut-out Measurements: 70mm / 2 3/4"

#### ELECTRICAL

Lamp Type: LED  
Total Output Wattage (W): 5.5 / 8.5  
Dimming: Tri-Mode (Non-Dimming and Phase Dimming (120Vac only) and 0-10V Dimming)  
Driver Included: No  
Driver Location: Recessed Housing  
Driver Type: Constant Current - Universal  
Driver Class: Class 2  
Input Voltage (V): 120 - 277  
Constant Current (MA): 350 / 500

#### LED

Number of LEDs: 1  
Color Temperature (°K): 2700 / 3000 / 3500 / 4000  
Max. Delivered Lumen (lm): 501 / 638  
CRI: >90 CRI  
Efficiency (%): 91  
Lamp Life (hrs): 50000

#### OPTICAL

Reflector: Mirror-metallized thermoplastic material  
Optic: 26  
Beam Angle: Symmetric  
Adjustability: Fixed  
Upon Request: Optic 45° (mirror-metallized) / 65° (white)

#### RATINGS AND CERTIFICATIONS

Certified By: CSA Certified to UL and CSA Standards  
IP rating: IP44  
IK Rating: IK08

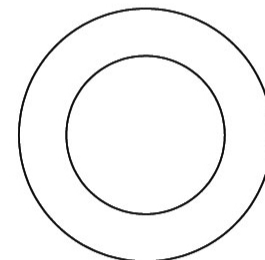
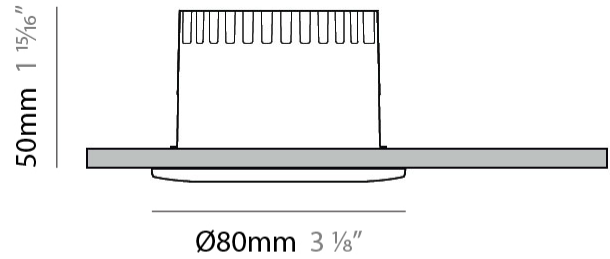





## DIXIT RA8 RECESSED

A56121-

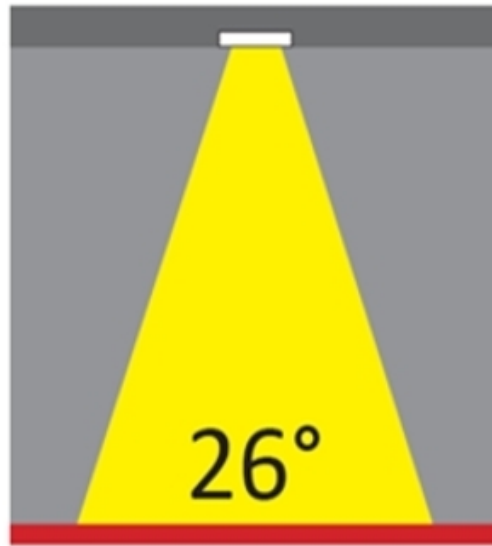
|           |  |
|-----------|--|
| PROJECT   |  |
| TYPE      |  |
| SPECIFIER |  |
| QUANTITY  |  |
| DATE      |  |



|                   |       |       |   |                        |   |       |
|-------------------|-------|-------|---|------------------------|---|-------|
|                   | DP    | DV    |  | Order Example          |  | K°    |
| Dimming           | Phase | 0-10V |   | <b>L5XXXXXX-DV-30K</b> |   |       |
| Color Temperature | 27K   | 30K   | 35K   | 40K                    |   | K°    |
|                   | 2700K | 3000K | 3500K   | 4000K                  | 0-10V   | 3000K |



PROJECT

TYPE

SPECIFIER

QUANTITY

DATE

#### Fixture Finish

Matte White - MWH



**Digital:** Not all screens are calibrated the same, and therefore, colors will appear differently between screens.

**Physical:** When texture is involved, there will be variations in color, character and tone within a product series and between product families.



|           |  |
|-----------|--|
| PROJECT   |  |
| TYPE      |  |
| SPECIFIER |  |
| QUANTITY  |  |
| DATE      |  |

### LEGEND

|   |  |  |
|---|--|--|
| floor-mounted   | pivotal  | special LED (upon request) RGB, RGBW, tunable, gold+, meat+, art+, fashion+                    |
| wall and ceiling: recessed and surface mounted            | rotating   | warm dim / natural dimming LED   |
| ceiling-mounted and wall-mounted                          | illuminate tilted  | rechargeable battery powered   |
| wall-mounted  | color of suspension cable                                    | fixture with natural vivid LED (upon request)  |
| omni-directional light distribution                       | length of suspension cable                                   | color rendering index  |
| direct light distribution                                 | reflector degree selection                                   | color temperature  |
| direct/indirect light distribution                        | super spot   | lumen (luminous flux)  |
| indirect light distribution                               | lens   | efficacy (lumens per watt)   |
| asymmetric light distribution                             | lens pack  | Unified Glare Rating (UGR) range from 5-40   |
| aura light distribution                                   | shine ring   | marine grade (AISI 316 stainless steel)  |
| round wall or ceiling cut-out                             | integrated shine ring with diffuser                          | walk on  |
| square wall or ceiling cut-out                            | free individual colors 01-29                                 | drive on   |
| the supplied jig specifies the cutout dimensions          | individual colors: 00 (free of charge), 01-25 (extra charge) | Dark Sky Compliance  |
| minimum distance (meters) lamp - object                   | luminaire part to be colored (F1)                            | Americans with Disabilities Act (less than 4" off the wall located between 27"-84" from floor) |
| recessed depth  | luminaire part to be colored (F2)                            | lamp protected against explosion   |
| ceiling thickness in mm                                   | luminaire part to be colored (F3)                            | blown glass using traditional methods by master glass blower                                   |
| ceiling thickness selection                               | luminaire part to be colored (F4)                            | acoustic material  |
| dimmable DP (phase), DV (0-10V), DD (dali), DS (step-dim) | luminaire part to be colored (F5)                            | protection class I, protection insulation  |
| included or excluded LED driver/transformer/control gear  | color of 3-circuit adaptor                                   | protection class II, protection insulation   |
| separately switchable                                     | indirect diffuser  | ETL Certified to UL and CSA Standards  |
| sensor  | direct diffuser  | UL Certified to UL and CSA Standards   |
| remote control  | ball-proof (upon request)                                    | CSA Certified to UL and CSA Standards  |
| available upon request                                    | accessory  | Certified for North American Standards   |

### IP RATING

|      |  |
|------|--|
| IP20 | protected against ingress of solid bodies greater than 12.5mm (finger)   |
| IP33 | protected against ingress of solid bodies greater than 2.5mm<br>protected against sprays of water up to 60 degrees from the vertical (rain)      |
| IP40 | protected against ingress of solid bodies greater than 1mm (wire)<br>no protection against the ingress of moisture                               |
| IP43 | protected against ingress of solid bodies greater than 1mm (wire)<br>protected against sprays of water up to 60 degrees from the vertical (rain) |
| IP44 | protected against ingress of solid bodies greater than 1mm (wire)<br>protected against water splashed from all directions                        |
| IP54 | protected against limited ingress of dust (wet rooms/covered outdoor areas)<br>protected against water splashed from all directions              |
| IP65 | protected against ingress of dust<br>protected against jets of water   |
| IP66 | protected against ingress of dust<br>protected against powerful jets of water or heavy seas  |
| IP67 | protected against ingress of dust<br>protected against immersion of water between 15cm - 1m for 30 minutes                                       |
| IP68 | protected against ingress of dust<br>protected against immersion of water under pressure for long periods  |

### IK RATING

|      |   |
|------|---|
| IK01 | protected against 0.14 joules impact (equivalent to 0.25kg mass dropped from 56mm above the surface)  |
| IK02 | protected against 0.2 joules impact (equivalent to 0.25kg mass dropped from 80mm above the surface)   |
| IK03 | protected against 0.35 joules impact (equivalent to 0.25kg mass dropped from 140mm above the surface) |
| IK04 | protected against 0.5 joules impact (equivalent to 0.25kg mass dropped from 200mm above the surface)  |
| IK05 | protected against 0.7 joules impact (equivalent to 0.25kg mass dropped from 280mm above the surface)  |
| IK06 | protected against 1 joules impact (equivalent to 0.25kg mass dropped from 400mm above the surface)    |
| IK07 | protected against 2 joules impact (equivalent to 0.5kg mass dropped from 400mm above the surface)     |
| IK08 | protected against 5 joules impact (equivalent to 1.7kg mass dropped from 300mm above the surface)     |
| IK09 | protected against 10 joules impact (equivalent to 5.0kg mass dropped from 200mm above the surface)    |
| IK10 | protected against 20 joules impact (equivalent to 5.0kg mass dropped from 400mm above the surface)    |