

DIXIT RA8 RECESSED

A56057-

base number _____ Color _____
 Temperature _____

- To build a product code in our configurator select the specify button on the base model # product page
- To build a manual product code on this datasheet choose from the options listed below in blue font and add the suffix to the base model #

GENERAL

Series: Dixit
 Subseries: Dixit RA8
 Brand: Ivela
 Division: Architectural
 Mounting Type: Recessed
 Mounting Location: Ceiling
 Subcategory: Downlight

PHYSICAL

Shape: Square
 Length (mm): 80
 Length (in): 3 1/8
 Width (mm): 80
 Width (in): 3 1/8
 Height (mm): 70
 Height (in): 2 3/4
 Min. Recessing Depth (mm): 110
 Min. Recessing Depth (in): 4 3/16
 Light Distribution: Direct
 Weight (kg): 0.4
 Weight (lbs): 0.88
 Diffuser: Clear Polycarbonate
 Fixture Finish: MWH
 Fixture Material: Aluminum Die Cast
 Cut-out Measurements: 70mm / 2 3/4"

ELECTRICAL

Lamp Type: LED
 Total Output Wattage (W): 9 / 12
 Dimming: Tri-Mode (Non-Dimming and Phase Dimming (120Vac only) and 0-10V Dimming)
 Driver Included: No
 Driver Location: Recessed Housing
 Driver Type: Constant Current - Universal
 Driver Class: Class 2
 Input Voltage (V): 120 - 277
 Constant Current (MA): 250 / 350

LED

Number of LEDs: 1
 Color Temperature (°K): 2700 / 3000
 Max. Delivered Lumen (lm): 1096 / 1447
 CRI: >80 CRI
 Efficiency (%): 87.7
 Lamp Life (hrs): 50000
 Upon Request: 3500K upon request

OPTICAL

Optic°: 26
 Adjustability: Fixed
 Upon Request: Optic 45° (mirror-metallized) / 65° (white)

RATINGS AND CERTIFICATIONS

Certified By: Certified for North American Standards
 IP rating: IP44
 IK Rating: IK08
 Glare Rating: ≤ 19



80mm 3 1/8"

51mm 2"

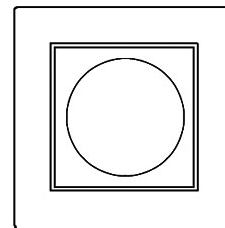

70mm
2 3/4"

4 5/16"
110mm





DIXIT RA8 RECESSED

A56057-

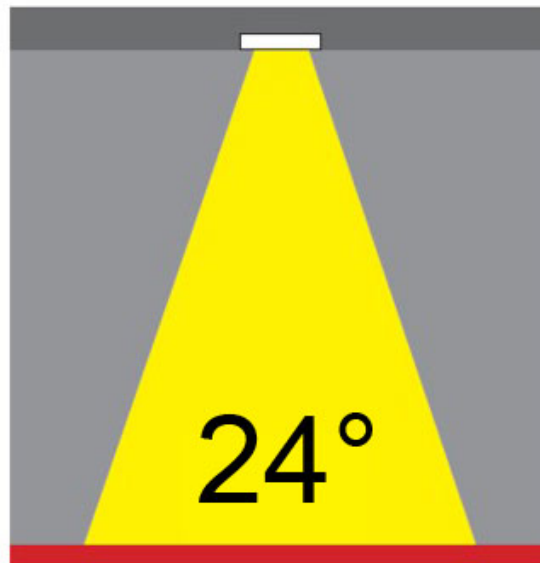
PROJECT	
TYPE	
SPECIFIER	
QUANTITY	
DATE	



	DP	DV		Order Example		K°
Dimming	Phase	0-10V		L5XXXXXX-DV-30K		
Color Temperature	27K	30K	35K	40K		K°
	2700K	3000K	3500K	4000K	0-10V	3000K



PROJECT	_____
TYPE	_____
SPECIFIER	_____
QUANTITY	_____
DATE	_____

DIXIT RA8 RECESSED

A56063-

base number _____ Color _____
Temperature _____

- To build a product code in our configurator select the specify button on the base model # product page
- To build a manual product code on this datasheet choose from the options listed below in blue font and add the suffix to the base model #

GENERAL

Series: Dixit
Subseries: Dixit RA8
Brand: Ivela
Division: Architectural
Mounting Type: Recessed
Mounting Location: Ceiling
Subcategory: Downlight

PHYSICAL

Shape: Round
Diameter (mm): 96
Diameter (in): 3 3/4
Height (mm): 110
Height (in): 4 5/16
Min. Recessing Depth (mm): 150
Min. Recessing Depth (in): 5 7/8
Light Distribution: Direct
Weight (kg): 0.4
Weight (lbs): 0.88
Diffuser: Clear Polycarbonate
Fixture Finish: MWH
Fixture Material: Aluminum Die Cast
Cut-out Measurements: 92mm / 3 5/8"

ELECTRICAL

Lamp Type: LED
Total Output Wattage (W): 9 / 12
Dimming: Tri-Mode (Non-Dimming and Phase Dimming (120Vac only) and 0-10V Dimming)
Driver Included: No
Driver Location: Recessed Housing
Driver Type: Constant Current - Universal
Driver Class: Class 2
Input Voltage (V): 120 - 277
Constant Current (MA): 250 / 350

LED

Number of LEDs: 1
Color Temperature (°K): 2700 / 3000
Max. Delivered Lumen (lm): 1096 / 1447
CRI: >80 CRI
Efficiency (%): 87.7
Lamp Life (hrs): 50000
Upon Request: 3500K upon request

OPTICAL

Optic°: 26
Beam Angle: Symmetric
Adjustability: Fixed
Upon Request: Optic 45° (mirror-metallized) / 65° (white)

RATINGS AND CERTIFICATIONS

Certified By: Certified for North American Standards
IP rating: IP44
IK Rating: IK08

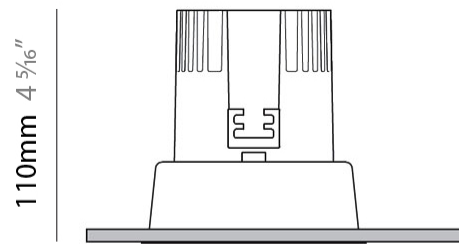

Ø96mm 3 3/4"

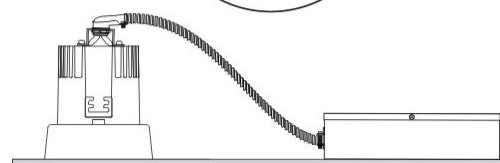
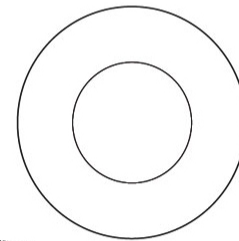

DIXIT RA8 RECESSED

A56063-

PROJECT	
TYPE	
SPECIFIER	
QUANTITY	
DATE	



	DP	DV		Order Example	K°
Dimming	Phase	0-10V		L5XXXXXX-DV-30K	
Color Temperature	27K	30K	35K	0-10V	3000K
	2700K	3000K	3500K		

A

DIXIT RA8 RECESSED

A56073-

base number Color
Temperature

PROJECT	_____
TYPE	_____
SPECIFIER	_____
QUANTITY	_____
DATE	_____

- To build a product code in our configurator select the specify button on the base model # product page
- To build a manual product code on this datasheet choose from the options listed below in blue font and add the suffix to the base model #

GENERAL

Series: Dixit
Subseries: Dixit RA8
Brand: Ivela
Division: Architectural
Mounting Type: Recessed
Mounting Location: Ceiling
Subcategory: Downlight

PHYSICAL

Shape: Round
Diameter (mm): 95
Diameter (in): 3 3/4
Height (mm): 82
Height (in): 3 1/4
Min. Recessing Depth (mm): 122
Min. Recessing Depth (in): 4 13/16
Light Distribution: Adjustable / Direct
Weight (kg): 0.4
Weight (lbs): 0.88
Diffuser: Clear Polycarbonate
Fixture Finish: MWH
Fixture Material: Aluminum Die Cast
Cut-out Measurements: 86mm / 3 3/8"

ELECTRICAL

Lamp Type: LED
Total Output Wattage (W): 9 / 12
Dimming: Tri-Mode (Non-Dimming and Phase Dimming (120Vac only) and 0-10V Dimming)
Driver Included: No
Driver Location: Recessed Housing
Driver Type: Constant Current - Universal
Driver Class: Class 2
Input Voltage (V): 120 - 277
Constant Current (MA): 250 / 350

LED

Number of LEDs: 1
Color Temperature (°K): 2700 / 3000 / 4000
Max. Delivered Lumen (lm): 1096 / 1447
CRI: >80 CRI
Efficiency (%): 87.7
Lamp Life (hrs): 50000
Upon Request: 3500K upon request

OPTICAL

Optic°: 26
Beam Angle: Symmetric
Adjustability: Tilt ±20°
Upon Request: Optic 45° (mirror-metallized) / 65° (white)

RATINGS AND CERTIFICATIONS

Certified By: Certified for North American Standards
IP rating: IP20
IK Rating: IK08
Glare Rating: ≤ 19

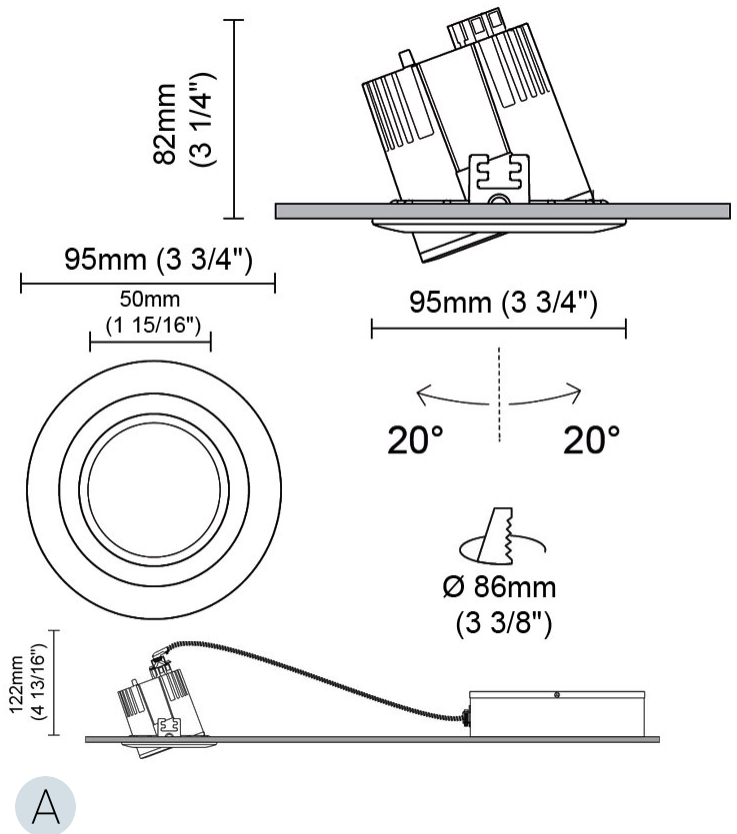

DIXIT RA8 RECESSED

A56073-

PROJECT
TYPE
SPECIFIER
QUANTITY
DATE

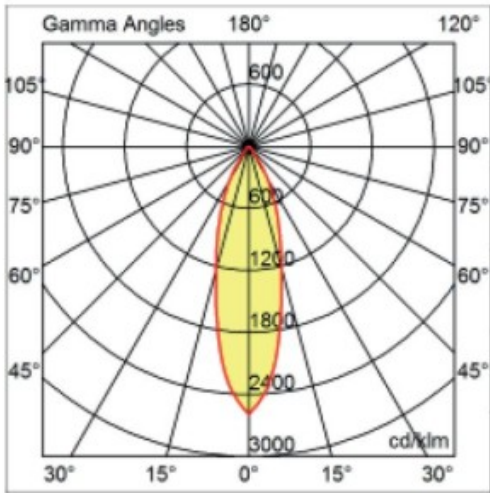

26°

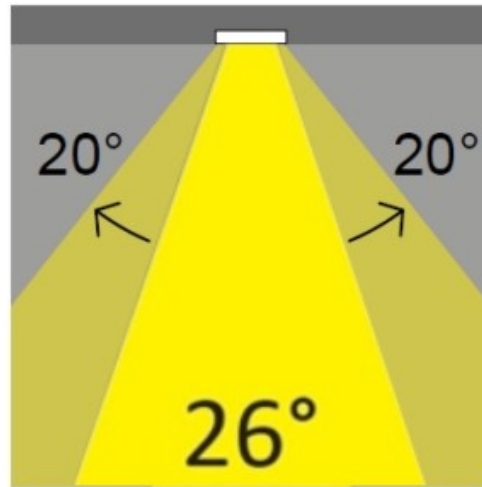

	DP	DV	
Dimming	Phase	0-10V	
Color Temperature	27K 2700K	30K 3000K	35K 3500K
		40K 4000K	

Order Example  **K°**
L5XXXXXX-DV-30K
 0-10V 3000K



PROJECT

TYPE

SPECIFIER

QUANTITY

DATE

Fixture Finish

Matte White - MWH

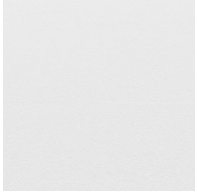

Digital: Not all screens are calibrated the same, and therefore, colors will appear differently between screens.

Physical: When texture is involved, there will be variations in color, character and tone within a product series and between product families.



PROJECT	
TYPE	
SPECIFIER	
QUANTITY	
DATE	

LEGEND

floor-mounted	pivotal	special LED (upon request) RGB, RGBW, tunable, gold+, meat+, art+, fashion+
wall and ceiling: recessed and surface mounted	rotating	warm dim / natural dimming LED
ceiling-mounted and wall-mounted	illuminate tilted	rechargeable battery powered
wall-mounted	color of suspension cable	fixture with natural vivid LED (upon request)
omni-directional light distribution	length of suspension cable	color rendering index
direct light distribution	reflector degree selection	color temperature
direct/indirect light distribution	super spot	lumen (luminous flux)
indirect light distribution	lens	efficacy (lumens per watt)
asymmetric light distribution	lens pack	Unified Glare Rating (UGR) range from 5-40
aura light distribution	shine ring	marine grade (AISI 316 stainless steel)
round wall or ceiling cut-out	integrated shine ring with diffuser	walk on
square wall or ceiling cut-out	free individual colors 01-29	drive on
the supplied jig specifies the cutout dimensions	individual colors: 00 (free of charge), 01-25 (extra charge)	Dark Sky Compliance
minimum distance (meters) lamp - object	luminaire part to be colored (F1)	Americans with Disabilities Act (less than 4" off the wall located between 27"-84" from floor)
recessed depth	luminaire part to be colored (F2)	lamp protected against explosion
ceiling thickness in mm	luminaire part to be colored (F3)	blown glass using traditional methods by master glass blower
ceiling thickness selection	luminaire part to be colored (F4)	acoustic material
dimmable DP (phase), DV (0-10V), DD (dali), DS (step-dim)	luminaire part to be colored (F5)	protection class I, protection insulation
included or excluded LED driver/transformer/control gear	color of 3-circuit adaptor	protection class II, protection insulation
separately switchable	indirect diffuser	ETL Certified to UL and CSA Standards
sensor	direct diffuser	UL Certified to UL and CSA Standards
remote control	ball-proof (upon request)	CSA Certified to UL and CSA Standards
available upon request	accessory	Certified for North American Standards

IP RATING

IP20	protected against ingress of solid bodies greater than 12.5mm (finger)
IP33	protected against ingress of solid bodies greater than 2.5mm protected against sprays of water up to 60 degrees from the vertical (rain)
IP40	protected against ingress of solid bodies greater than 1mm (wire) no protection against the ingress of moisture
IP43	protected against ingress of solid bodies greater than 1mm (wire) protected against sprays of water up to 60 degrees from the vertical (rain)
IP44	protected against ingress of solid bodies greater than 1mm (wire) protected against water splashed from all directions
IP54	protected against limited ingress of dust (wet rooms/covered outdoor areas) protected against water splashed from all directions
IP65	protected against ingress of dust protected against jets of water
IP66	protected against ingress of dust protected against powerful jets of water or heavy seas
IP67	protected against ingress of dust protected against immersion of water between 15cm - 1m for 30 minutes
IP68	protected against ingress of dust protected against immersion of water under pressure for long periods

IK RATING

IK01	protected against 0.14 joules impact (equivalent to 0.25kg mass dropped from 56mm above the surface)
IK02	protected against 0.2 joules impact (equivalent to 0.25kg mass dropped from 80mm above the surface)
IK03	protected against 0.35 joules impact (equivalent to 0.25kg mass dropped from 140mm above the surface)
IK04	protected against 0.5 joules impact (equivalent to 0.25kg mass dropped from 200mm above the surface)
IK05	protected against 0.7 joules impact (equivalent to 0.25kg mass dropped from 280mm above the surface)
IK06	protected against 1 joules impact (equivalent to 0.25kg mass dropped from 400mm above the surface)
IK07	protected against 2 joules impact (equivalent to 0.5kg mass dropped from 400mm above the surface)
IK08	protected against 5 joules impact (equivalent to 1.7kg mass dropped from 300mm above the surface)
IK09	protected against 10 joules impact (equivalent to 5.0kg mass dropped from 200mm above the surface)
IK10	protected against 20 joules impact (equivalent to 5.0kg mass dropped from 400mm above the surface)