

PROJECT _____
 TYPE _____
 SPECIFIER _____
 QUANTITY _____
 DATE _____

DRUM SUSPENSION

D111063-

base number _____
 Finish Options _____
 Finish Options _____

- To build a product code in our configurator select the specify button on the base model # product page
- To build a manual product code on this datasheet choose from the options listed below in blue font and add the suffix to the base model #

GENERAL

Series: Drum _____
 Brand: Ole _____
 Division: Design _____
 Mounting Type: Suspension _____
 Mounting Location: Ceiling _____
 Subcategory: Up/Down Light _____

PHYSICAL

Shape: Drum _____
 Diameter (mm): 600 _____
 Diameter (in): 23 ⁵/₈ _____
 Height (mm): 160 _____
 Height (in): 6 ³/₁₆ _____
 Max. Overall Height (mm): 2160 _____
 Max. Overall Height (in): 85 ¹/₁₆ _____
 Light Distribution: Direct / Indirect _____
 Weight (kg): 3.3 _____
 Weight (lbs): 7.26 _____
 Fixture Finish: BEI / BLK / BLU / COG / DGN / GRY / MRN / MOC / MUS / OLV / SIL / STN / TER / WHI _____
 Holder Finish: BLK _____
 Fixture Material: Fabric Cord / Metal _____
 Cable Details: 2000mm Cable _____
 Upon Request: Other fabric cord colors available upon request (see downloadable finish chart) _____

ELECTRICAL

Number of Lamps: 3 _____
 Lamp Type: LED Retrofit _____
 Lamp Shape: A19 _____
 Bulb Included: Bulb Not Included _____
 Max. Wattage Per Lamp (W): 15 _____
 Lamp Base: E26 _____
 Input Voltage (V): 120 _____
 Upon Request: 277Vac / GU24 _____

LED

OPTICAL

RATINGS AND CERTIFICATIONS

Certified By: Certified for North American Standards _____
 IP rating: IP20 _____

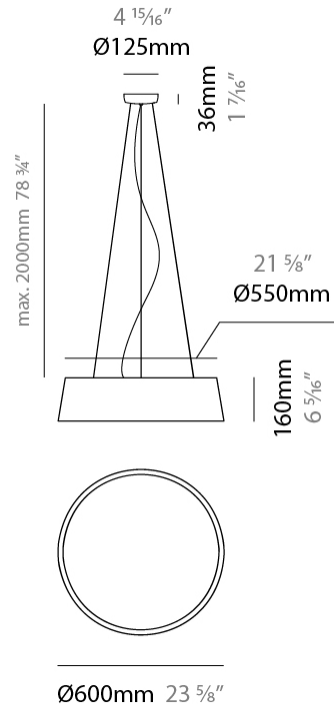

DRUM SUSPENSION

D111063-

PROJECT

TYPE

SPECIFIER

QUANTITY

DATE

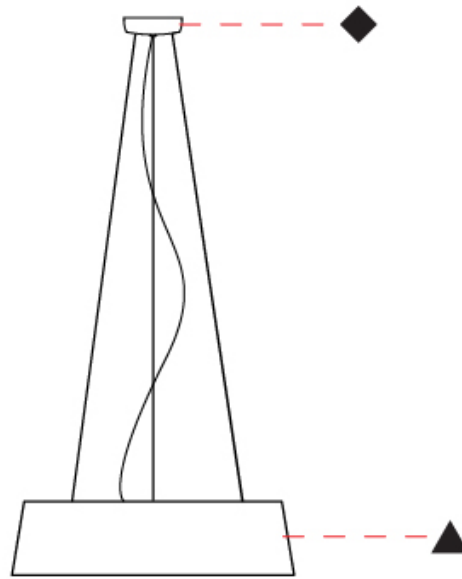

D

PROJECT
TYPE
SPECIFIER
QUANTITY
DATE

DRUM SURFACE

D112012-

base number Finish
Options

- To build a product code in our configurator select the specify button on the base model # product page
- To build a manual product code on this datasheet choose from the options listed below in blue font and add the suffix to the base model #

GENERAL

Series: Drum
 Brand: Ole
 Division: Design
 Mounting Type: Surface
 Mounting Location: Ceiling
 Subcategory: Ambient

PHYSICAL

Shape: Drum
 Diameter (mm): 500
 Diameter (in): 19 11/16
 Height (mm): 470
 Height (in): 18 1/2
 Light Distribution: Direct
 Weight (kg): 3.3
 Weight (lbs): 7.3
 Diffuser: PMMA - Opal
 Fixture Finish: BEI / BLK / BLU / COG / DGN / GRY / MRN / MOC / MUS / OL /V / SIL / STN / TER / WHI
 Holder Finish: BLK
 Fixture Material: Fabric Cord / Metal
 Upon Request: Other fabric cord colors available upon request (see downloadable finish chart)

ELECTRICAL

Number of Lamps: 3
 Lamp Type: LED Retrofit
 Lamp Shape: A19
 Bulb Included: Bulb Not Included
 Max. Wattage Per Lamp (W): 15
 Lamp Base: E26
 Input Voltage (V): 120
 Upon Request: 277Vac / GU24

LED

OPTICAL

RATINGS AND CERTIFICATIONS

Certified By: Certified for North American Standards
 IP rating: IP20

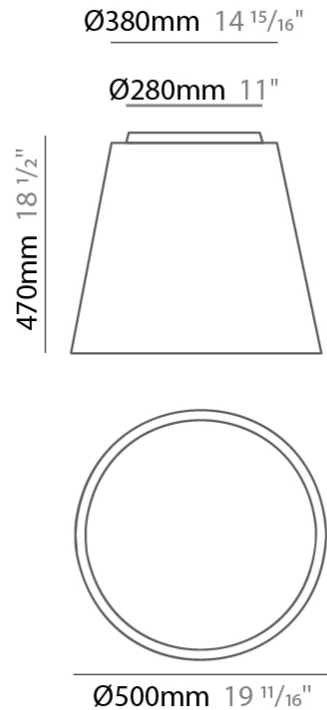

DRUM SURFACE

D112012-

PROJECT	_____
TYPE	_____
SPECIFIER	_____
QUANTITY	_____
DATE	_____

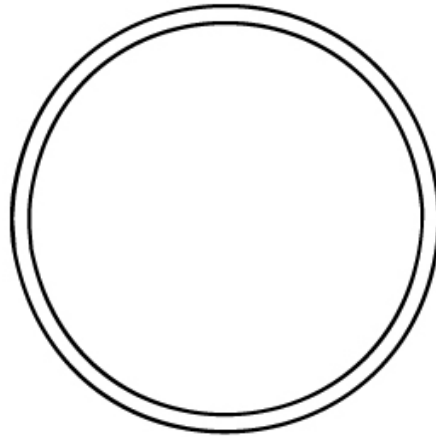
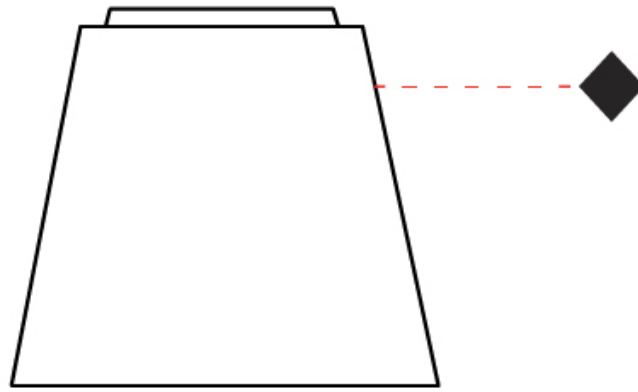

DRUM COLOR FINISH CHART

PROJECT	_____
TYPE	_____
SPECIFIER	_____
QUANTITY	_____
DATE	_____

Fixture Finish

Beige - BEI



Black - BLK



Blue - BLU



Cognac - COG



Dark Green - DGN



Gray - GRY



Maroon - MRN



Mocha - MOC



Mustard - MUS



Olive - OLV



Silver - SIL



Stone - STN



Terracotta - TER



White - WHI

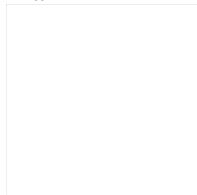

Holder Finish

Black - BLK

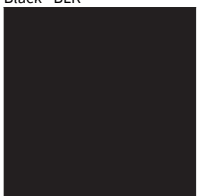

Digital: Not all screens are calibrated the same, and therefore, colors will appear differently between screens.

Physical: When texture is involved, there will be variations in color, character and tone within a product series and between product families.



PROJECT
TYPE
NOTES
QUANTITY
DATE

COLOR FINISH CHART



Digital: Not all screens are calibrated the same, and therefore, colors will appear differently between screens.
Physical: When texture is involved, there will be variations in color, character and tone within a product series and between product families.

COMPLETE COLOR FINISH CHART



Standard Colors with [S-]

Other fabric cord colors available upon request. Price increase and minimum quantities may apply

Digital: Not all screens are calibrated the same, and therefore, colors will appear differently between screens.

Physical: When texture is involved, there will be variations in color, character and tone within a product series and between product families.

Zaneen Group Inc. © 2024, T 1800-388-3382, F 416-247-9319, www.zaneen.com

Available for International specifications by adding 'INT' at the end of the existing Model #. For assistance on 'custom' specifications, contact zteam@zaneen.com.

In a constant effort to supply the best product, we reserve the right to change specifications or materials without notice. The most recent specification sheets are found at zaneen.com

COMPLETE COLOR FINISH CHART

JADE
Pant. 3268C 311



VERDE BILLAR
Pant. 340C 353



JUNGLA
Pant. 356C 310



VERDE OSC.
Pant. 3298C 358



MUSGO
Pant. 5535C 320



S - DARK GREEN
Pant. 5616C 301



S - OLIVE
Pant. 5625C 323



CIRUELA
Pant. 368C 104



LAVANDA
Pant. 374C 2214



CRUDO
Pant. 7401C 170



OPALE
Pant. 402 1442



S - STONE - STN
Pant. 7528C 1196



ASTRACAN
Pant. 7529C 101



CAMELLO
Pant. 731C 161



CASTANO
Pant. 4625C 1674



TABACO
Pant. 1545C 203



MARRON
Pant. 476C 187



MARRON SUPER
Pant. BLACK 4C 189



MADERA
Pant. 7519C 2183



S - MOCHA
Pant. 7504C 175



AVELLANA
Pant. 729C 152



S - BEIGE - BEI
Pant. 727C 196



ARENA
Pant. 465C 151



BEIGE / CAMEL
Pant. 1265C 154



Standard Colors with [S-]

Other fabric cord colors available upon request. Price increase and minimum quantities may apply

Digital: Not all screens are calibrated the same, and therefore, colors will appear differently between screens.

Physical: When texture is involved, there will be variations in color, character and tone within a product series and between product families.

Zaneen Group Inc. © 2024, T 1800-388-3382, F 416-247-9319, www.zaneen.com

Available for International specifications by adding 'INT' at the end of the existing Model #. For assistance on 'custom' specifications, contact zteam@zaneen.com.

In a constant effort to supply the best product, we reserve the right to change specifications or materials without notice. The most recent specification sheets are found at zaneen.com

COMPLETE COLOR FINISH CHART

ORO
Pant. 872C 16



GOLDEN
Pant. 7403C 7



S - MUSTARD
Pant. 1245C 168



CANARIO
Pant. 106C 9



MIMOSA
Pant. 108C 15



AMARILLO
Pant. 109U 1



NECTAR
Pant. 137C 1871



LAVA
Pant. 151C 1334



NARANJA
Pant. 164C 87



S - TERRACOTTA
Pant. 153C 205



CALABAZA
Pant. 158C 84



ARCILLA
Pant. 1675C 150



ROJO
Pant. 186C 241



FUEGO
Pant. 185C 245



SATAN
Pant. 207C 19



S - MAROON
Pant. 1955C 224



CLARETE
Pant. 209C 240



BURDEOS
Pant. 188C 163



RUBINA
Pant. 229C 285



FRESILLA
Pant. 695C 273



PURPURA
Pant. 215C 276



CICLAMOR
Pant. 205C 264



FUCSIA
Pant. 212C 267



PESCA
Pant. 218C 275



Standard Colors with [S-]

Other fabric cord colors available upon request. Price increase and minimum quantities may apply

Digital: Not all screens are calibrated the same, and therefore, colors will appear differently between screens.

Physical: When texture is involved, there will be variations in color, character and tone within a product series and between product families.

Zaneen Group Inc. © 2024, T 1800-388-3382, F 416-247-9319, www.zaneen.com

Available for International specifications by adding 'INT' at the end of the existing Model #. For assistance on 'custom' specifications, contact zteam@zaneen.com.

In a constant effort to supply the best product, we reserve the right to change specifications or materials without notice. The most recent specification sheets are found at zaneen.com

PROJECT _____
TYPE _____
NOTES _____
QUANTITY _____
DATE _____

COMPLETE COLOR FINISH CHART

ROSA PASTEL
Pant. 1905C 281



ALEJANDRIA
Pant. 196C 261



CANET
Pant. 2717C 43



MALVA
Pant. 2567C 141



AMORATADO
Pant. 265C 135



LAPIZLAZULI
Pant. 2745C 62



VIOLETA
Pant. 7676C 147



Standard Colors with [S-]

Other fabric cord colors available upon request. Price increase and minimum quantities may apply

Digital: Not all screens are calibrated the same, and therefore, colors will appear differently between screens.

Physical: When texture is involved, there will be variations in color, character and tone within a product series and between product families.

Zaneen Group Inc. © 2024, T 1800-388-3382, F 416-247-9319, www.zaneen.com

Available for International specifications by adding 'INT' at the end of the existing Model #. For assistance on 'custom' specifications, contact zteam@zaneen.com.

In a constant effort to supply the best product, we reserve the right to change specifications or materials without notice. The most recent specification sheets are found at zaneen.com

PROJECT	
TYPE	
SPECIFIER	
QUANTITY	
DATE	

LEGEND

floor-mounted	pivotal	special LED (upon request) RGB, RGBW, tunable, gold+, meat+, art+, fashion+
wall and ceiling: recessed and surface mounted	rotating	warm dim / natural dimming LED
ceiling-mounted and wall-mounted	illuminate tilted	rechargeable battery powered
wall-mounted	color of suspension cable	fixture with natural vivid LED (upon request)
omni-directional light distribution	length of suspension cable	color rendering index
direct light distribution	reflector degree selection	color temperature
direct/indirect light distribution	super spot	lumen (luminous flux)
indirect light distribution	lens	efficacy (lumens per watt)
asymmetric light distribution	lens pack	Unified Glare Rating (UGR) range from 5-40
aura light distribution	shine ring	marine grade (AISI 316 stainless steel)
round wall or ceiling cut-out	integrated shine ring with diffuser	walk on
square wall or ceiling cut-out	free individual colors 01-29	drive on
the supplied jig specifies the cutout dimensions	individual colors: 00 (free of charge), 01-25 (extra charge)	Dark Sky Compliance
minimum distance (meters) lamp - object	luminaire part to be colored (F1)	Americans with Disabilities Act (less than 4" off the wall located between 27"-84" from floor)
recessed depth	luminaire part to be colored (F2)	lamp protected against explosion
ceiling thickness in mm	luminaire part to be colored (F3)	blown glass using traditional methods by master glass blower
ceiling thickness selection	luminaire part to be colored (F4)	acoustic material
dimmable DP (phase), DV (0-10V), DD (dali), DS (step-dim)	luminaire part to be colored (F5)	protection class I, protection insulation
included or excluded LED driver/transformer/control gear	color of 3-circuit adaptor	protection class II, protection insulation
separately switchable	indirect diffuser	ETL Certified to UL and CSA Standards
sensor	direct diffuser	UL Certified to UL and CSA Standards
remote control	ball-proof (upon request)	CSA Certified to UL and CSA Standards
available upon request	accessory	Certified for North American Standards

IP RATING

IP20	protected against ingress of solid bodies greater than 12.5mm (finger)
IP33	protected against ingress of solid bodies greater than 2.5mm protected against sprays of water up to 60 degrees from the vertical (rain)
IP40	protected against ingress of solid bodies greater than 1mm (wire) no protection against the ingress of moisture
IP43	protected against ingress of solid bodies greater than 1mm (wire) protected against sprays of water up to 60 degrees from the vertical (rain)
IP44	protected against ingress of solid bodies greater than 1mm (wire) protected against water splashed from all directions
IP54	protected against limited ingress of dust (wet rooms/covered outdoor areas) protected against water splashed from all directions
IP65	protected against ingress of dust protected against jets of water
IP66	protected against ingress of dust protected against powerful jets of water or heavy seas
IP67	protected against ingress of dust protected against immersion of water between 15cm - 1m for 30 minutes
IP68	protected against ingress of dust protected against immersion of water under pressure for long periods

IK RATING

IK01	protected against 0.14 joules impact (equivalent to 0.25kg mass dropped from 56mm above the surface)
IK02	protected against 0.2 joules impact (equivalent to 0.25kg mass dropped from 80mm above the surface)
IK03	protected against 0.35 joules impact (equivalent to 0.25kg mass dropped from 140mm above the surface)
IK04	protected against 0.5 joules impact (equivalent to 0.25kg mass dropped from 200mm above the surface)
IK05	protected against 0.7 joules impact (equivalent to 0.25kg mass dropped from 280mm above the surface)
IK06	protected against 1 joules impact (equivalent to 0.25kg mass dropped from 400mm above the surface)
IK07	protected against 2 joules impact (equivalent to 0.5kg mass dropped from 400mm above the surface)
IK08	protected against 5 joules impact (equivalent to 1.7kg mass dropped from 300mm above the surface)
IK09	protected against 10 joules impact (equivalent to 5.0kg mass dropped from 200mm above the surface)
IK10	protected against 20 joules impact (equivalent to 5.0kg mass dropped from 400mm above the surface)