

PROJECT	
TYPE	
SPECIFIER	
QUANTITY	
DATE	

## DRUM SUSPENSION

### D111062-

base number	Finish Options	Finish Options
-------------	----------------	----------------

- To build a product code in our configurator select the specify button on the base model # product page
- To build a manual product code on this datasheet choose from the options listed below in blue font and add the suffix to the base model #

#### GENERAL

Series: Drum
Brand: Ole
Division: Design
Mounting Type: Suspension
Mounting Location: Ceiling
Subcategory: Up/Down Light

#### PHYSICAL

Shape: Drum
Diameter (mm): 500
Diameter (in): 19 11/16
Height (mm): 450
Height (in): 17 11/16
Max. Overall Height (mm): 2450
Max. Overall Height (in): 96 7/16
Light Distribution: Direct / Indirect
Weight (kg): 4
Weight (lbs): 8.8
Fixture Finish: BEI / BLK / BLU / COG / DGN / GRY / MRN / MOC / MUS / OLV / SIL / STN / TER / WHI
Holder Finish: BLK
Fixture Material: Fabric Cord / Metal
Cable Details: 2000mm Cable
Upon Request: Other fabric cord colors available upon request (see downloadable finish chart)

#### ELECTRICAL

Number of Lamps: 3
Lamp Type: LED Retrofit
Lamp Shape: A19
Bulb Included: Bulb Not Included
Max. Wattage Per Lamp (W): 15
Lamp Base: E26
Input Voltage (V): 120
Upon Request: 277Vac / GU24

#### LED

#### OPTICAL

#### RATINGS AND CERTIFICATIONS

Certified By: Certified for North American Standards
IP rating: IP20

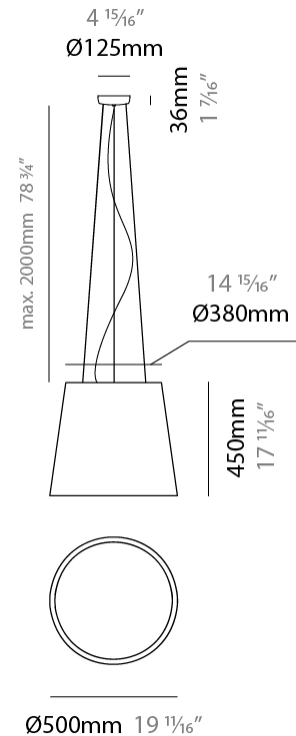

## DRUM SUSPENSION

D111062-

PROJECT

TYPE

SPECIFIER

QUANTITY

DATE

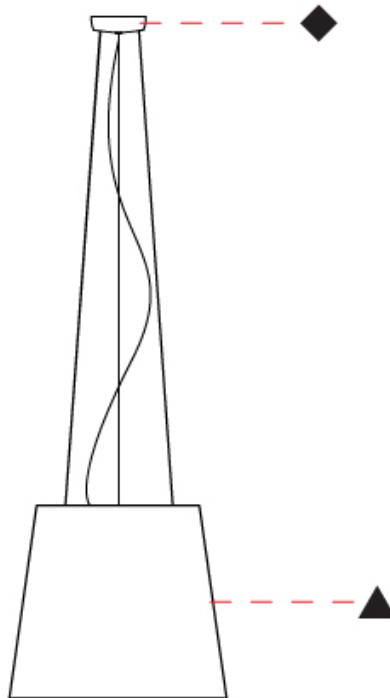

D

PROJECT \_\_\_\_\_  
 TYPE \_\_\_\_\_  
 SPECIFIER \_\_\_\_\_  
 QUANTITY \_\_\_\_\_  
 DATE \_\_\_\_\_

## DRUM SUSPENSION

### D111063-

base number \_\_\_\_\_  
 Finish Options \_\_\_\_\_  
 Finish Options \_\_\_\_\_

- To build a product code in our configurator select the specify button on the base model # product page
- To build a manual product code on this datasheet choose from the options listed below in blue font and add the suffix to the base model #

#### GENERAL

Series: Drum \_\_\_\_\_  
 Brand: Ole \_\_\_\_\_  
 Division: Design \_\_\_\_\_  
 Mounting Type: Suspension \_\_\_\_\_  
 Mounting Location: Ceiling \_\_\_\_\_  
 Subcategory: Up/Down Light \_\_\_\_\_

#### PHYSICAL

Shape: Drum \_\_\_\_\_  
 Diameter (mm): 600 \_\_\_\_\_  
 Diameter (in): 23 5/8 \_\_\_\_\_  
 Height (mm): 160 \_\_\_\_\_  
 Height (in): 6 3/16 \_\_\_\_\_  
 Max. Overall Height (mm): 2160 \_\_\_\_\_  
 Max. Overall Height (in): 85 1/16 \_\_\_\_\_  
 Light Distribution: Direct / Indirect \_\_\_\_\_  
 Weight (kg): 3.3 \_\_\_\_\_  
 Weight (lbs): 7.26 \_\_\_\_\_  
 Fixture Finish: BEI / BLK / BLU / COG / DGN / GRY / MRN / MOC / MUS / OLV / SIL / STN / TER / WHI \_\_\_\_\_  
 Holder Finish: BLK \_\_\_\_\_  
 Fixture Material: Fabric Cord / Metal \_\_\_\_\_  
 Cable Details: 2000mm Cable \_\_\_\_\_  
 Upon Request: Other fabric cord colors available upon request (see downloadable finish chart) \_\_\_\_\_

#### ELECTRICAL

Number of Lamps: 3 \_\_\_\_\_  
 Lamp Type: LED Retrofit \_\_\_\_\_  
 Lamp Shape: A19 \_\_\_\_\_  
 Bulb Included: Bulb Not Included \_\_\_\_\_  
 Max. Wattage Per Lamp (W): 15 \_\_\_\_\_  
 Lamp Base: E26 \_\_\_\_\_  
 Input Voltage (V): 120 \_\_\_\_\_  
 Upon Request: 277Vac / GU24 \_\_\_\_\_

#### LED

#### OPTICAL

#### RATINGS AND CERTIFICATIONS

Certified By: Certified for North American Standards \_\_\_\_\_  
 IP rating: IP20 \_\_\_\_\_

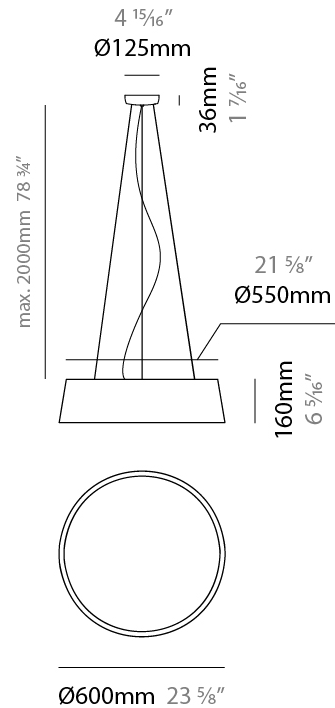

## DRUM SUSPENSION

D111063-

PROJECT

TYPE

SPECIFIER

QUANTITY

DATE

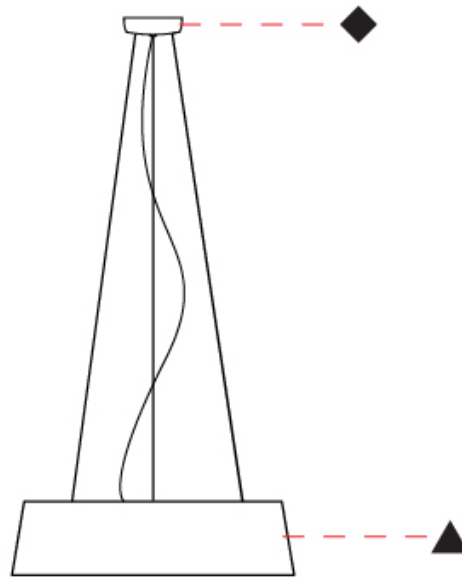

D

PROJECT
TYPE
SPECIFIER
QUANTITY
DATE

## DRUM SURFACE

### D112012-

base number Finish  
Options

- To build a product code in our configurator select the specify button on the base model # product page
- To build a manual product code on this datasheet choose from the options listed below in blue font and add the suffix to the base model #

#### GENERAL

Series: Drum  
 Brand: Ole  
 Division: Design  
 Mounting Type: Surface  
 Mounting Location: Ceiling  
 Subcategory: Ambient

#### PHYSICAL

Shape: Drum  
 Diameter (mm): 500  
 Diameter (in): 19 11/16  
 Height (mm): 470  
 Height (in): 18 1/2  
 Light Distribution: Direct  
 Weight (kg): 3.3  
 Weight (lbs): 7.3  
 Diffuser: PMMA - Opal  
 Fixture Finish: BEI / BLK / BLU / COG / DGN / GRY / MRN / MOC / MUS / OLV / SIL / STN / TER / WHI  
 Holder Finish: BLK  
 Fixture Material: Fabric Cord / Metal  
 Upon Request: Other fabric cord colors available upon request (see downloadable finish chart)

#### ELECTRICAL

Number of Lamps: 3  
 Lamp Type: LED Retrofit  
 Lamp Shape: A19  
 Bulb Included: Bulb Not Included  
 Max. Wattage Per Lamp (W): 15  
 Lamp Base: E26  
 Input Voltage (V): 120  
 Upon Request: 277Vac / GU24

#### LED

#### OPTICAL

#### RATINGS AND CERTIFICATIONS

Certified By: Certified for North American Standards  
 IP rating: IP20

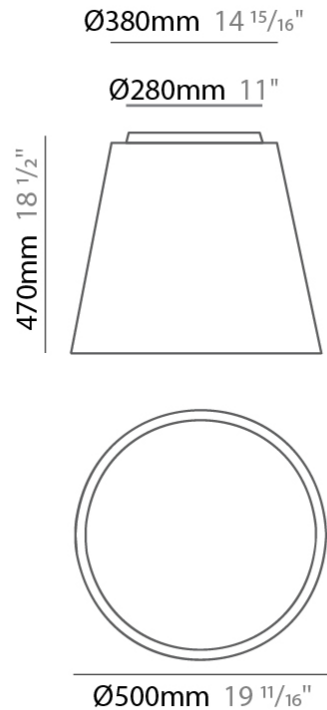

## DRUM SURFACE

D112012-

PROJECT	_____
TYPE	_____
SPECIFIER	_____
QUANTITY	_____
DATE	_____

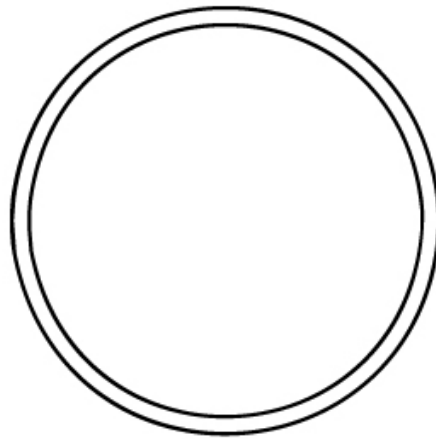
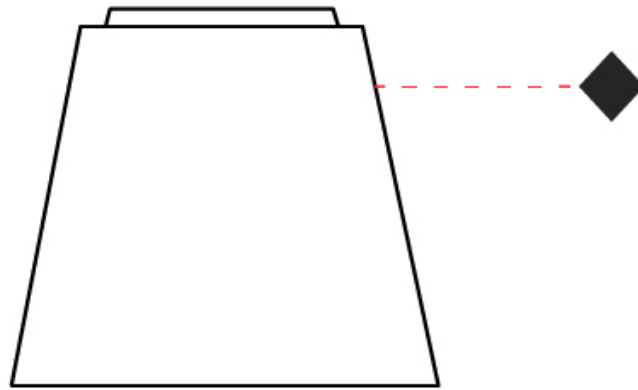

PROJECT
TYPE
SPECIFIER
QUANTITY
DATE

## DRUM SURFACE

### D112013-

base number Finish  
Options

- To build a product code in our configurator select the specify button on the base model # product page
- To build a manual product code on this datasheet choose from the options listed below in blue font and add the suffix to the base model #

#### GENERAL

Series: Drum  
 Brand: Ole  
 Division: Design  
 Mounting Type: Surface  
 Mounting Location: Ceiling  
 Subcategory: Ambient

#### PHYSICAL

Shape: Drum  
 Diameter (mm): 600  
 Diameter (in): 23 <sup>5</sup>/<sub>8</sub>  
 Height (mm): 180  
 Height (in): 7 <sup>1</sup>/<sub>16</sub>  
 Light Distribution: Direct  
 Weight (kg): 3  
 Weight (lbs): 6.6  
 Diffuser: PMMA - Opal  
 Fixture Finish: BEI / BLK / BLU / COG / DGN / GRY / MRN / MOC / MUS / OLV / SIL / STN / TER / WHI  
 Holder Finish: BLK  
 Fixture Material: Fabric Cord / Metal  
 Upon Request: Other fabric cord colors available upon request (see downloadable finish chart)

#### ELECTRICAL

Number of Lamps: 3  
 Lamp Type: LED Retrofit  
 Lamp Shape: A19  
 Bulb Included: Bulb Not Included  
 Max. Wattage Per Lamp (W): 15  
 Lamp Base: E26  
 Input Voltage (V): 120  
 Upon Request: 277Vac / GU24

#### LED

#### OPTICAL

#### RATINGS AND CERTIFICATIONS

Certified By: Certified for North American Standards  
 IP rating: IP20

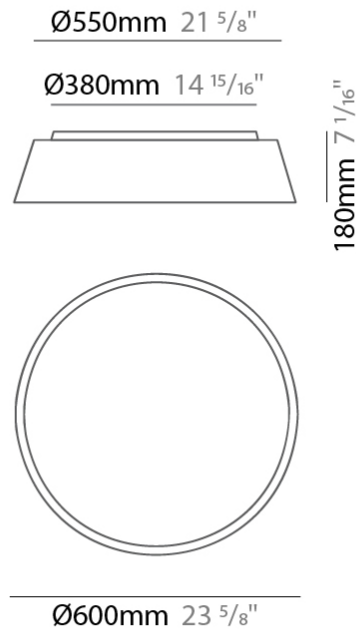

## DRUM SURFACE

D112013-

PROJECT

TYPE

SPECIFIER

QUANTITY

DATE

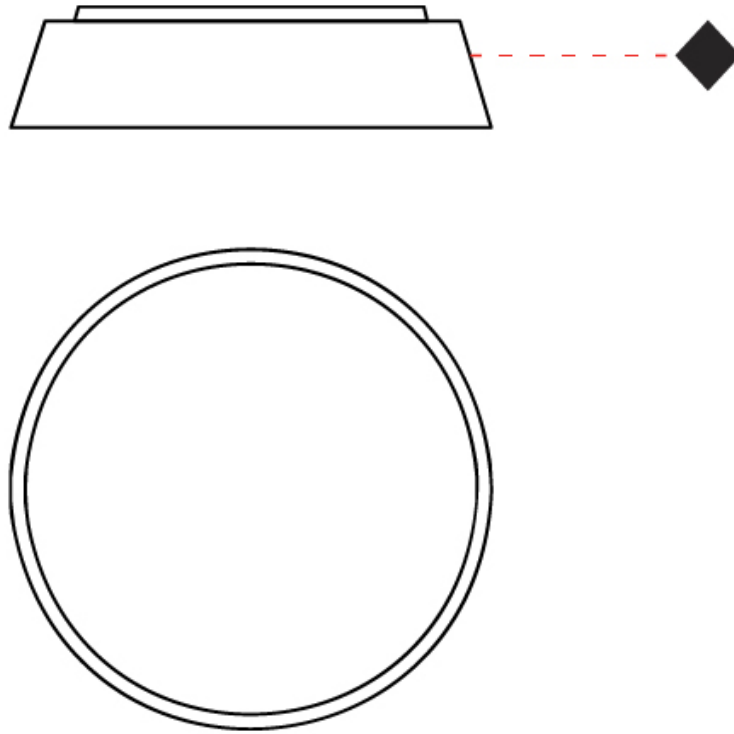



## DRUM COLOR FINISH CHART

PROJECT	_____
TYPE	_____
SPECIFIER	_____
QUANTITY	_____
DATE	_____

### Fixture Finish

Beige - BEI



Black - BLK



Blue - BLU



Cognac - COG



Dark Green - DGN



Gray - GRY

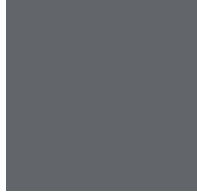

Maroon - MRN



Mocha - MOC



Mustard - MUS



Olive - OLV



Silver - SIL



Stone - STN



Terracotta - TER



White - WHI

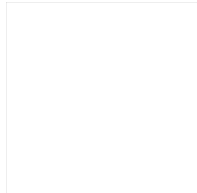

### Holder Finish

Black - BLK



**Digital:** Not all screens are calibrated the same, and therefore, colors will appear differently between screens.

**Physical:** When texture is involved, there will be variations in color, character and tone within a product series and between product families.



## COLOR FINISH CHART

BEIGE - BEI  
Pant. 727C 196



BLACK - BLK  
Pant. BLACK C 211



BLUE - BLU  
Pant. 653C 61



COGNAC - COG  
Pant. BLACK C 255



DARK GREEN - DGN  
Pant. 5616C 301



GRAY - GRY  
Pant. 10C 120



MAROON - MRN  
Pant. 1955C 224



MOCHA - MOC  
Pant. 7504C 175



MUSTARD - MUS  
Pant. 1245C 168



OLIVE - OLV  
Pant. 5625C 323



SILVER - SIL  
Pant. 7C 129



STONE - STN  
Pant. 7528C 1196



TERRACOTTA - TER  
Pant. 153C 205



WHITE - WHI  
Pant. WHITE 71



**Digital:** Not all screens are calibrated the same, and therefore, colors will appear differently between screens.

**Physical:** When texture is involved, there will be variations in color, character and tone within a product series and between product families.

## COMPLETE COLOR FINISH CHART



Standard Colors with [S-]

Other fabric cord colors available upon request. Price increase and minimum quantities may apply

**Digital:** Not all screens are calibrated the same, and therefore, colors will appear differently between screens.

**Physical:** When texture is involved, there will be variations in color, character and tone within a product series and between product families.

Zaneen Group Inc. © 2024, T 1800-388-3382, F 416-247-9319, www.zaneen.com

Available for International specifications by adding 'INT' at the end of the existing Model #. For assistance on 'custom' specifications, contact zteam@zaneen.com.

In a constant effort to supply the best product, we reserve the right to change specifications or materials without notice. The most recent specification sheets are found at zaneen.com

## COMPLETE COLOR FINISH CHART

JADE  
Pant. 3268C 311



VERDE BILLAR  
Pant. 340C 353



JUNGLA  
Pant. 356C 310



VERDE OSC.  
Pant. 3298C 358



MUSGO  
Pant. 5535C 320



S - DARK GREEN  
Pant. 5616C 301



S - OLIVE  
Pant. 5625C 323



CIRUELA  
Pant. 368C 104



LAVANDA  
Pant. 374C 2214



CRUDO  
Pant. 7401C 170



OPALE  
Pant. 402 1442



S - STONE - STN  
Pant. 7528C 1196



ASTRACAN  
Pant. 7529C 101



CAMELLO  
Pant. 731C 161



CASTANO  
Pant. 4625C 1674



TABACO  
Pant. 1545C 203



MARRON  
Pant. 476C 187



MARRON SUPER  
Pant. BLACK 4C 189



MADERA  
Pant. 7519C 2183



S - MOCHA  
Pant. 7504C 175



AVELLANA  
Pant. 729C 152



S - BEIGE - BEI  
Pant. 727C 196



ARENA  
Pant. 465C 151



BEIGE / CAMEL  
Pant. 1265C 154



Standard Colors with [S-]

Other fabric cord colors available upon request. Price increase and minimum quantities may apply

**Digital:** Not all screens are calibrated the same, and therefore, colors will appear differently between screens.

**Physical:** When texture is involved, there will be variations in color, character and tone within a product series and between product families.

Zaneen Group Inc. © 2024, T 1800-388-3382, F 416-247-9319, www.zaneen.com

Available for International specifications by adding 'INT' at the end of the existing Model #. For assistance on 'custom' specifications, contact zteam@zaneen.com.

In a constant effort to supply the best product, we reserve the right to change specifications or materials without notice. The most recent specification sheets are found at zaneen.com

## COMPLETE COLOR FINISH CHART



Standard Colors with [S-]

Other fabric cord colors available upon request. Price increase and minimum quantities may apply

**Digital:** Not all screens are calibrated the same, and therefore, colors will appear differently between screens.

**Physical:** When texture is involved, there will be variations in color, character and tone within a product series and between product families.

Zaneen Group Inc. © 2024, T 1800-388-3382, F 416-247-9319, [www.zaneen.com](http://www.zaneen.com)

Available for International specifications by adding 'INT' at the end of the existing Model #. For assistance on 'custom' specifications, contact [zteam@zaneen.com](mailto:zteam@zaneen.com).

In a constant effort to supply the best product, we reserve the right to change specifications or materials without notice. The most recent specification sheets are found at [zaneen.com](http://zaneen.com)

PROJECT \_\_\_\_\_  
 TYPE \_\_\_\_\_  
 NOTES \_\_\_\_\_  
 QUANTITY \_\_\_\_\_  
 DATE \_\_\_\_\_

## COMPLETE COLOR FINISH CHART

ROSA PASTEL  
 Pant. 1905C 281



ALEJANDRIA  
 Pant. 196C 261



CANET  
 Pant. 2717C 43



MALVA  
 Pant. 2567C 141



AMORATADO  
 Pant. 265C 135



LAPIZLAZULI  
 Pant. 2745C 62



VIOLETA  
 Pant. 7676C 147



Standard Colors with [S-]

Other fabric cord colors available upon request. Price increase and minimum quantities may apply

**Digital:** Not all screens are calibrated the same, and therefore, colors will appear differently between screens.

**Physical:** When texture is involved, there will be variations in color, character and tone within a product series and between product families.

Zaneen Group Inc. © 2024, T 1800-388-3382, F 416-247-9319, www.zaneen.com











Available for International specifications by adding 'INT' at the end of the existing Model #. For assistance on 'custom' specifications, contact zteam@zaneen.com.

In a constant effort to supply the best product, we reserve the right to change specifications or materials without notice. The most recent specification sheets are found at zaneen.com

### LEGEND

 floor-mounted	 pivotable	 special LED (upon request) RGB, RGBW, tunable, gold+, meat+, art+, fashion+
 wall and ceiling: recessed and surface mounted	 rotating	 warm dim / natural dimming LED
 ceiling-mounted and wall-mounted	 illuminate tilted	 rechargeable battery powered
 wall-mounted	 color of suspension cable	 fixture with natural vivid LED (upon request)
 omni-directional light distribution	 length of suspension cable	 color rendering index
 direct light distribution	 reflector degree selection	 color temperature
 direct/indirect light distribution	 super spot	 lumen (luminous flux)
 indirect light distribution	 lens	 efficacy (lumens per watt)
 asymmetric light distribution	 lens pack	 Unified Glare Rating (UGR) range from 5-40
 aura light distribution	 shine ring	 marine grade (AISI 316 stainless steel)
 round wall or ceiling cut-out	 integrated shine ring with diffuser	 walk on
 square wall or ceiling cut-out	 free individual colors 01-29	 drive on
 the supplied jig specifies the cutout dimensions	 individual colors: 00 (free of charge), 01-25 (extra charge)	 Dark Sky Compliance
 minimum distance (meters) lamp - object	 luminaire part to be colored (F1)	 Americans with Disabilities Act (less than 4" off the wall located between 27"-84" from floor)
 recessed depth	 luminaire part to be colored (F2)	 lamp protected against explosion
 ceiling thickness in mm	 luminaire part to be colored (F3)	 blown glass using traditional methods by master glass blower
 ceiling thickness selection	 luminaire part to be colored (F4)	 acoustic material
 dimmable DP (phase), DV (0-10V), DD (dali), DS (step-dim)	 luminaire part to be colored (F5)	 protection class I, protection insulation
 included or excluded LED driver/transformer/control gear	 color of 3-circuit adaptor	 protection class II, protection insulation
 separately switchable	 indirect diffuser	 ETL Certified to UL and CSA Standards
 sensor	 direct diffuser	 UL Certified to UL and CSA Standards
 remote control	 ball-proof (upon request)	 CSA Certified to UL and CSA Standards
 available upon request	 accessory	 Certified for North American Standards

### IP RATING

 IP20	protected against ingress of solid bodies greater than 12.5mm (finger)
 IP33	protected against ingress of solid bodies greater than 2.5mm protected against sprays of water up to 60 degrees from the vertical (rain)
 IP40	protected against ingress of solid bodies greater than 1mm (wire) no protection against the ingress of moisture
 IP43	protected against ingress of solid bodies greater than 1mm (wire) protected against sprays of water up to 60 degrees from the vertical (rain)
 IP44	protected against ingress of solid bodies greater than 1mm (wire) protected against water splashed from all directions
 IP54	protected against limited ingress of dust (wet rooms/covered outdoor areas) protected against water splashed from all directions
 IP65	protected against ingress of dust protected against jets of water
 IP66	protected against ingress of dust protected against powerful jets of water or heavy seas
 IP67	protected against ingress of dust protected against immersion of water between 15cm - 1m for 30 minutes
 IP68	protected against ingress of dust protected against immersion of water under pressure for long periods

### IK RATING

 IK01	protected against 0.14 joules impact (equivalent to 0.25kg mass dropped from 56mm above the surface)
 IK02	protected against 0.2 joules impact (equivalent to 0.25kg mass dropped from 80mm above the surface)
 IK03	protected against 0.35 joules impact (equivalent to 0.25kg mass dropped from 140mm above the surface)
 IK04	protected against 0.5 joules impact (equivalent to 0.25kg mass dropped from 200mm above the surface)
 IK05	protected against 0.7 joules impact (equivalent to 0.25kg mass dropped from 280mm above the surface)
 IK06	protected against 1 joules impact (equivalent to 0.25kg mass dropped from 400mm above the surface)
 IK07	protected against 2 joules impact (equivalent to 0.5kg mass dropped from 400mm above the surface)
 IK08	protected against 5 joules impact (equivalent to 1.7kg mass dropped from 300mm above the surface)
 IK09	protected against 10 joules impact (equivalent to 5.0kg mass dropped from 200mm above the surface)
 IK10	protected against 20 joules impact (equivalent to 5.0kg mass dropped from 400mm above the surface)