

## DRUM SUSPENSION

### D111058-

base number      Finish Options      Finish Options

- To build a product code in our configurator select the specify button on the base model # product page
- To build a manual product code on this datasheet choose from the options listed below in blue font and add the suffix to the base model #

#### GENERAL

Series: Drum  
 Brand: Ole  
 Division: Design  
 Mounting Type: Suspension  
 Mounting Location: Ceiling  
 Subcategory: Up/Down Light

#### PHYSICAL

Shape: Drum  
 Diameter (mm): 300  
 Diameter (in): 11 <sup>13</sup>/<sub>16</sub>"  
 Height (mm): 200  
 Height (in): 7 <sup>7</sup>/<sub>8</sub>"  
 Max. Overall Height (mm): 2200  
 Max. Overall Height (in): 86 <sup>5</sup>/<sub>8</sub>"  
 Light Distribution: Direct / Indirect  
 Weight (kg): 2  
 Weight (lbs): 4.4  
 Fixture Finish: BEI / BLK / BLU / COG / DGN / GRY / MRN / MOC / MUS / OLV / SIL / STN / TER / WHI  
 Holder Finish: BLK  
 Fixture Material: Fabric Cord / Metal  
 Cable Details: 2000mm Cable  
 Upon Request: Other fabric cord colors available upon request (see downloadable finish chart)

#### ELECTRICAL

Number of Lamps: 1  
 Lamp Type: LED Retrofit  
 Lamp Shape: A19  
 Bulb Included: Bulb Not Included  
 Max. Wattage Per Lamp (W): 15  
 Lamp Base: E26  
 Input Voltage (V): 120  
 Upon Request: 277Vac / GU24

#### LED

#### OPTICAL

#### RATINGS AND CERTIFICATIONS

Certified By: Certified for North American Standards  
 IP rating: IP20

PROJECT
TYPE
SPECIFIER
QUANTITY
DATE

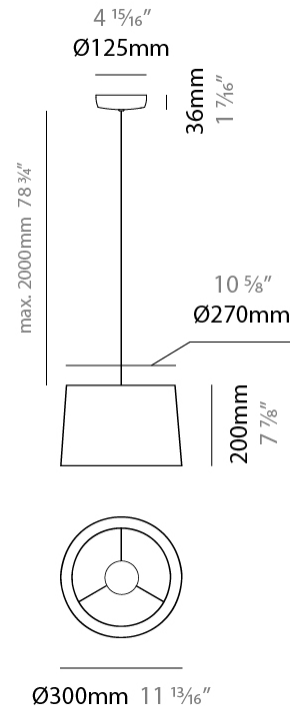

## DRUM SUSPENSION

D111058-

PROJECT

TYPE

SPECIFIER

QUANTITY

DATE

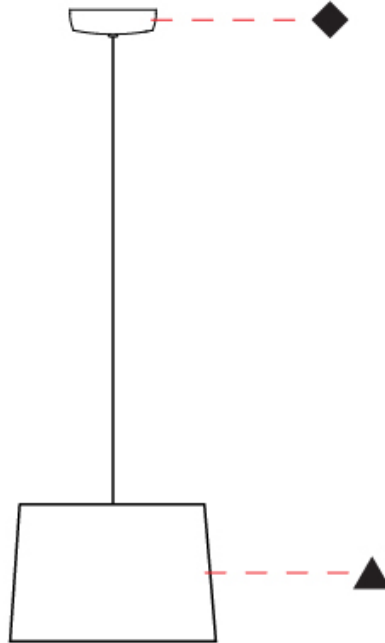

D

PROJECT \_\_\_\_\_  
 TYPE \_\_\_\_\_  
 SPECIFIER \_\_\_\_\_  
 QUANTITY \_\_\_\_\_  
 DATE \_\_\_\_\_

## DRUM PORTABLE

### D114008-

base number \_\_\_\_\_  
 Finish \_\_\_\_\_  
 Options \_\_\_\_\_

- To build a product code in our configurator select the specify button on the base model # product page
- To build a manual product code on this datasheet choose from the options listed below in blue font and add the suffix to the base model #

#### GENERAL

Series: Drum \_\_\_\_\_  
 Brand: Ole \_\_\_\_\_  
 Division: Design \_\_\_\_\_  
 Mounting Type: Portable \_\_\_\_\_  
 Mounting Location: Table \_\_\_\_\_  
 Subcategory: Ambient \_\_\_\_\_

#### PHYSICAL

Shape: Drum \_\_\_\_\_  
 Diameter (mm): 300 \_\_\_\_\_  
 Diameter (in): 11 <sup>13</sup>/<sub>16</sub> \_\_\_\_\_  
 Height (mm): 490 \_\_\_\_\_  
 Height (in): 19 <sup>5</sup>/<sub>16</sub> \_\_\_\_\_  
 Light Distribution: Direct / Indirect \_\_\_\_\_  
 Weight (kg): 1.7 \_\_\_\_\_  
 Weight (lbs): 3.7 \_\_\_\_\_  
 Diffuser: Cord Shade - Beige / Black / Blue / Brown / Dark Green / Green / Gray / Lithium / Maroon / Marsala / Red / Silver / Stone / White \_\_\_\_\_  
 Fixture Finish: [GWT](#) \_\_\_\_\_  
 Fixture Material: Fabric Cord / Metal \_\_\_\_\_

#### ELECTRICAL

Number of Lamps: 1 \_\_\_\_\_  
 Lamp Type: LED Retrofit \_\_\_\_\_  
 Lamp Shape: A19 \_\_\_\_\_  
 Bulb Included: Bulb Not Included \_\_\_\_\_  
 Max. Wattage Per Lamp (W): 15 \_\_\_\_\_  
 Lamp Base: E26 \_\_\_\_\_  
 Input Voltage (V): 120 \_\_\_\_\_  
 Upon Request: 277Vac / GU24 \_\_\_\_\_

#### LED

#### OPTICAL

#### RATINGS AND CERTIFICATIONS

Certified By: Certified for North American Standards \_\_\_\_\_  
 IP rating: IP20 \_\_\_\_\_

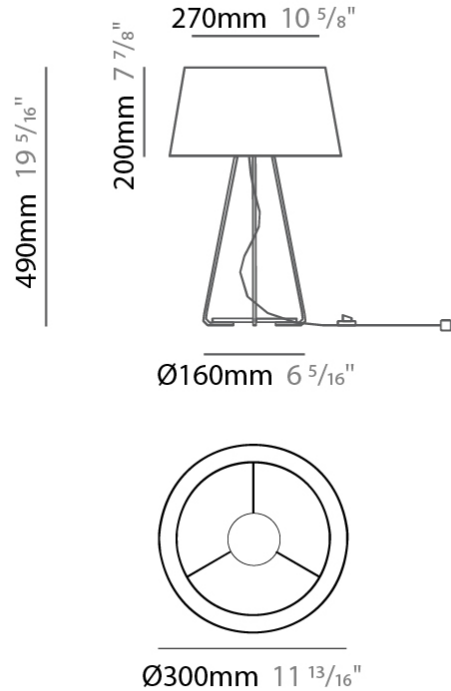

## DRUM PORTABLE

D114008-

PROJECT

TYPE

SPECIFIER

QUANTITY

DATE

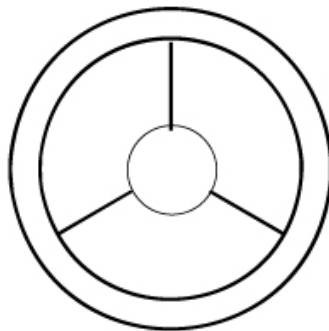
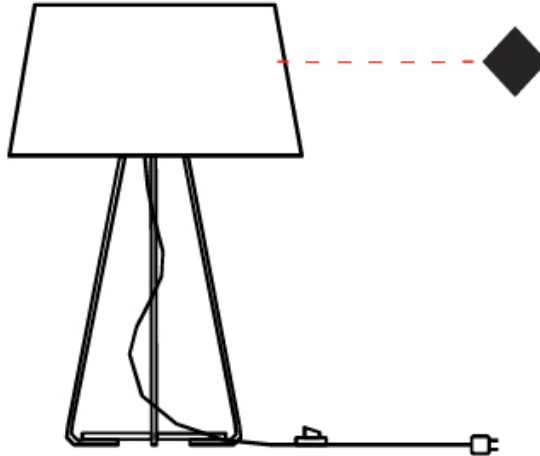

D

PROJECT \_\_\_\_\_  
 TYPE \_\_\_\_\_  
 SPECIFIER \_\_\_\_\_  
 QUANTITY \_\_\_\_\_  
 DATE \_\_\_\_\_

## DRUM PORTABLE

### D114010-

base number \_\_\_\_\_  
 Finish \_\_\_\_\_  
 Options \_\_\_\_\_

- To build a product code in our configurator select the specify button on the base model # product page
- To build a manual product code on this datasheet choose from the options listed below in blue font and add the suffix to the base model #

#### GENERAL

Series: Drum \_\_\_\_\_  
 Brand: Ole \_\_\_\_\_  
 Division: Design \_\_\_\_\_  
 Mounting Type: Portable \_\_\_\_\_  
 Mounting Location: Table \_\_\_\_\_  
 Subcategory: Ambient \_\_\_\_\_

#### PHYSICAL

Shape: Drum \_\_\_\_\_  
 Diameter (mm): 300 \_\_\_\_\_  
 Diameter (in): 11 <sup>13</sup>/<sub>16</sub> \_\_\_\_\_  
 Height (mm): 340 \_\_\_\_\_  
 Height (in): 13 <sup>3</sup>/<sub>8</sub> \_\_\_\_\_  
 Light Distribution: Direct / Indirect \_\_\_\_\_  
 Weight (kg): 1.7 \_\_\_\_\_  
 Weight (lbs): 3.7 \_\_\_\_\_  
 Diffuser: Cord Shade - Beige / Black / Blue / Brown / Dark Green / Green / Gray / Lithium / Maroon / Marsala / Red / Silver / Stone / White \_\_\_\_\_  
 Fixture Finish: GWT \_\_\_\_\_  
 Fixture Material: Fabric Cord / Metal \_\_\_\_\_

#### ELECTRICAL

Number of Lamps: 1 \_\_\_\_\_  
 Lamp Type: LED Retrofit \_\_\_\_\_  
 Lamp Shape: A19 \_\_\_\_\_  
 Bulb Included: Bulb Not Included \_\_\_\_\_  
 Max. Wattage Per Lamp (W): 15 \_\_\_\_\_  
 Lamp Base: E26 \_\_\_\_\_  
 Input Voltage (V): 120 \_\_\_\_\_  
 Upon Request: 277Vac / GU24 \_\_\_\_\_

#### LED

#### OPTICAL

#### RATINGS AND CERTIFICATIONS

Certified By: Certified for North American Standards \_\_\_\_\_  
 IP rating: IP20 \_\_\_\_\_

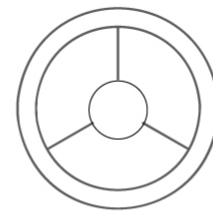
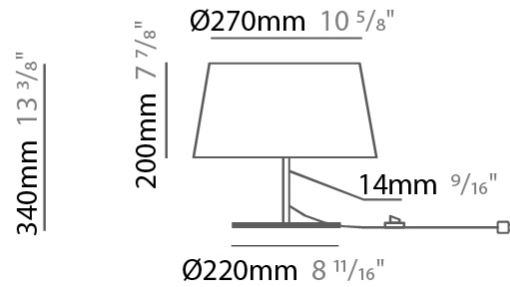

Ø300mm 11 <sup>13</sup>/<sub>16</sub>"



## DRUM PORTABLE

D114010-

PROJECT

TYPE

SPECIFIER

QUANTITY

DATE

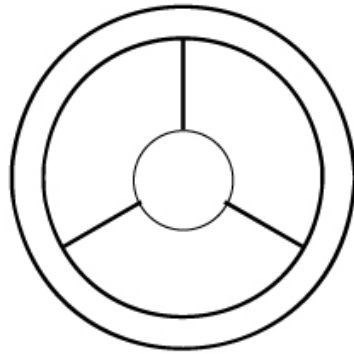
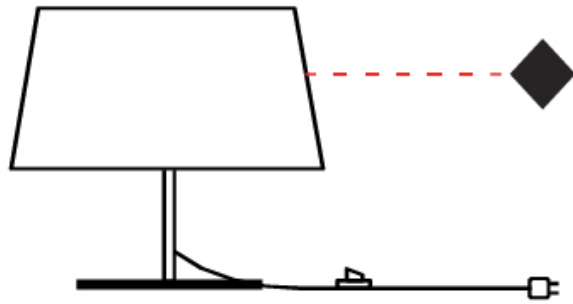

D

## DRUM

### COLOR FINISH CHART

PROJECT \_\_\_\_\_

TYPE \_\_\_\_\_

SPECIFIER \_\_\_\_\_

QUANTITY \_\_\_\_\_

DATE \_\_\_\_\_

#### Fixture Finish

Beige - BEI



Black - BLK



Blue - BLU



Cognac - COG



Dark Green - DGN



Gray - GRY

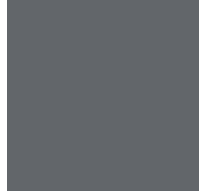

Maroon - MRN



Mocha - MOC



Mustard - MUS



Olive - OLV



Silver - SIL



Stone - STN



Terracotta - TER



White - WHI

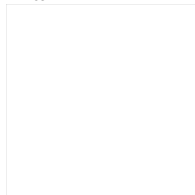

Granulated White - GWT

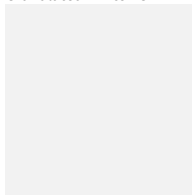

#### Holder Finish

Black - BLK

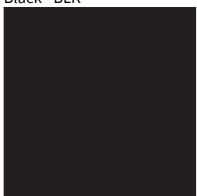

**Digital:** Not all screens are calibrated the same, and therefore, colors will appear differently between screens.

**Physical:** When texture is involved, there will be variations in color, character and tone within a product series and between product families.



## COLOR FINISH CHART

BEIGE - BEI  
Pant. 727C 196



BLACK - BLK  
Pant. BLACK C 211



BLUE - BLU  
Pant. 653C 61



COGNAC - COG  
Pant. BLACK C 255



DARK GREEN - DGN  
Pant. 5616C 301



GRAY - GRY  
Pant. 10C 120



MAROON - MRN  
Pant. 1955C 224



MOCHA - MOC  
Pant. 7504C 175



MUSTARD - MUS  
Pant. 1245C 168



OLIVE - OLV  
Pant. 5625C 323



SILVER - SIL  
Pant. 7C 129



STONE - STN  
Pant. 7528C 1196



TERRACOTTA - TER  
Pant. 153C 205



WHITE - WHI  
Pant. WHITE 71



**Digital:** Not all screens are calibrated the same, and therefore, colors will appear differently between screens.

**Physical:** When texture is involved, there will be variations in color, character and tone within a product series and between product families.



## COMPLETE COLOR FINISH CHART



Standard Colors with [S-]

Other fabric cord colors available upon request. Price increase and minimum quantities may apply

**Digital:** Not all screens are calibrated the same, and therefore, colors will appear differently between screens.

**Physical:** When texture is involved, there will be variations in color, character and tone within a product series and between product families.

Zaneen Group Inc. © 2024, T 1800-388-3382, F 416-247-9319, www.zaneen.com

Available for International specifications by adding 'INT' at the end of the existing Model #. For assistance on 'custom' specifications, contact zteam@zaneen.com.

In a constant effort to supply the best product, we reserve the right to change specifications or materials without notice. The most recent specification sheets are found at zaneen.com

## COMPLETE COLOR FINISH CHART

JADE  
 Pant. 3268C 311



VERDE BILLAR  
 Pant. 340C 353



JUNGLA  
 Pant. 356C 310



VERDE OSC.  
 Pant. 3298C 358



MUSGO  
 Pant. 5535C 320



S - DARK GREEN  
 Pant. 5616C 301



S - OLIVE  
 Pant. 5625C 323



CIRUELA  
 Pant. 368C 104



LAVANDA  
 Pant. 374C 2214



CRUDO  
 Pant. 7401C 170



OPALE  
 Pant. 402 1442



S - STONE - STN  
 Pant. 7528C 1196



ASTRACAN  
 Pant. 7529C 101



CAMELLO  
 Pant. 731C 161



CASTANO  
 Pant. 4625C 1674



TABACO  
 Pant. 1545C 203



MARRON  
 Pant. 476C 187



MARRON SUPER  
 Pant. BLACK 4C 189



MADERA  
 Pant. 7519C 2183



S - MOCHA  
 Pant. 7504C 175



AVELLANA  
 Pant. 729C 152



S - BEIGE - BEI  
 Pant. 727C 196



ARENA  
 Pant. 465C 151



BEIGE / CAMEL  
 Pant. 1265C 154



Standard Colors with [S-]

Other fabric cord colors available upon request. Price increase and minimum quantities may apply

**Digital:** Not all screens are calibrated the same, and therefore, colors will appear differently between screens.

**Physical:** When texture is involved, there will be variations in color, character and tone within a product series and between product families.

Zaneen Group Inc. © 2024, T 1800-388-3382, F 416-247-9319, www.zaneen.com

Available for International specifications by adding 'INT' at the end of the existing Model #. For assistance on 'custom' specifications, contact zteam@zaneen.com.

In a constant effort to supply the best product, we reserve the right to change specifications or materials without notice. The most recent specification sheets are found at zaneen.com

## COMPLETE COLOR FINISH CHART

ORO  
Pant. 872C 16



GOLDEN  
Pant. 7403C 7



S - MUSTARD  
Pant. 1245C 168



CANARIO  
Pant. 106C 9



MIMOSA  
Pant. 108C 15



AMARILLO  
Pant. 109U 1



NECTAR  
Pant. 137C 1871



LAVA  
Pant. 151C 1334



NARANJA  
Pant. 164C 87



S - TERRACOTTA  
Pant. 153C 205



CALABAZA  
Pant. 158C 84



ARCILLA  
Pant. 1675C 150



ROJO  
Pant. 186C 241



FUEGO  
Pant. 185C 245



SATAN  
Pant. 207C 19



S - MAROON  
Pant. 1955C 224



CLARETE  
Pant. 209C 240



BURDEOS  
Pant. 188C 163



RUBINA  
Pant. 229C 285



FRESILLA  
Pant. 695C 273



PURPURA  
Pant. 215C 276



CICLAMOR  
Pant. 205C 264



FUCSIA  
Pant. 212C 267



PESCA  
Pant. 218C 275



Standard Colors with [S-]

Other fabric cord colors available upon request. Price increase and minimum quantities may apply

**Digital:** Not all screens are calibrated the same, and therefore, colors will appear differently between screens.

**Physical:** When texture is involved, there will be variations in color, character and tone within a product series and between product families.

Zaneen Group Inc. © 2024, T 1800-388-3382, F 416-247-9319, www.zaneen.com

Available for International specifications by adding 'INT' at the end of the existing Model #. For assistance on 'custom' specifications, contact zteam@zaneen.com.

In a constant effort to supply the best product, we reserve the right to change specifications or materials without notice. The most recent specification sheets are found at zaneen.com

PROJECT \_\_\_\_\_  
 TYPE \_\_\_\_\_  
 NOTES \_\_\_\_\_  
 QUANTITY \_\_\_\_\_  
 DATE \_\_\_\_\_

## COMPLETE COLOR FINISH CHART

ROSA PASTEL  
 Pant. 1905C 281



ALEJANDRIA  
 Pant. 196C 261



CANET  
 Pant. 2717C 43



MALVA  
 Pant. 2567C 141



AMORATADO  
 Pant. 265C 135



LAPIZLAZULI  
 Pant. 2745C 62



VIOLETA  
 Pant. 7676C 147



Standard Colors with [S-]

Other fabric cord colors available upon request. Price increase and minimum quantities may apply

**Digital:** Not all screens are calibrated the same, and therefore, colors will appear differently between screens.

**Physical:** When texture is involved, there will be variations in color, character and tone within a product series and between product families.

Zaneen Group Inc. © 2024, T 1800-388-3382, F 416-247-9319, [www.zaneen.com](http://www.zaneen.com)

Available for International specifications by adding 'INT' at the end of the existing Model #. For assistance on 'custom' specifications, contact [zteam@zaneen.com](mailto:zteam@zaneen.com).

In a constant effort to supply the best product, we reserve the right to change specifications or materials without notice. The most recent specification sheets are found at [zaneen.com](http://zaneen.com)

PROJECT	
TYPE	
SPECIFIER	
QUANTITY	
DATE	

### LEGEND

	floor-mounted		pivotable		special LED (upon request) RGB, RGBW, tunable, gold+, meat+, art+, fashion+
	wall and ceiling: recessed and surface mounted		rotating		warm dim / natural dimming LED
	ceiling-mounted and wall-mounted		illuminate tilted		rechargeable battery powered
	wall-mounted		color of suspension cable		fixture with natural vivid LED (upon request)
	omni-directional light distribution		length of suspension cable		color rendering index
	direct light distribution		reflector degree selection		color temperature
	direct/indirect light distribution		super spot		lumen (luminous flux)
	indirect light distribution		lens		efficacy (lumens per watt)
	asymmetric light distribution		lens pack		Unified Glare Rating (UGR) range from 5-40
	aura light distribution		shine ring		marine grade (AISI 316 stainless steel)
	round wall or ceiling cut-out		integrated shine ring with diffuser		walk on
	square wall or ceiling cut-out		free individual colors 01-29		drive on
	the supplied jig specifies the cutout dimensions		individual colors: 00 (free of charge), 01-25 (extra charge)		Dark Sky Compliance
	minimum distance (meters) lamp - object		luminaire part to be colored (F1)		Americans with Disabilities Act (less than 4" off the wall located between 27"-84" from floor)
	recessed depth		luminaire part to be colored (F2)		lamp protected against explosion
	ceiling thickness in mm		luminaire part to be colored (F3)		blown glass using traditional methods by master glass blower
	ceiling thickness selection		luminaire part to be colored (F4)		acoustic material
	dimmable DP (phase), DV (0-10V), DD (dali), DS (step-dim)		luminaire part to be colored (F5)		protection class I, protection insulation
	included or excluded LED driver/transformer/control gear		color of 3-circuit adaptor		protection class II, protection insulation
	separately switchable		indirect diffuser		ETL Certified to UL and CSA Standards
	sensor		direct diffuser		UL Certified to UL and CSA Standards
	remote control		ball-proof (upon request)		CSA Certified to UL and CSA Standards
	available upon request		accessory		Certified for North American Standards

### IP RATING

	protected against ingress of solid bodies greater than 12.5mm (finger)
	protected against ingress of solid bodies greater than 2.5mm protected against sprays of water up to 60 degrees from the vertical (rain)
	protected against ingress of solid bodies greater than 1mm (wire) no protection against the ingress of moisture
	protected against ingress of solid bodies greater than 1mm (wire) protected against sprays of water up to 60 degrees from the vertical (rain)
	protected against ingress of solid bodies greater than 1mm (wire) protected against water splashed from all directions
	protected against limited ingress of dust (wet rooms/covered outdoor areas) protected against water splashed from all directions
	protected against ingress of dust protected against jets of water
	protected against ingress of dust protected against powerful jets of water or heavy seas
	protected against ingress of dust protected against immersion of water between 15cm - 1m for 30 minutes
	protected against ingress of dust protected against immersion of water under pressure for long periods

### IK RATING

	protected against 0.14 joules impact (equivalent to 0.25kg mass dropped from 56mm above the surface)
	protected against 0.2 joules impact (equivalent to 0.25kg mass dropped from 80mm above the surface)
	protected against 0.35 joules impact (equivalent to 0.25kg mass dropped from 140mm above the surface)
	protected against 0.5 joules impact (equivalent to 0.25kg mass dropped from 200mm above the surface)
	protected against 0.7 joules impact (equivalent to 0.25kg mass dropped from 280mm above the surface)
	protected against 1 joules impact (equivalent to 0.25kg mass dropped from 400mm above the surface)
	protected against 2 joules impact (equivalent to 0.5kg mass dropped from 400mm above the surface)
	protected against 5 joules impact (equivalent to 1.7kg mass dropped from 300mm above the surface)
	protected against 10 joules impact (equivalent to 5.0kg mass dropped from 200mm above the surface)
	protected against 20 joules impact (equivalent to 5.0kg mass dropped from 400mm above the surface)