

## EMISFERO SUSPENSION

### D41017

base number

- To build a product code in our configurator select the specify button on the base model # product page
- To build a manual product code on this datasheet choose from the options listed below in blue font and add the suffix to the base model #

#### GENERAL

Series: Emisfero  
 Brand: Icone  
 Division: Design  
 Mounting Type: Suspension  
 Mounting Location: Ceiling  
 Subcategory: Pendant

#### PHYSICAL

Shape: Abstract  
 Diameter (mm): 160  
 Diameter (in): 6 <sup>5</sup>/<sub>16</sub>  
 Height (mm): 1300  
 Height (in): 51 <sup>3</sup>/<sub>16</sub>  
 Light Distribution: Omnidirectional  
 Weight (kg): 1.1  
 Weight (lbs): 2.499  
 Diffuser: White - Hand Blown Triplex multi Layer Glass  
 Fixture Finish: MWH  
 Holder Finish: White  
 Fixture Material: Aluminum

#### ELECTRICAL

Number of Lamps: 1  
 Lamp Type: LED Retrofit  
 Lamp Shape: T4  
 Bulb Included: Bulb Not Included  
 Max. Wattage Per Lamp (W): 4  
 Lamp Base: G9  
 Input Voltage (V): 120

#### LED

#### OPTICAL

#### RATINGS AND CERTIFICATIONS

Certified By: CSA Certified to UL and CSA Standards  
 IP rating: IP20

PROJECT	
TYPE	
SPECIFIER	
QUANTITY	
DATE	

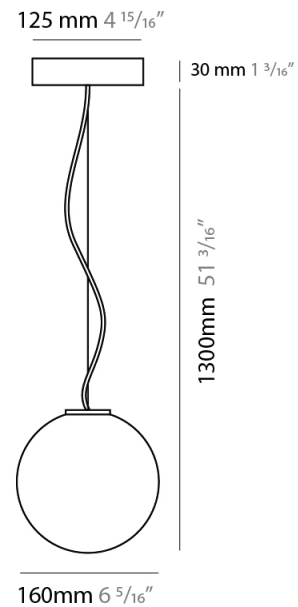

## EMISFERO SUSPENSION

D41017

PROJECT \_\_\_\_\_

TYPE \_\_\_\_\_

SPECIFIER \_\_\_\_\_

QUANTITY \_\_\_\_\_

DATE \_\_\_\_\_



## EMISFERO SUSPENSION

### D41018

base number

- To build a product code in our configurator select the specify button on the base model # product page
- To build a manual product code on this datasheet choose from the options listed below in blue font and add the suffix to the base model #

#### GENERAL

Series: Emisfero  
 Brand: Icone  
 Division: Design  
 Mounting Type: Suspension  
 Mounting Location: Ceiling  
 Subcategory: Pendant

#### PHYSICAL

Shape: Abstract  
 Diameter (mm): 250  
 Diameter (in): 9 <sup>13</sup>/<sub>16</sub>  
 Height (mm): 1400  
 Height (in): 55 <sup>1</sup>/<sub>8</sub>  
 Light Distribution: Omnidirectional  
 Weight (kg): 2.3  
 Weight (lbs): 4.999  
 Diffuser: White - Hand Blown Triplex multi Layer Glass  
 Fixture Finish: MWH  
 Holder Finish: White  
 Fixture Material: Aluminum

#### ELECTRICAL

Number of Lamps: 1  
 Lamp Type: LED Retrofit  
 Lamp Shape: A19  
 Bulb Included: Bulb Not Included  
 Max. Wattage Per Lamp (W): 10  
 Lamp Base: E26  
 Input Voltage (V): 120  
 Upon Request: 277Vac / GU24

#### LED

#### OPTICAL

#### RATINGS AND CERTIFICATIONS

Certified By: CSA Certified to UL and CSA Standards  
 IP rating: IP20

PROJECT	
TYPE	
SPECIFIER	
QUANTITY	
DATE	

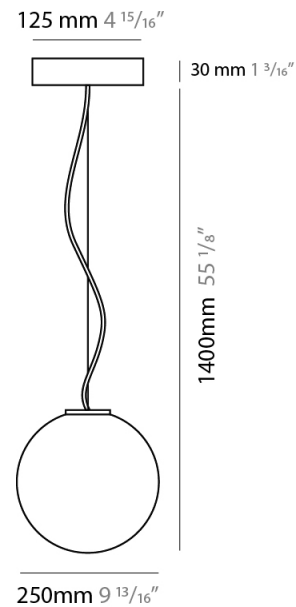

## EMISFERO SUSPENSION

D41018

PROJECT

TYPE

SPECIFIER

QUANTITY

DATE



## EMISFERO SUSPENSION

### D41019

base number

- To build a product code in our configurator select the specify button on the base model # product page
- To build a manual product code on this datasheet choose from the options listed below in blue font and add the suffix to the base model #

#### GENERAL

Series: Emisfero  
 Brand: Icone  
 Division: Design  
 Mounting Type: Suspension  
 Mounting Location: Ceiling  
 Subcategory: Pendant

#### PHYSICAL

Shape: Abstract  
 Diameter (mm): 330  
 Diameter (in): 13  
 Height (mm): 1500  
 Height (in): 59 1/16  
 Light Distribution: Omnidirectional  
 Weight (kg): 5.9  
 Weight (lbs): 12.999  
 Diffuser: White - Hand Blown Triplex multi Layer Glass  
 Fixture Finish: MWH  
 Holder Finish: White  
 Fixture Material: Aluminum

#### ELECTRICAL

Number of Lamps: 1  
 Lamp Type: LED Retrofit  
 Lamp Shape: A19  
 Bulb Included: Bulb Not Included  
 Max. Wattage Per Lamp (W): 15  
 Lamp Base: E26  
 Input Voltage (V): 120  
 Upon Request: 277Vac / GU24

#### LED

#### OPTICAL

#### RATINGS AND CERTIFICATIONS

Certified By: CSA Certified to UL and CSA Standards  
 IP rating: IP20

PROJECT
TYPE
SPECIFIER
QUANTITY
DATE



## EMISFERO SUSPENSION

D41019

PROJECT \_\_\_\_\_

TYPE \_\_\_\_\_

SPECIFIER \_\_\_\_\_

QUANTITY \_\_\_\_\_

DATE \_\_\_\_\_

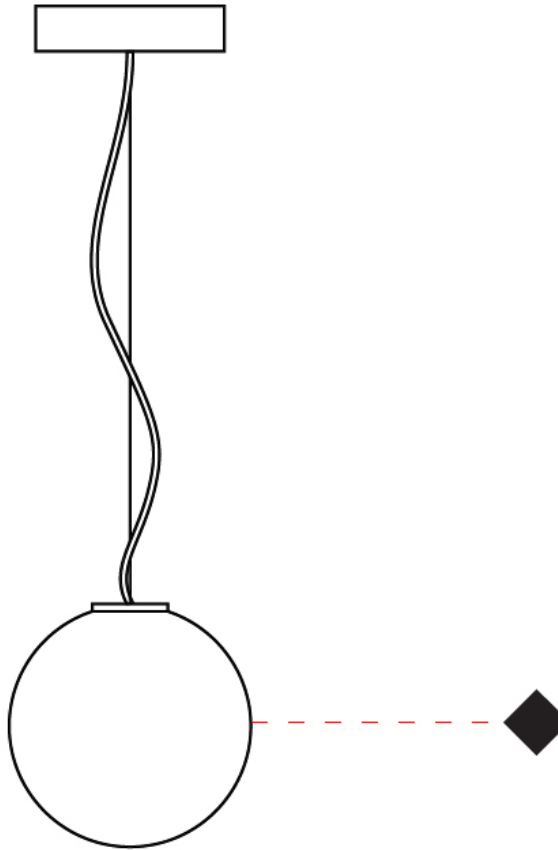

## EMISFERO SUSPENSION

### D41020

base number

- To build a product code in our configurator select the specify button on the base model # product page
- To build a manual product code on this datasheet choose from the options listed below in blue font and add the suffix to the base model #

#### GENERAL

Series: Emisfero  
 Brand: Icone  
 Division: Design  
 Mounting Type: Suspension  
 Mounting Location: Ceiling  
 Subcategory: Pendant

#### PHYSICAL

Shape: Abstract  
 Diameter (mm): 480  
 Diameter (in): 18 7/8  
 Height (mm): 1700  
 Height (in): 66 15/16  
 Light Distribution: Omnidirectional  
 Weight (kg): 6.8  
 Weight (lbs): 14.999  
 Diffuser: White - Hand Blown Triplex multi Layer Glass  
 Fixture Finish: MWH  
 Holder Finish: White  
 Fixture Material: Aluminum

#### ELECTRICAL

Number of Lamps: 1  
 Lamp Type: LED Retrofit  
 Lamp Shape: A19  
 Bulb Included: Bulb Not Included  
 Max. Wattage Per Lamp (W): 24  
 Lamp Base: E26  
 Input Voltage (V): 120  
 Upon Request: 277Vac / GU24

#### LED

#### OPTICAL

#### RATINGS AND CERTIFICATIONS

Certified By: CSA Certified to UL and CSA Standards  
 IP rating: IP20

PROJECT
TYPE
SPECIFIER
QUANTITY
DATE

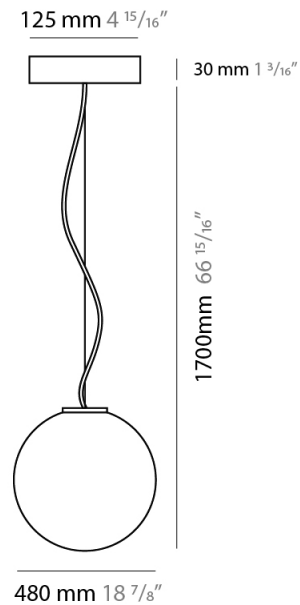

## EMISFERO SUSPENSION

D41020

PROJECT	_____
TYPE	_____
SPECIFIER	_____
QUANTITY	_____
DATE	_____

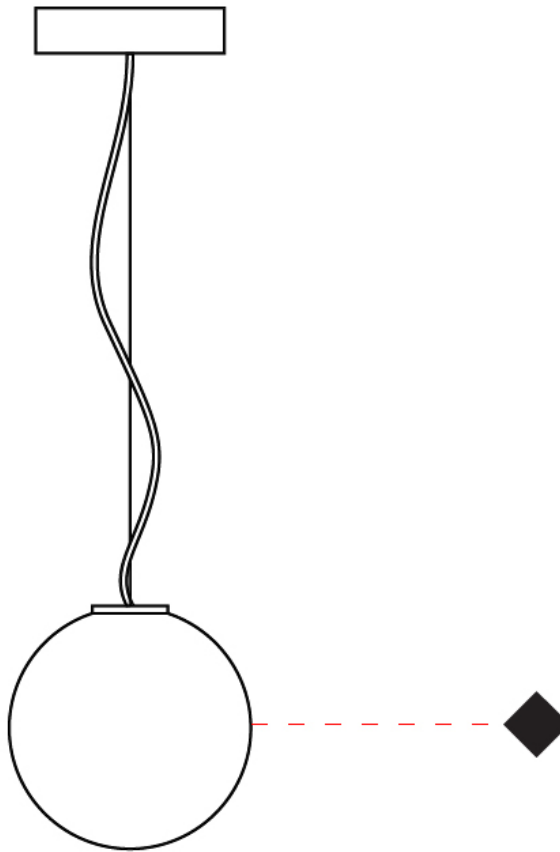



## EMISFERO SURFACE

### D42009

base number

- To build a product code in our configurator select the specify button on the base model # product page
- To build a manual product code on this datasheet choose from the options listed below in blue font and add the suffix to the base model #

#### GENERAL

Series: Emisfero  
 Brand: Icone  
 Division: Design  
 Mounting Type: Surface  
 Mounting Location: Ceiling  
 Subcategory: Ambient

#### PHYSICAL

Shape: Abstract  
 Diameter (mm): 160  
 Diameter (in): 6 <sup>5</sup>/<sub>16</sub>  
 Height (mm): 160  
 Height (in): 6 <sup>3</sup>/<sub>16</sub>  
 Light Distribution: Omnidirectional  
 Weight (kg): 0.7  
 Weight (lbs): 1.4999  
 Diffuser: White - Hand Blown Triplex multi Layer Glass  
 Fixture Finish: MWH  
 Holder Finish: White  
 Fixture Material: Aluminum

#### ELECTRICAL

Number of Lamps: 1  
 Lamp Type: LED Retrofit  
 Lamp Shape: T4  
 Bulb Included: Bulb Not Included  
 Total Output Wattage (W): 6  
 Max. Wattage Per Lamp (W): 6  
 Lamp Base: G9  
 Input Voltage (V): 120

#### LED

#### OPTICAL

#### RATINGS AND CERTIFICATIONS

Certified By: CSA Certified to UL and CSA Standards  
 IP rating: IP20

PROJECT	
TYPE	
SPECIFIER	
QUANTITY	
DATE	

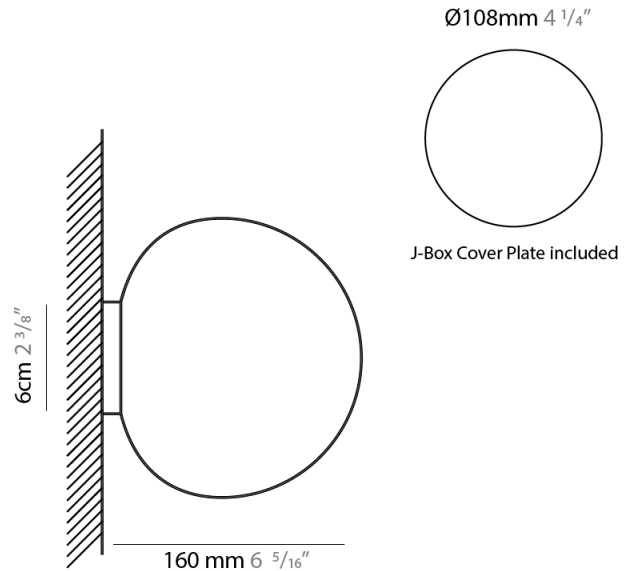

## EMISFERO SURFACE

D42009

PROJECT \_\_\_\_\_

TYPE \_\_\_\_\_

SPECIFIER \_\_\_\_\_

QUANTITY \_\_\_\_\_

DATE \_\_\_\_\_

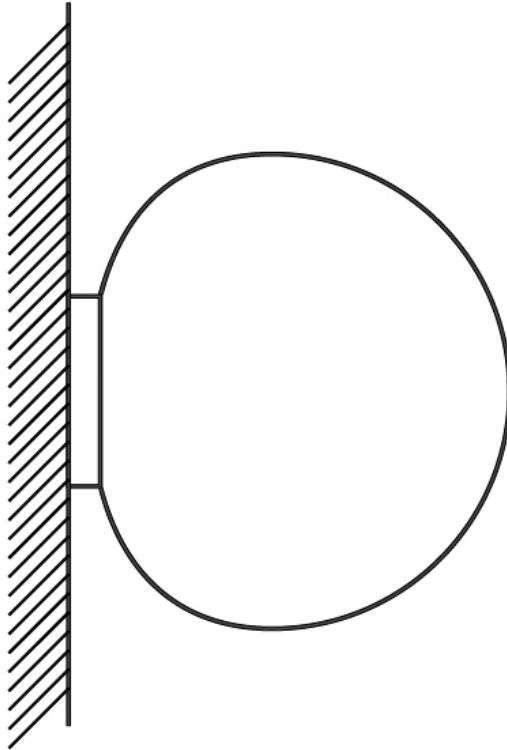

D

## EMISFERO SURFACE

### D42010

base number

- To build a product code in our configurator select the specify button on the base model # product page
- To build a manual product code on this datasheet choose from the options listed below in blue font and add the suffix to the base model #

#### GENERAL

Series: Emisfero  
 Brand: Icone  
 Division: Design  
 Mounting Type: Surface  
 Mounting Location: Ceiling  
 Subcategory: Ambient

#### PHYSICAL

Shape: Abstract  
 Diameter (mm): 250  
 Diameter (in): 9 <sup>13</sup>/<sub>16</sub>  
 Height (mm): 250  
 Height (in): 9 <sup>13</sup>/<sub>16</sub>  
 Light Distribution: Omnidirectional  
 Weight (kg): 1.8  
 Weight (lbs): 3.999  
 Diffuser: White - Hand Blown Triplex multi Layer Glass  
 Fixture Finish: MWH  
 Holder Finish: White  
 Fixture Material: Aluminum

#### ELECTRICAL

Number of Lamps: 1  
 Lamp Type: LED Retrofit  
 Lamp Shape: A19  
 Bulb Included: Bulb Not Included  
 Total Output Wattage (W): 10  
 Max. Wattage Per Lamp (W): 10  
 Lamp Base: E26  
 Input Voltage (V): 120  
 Upon Request: 277Vac / GU24

#### LED

#### OPTICAL

#### RATINGS AND CERTIFICATIONS

Certified By: CSA Certified to UL and CSA Standards  
 IP rating: IP20

PROJECT	
TYPE	
SPECIFIER	
QUANTITY	
DATE	

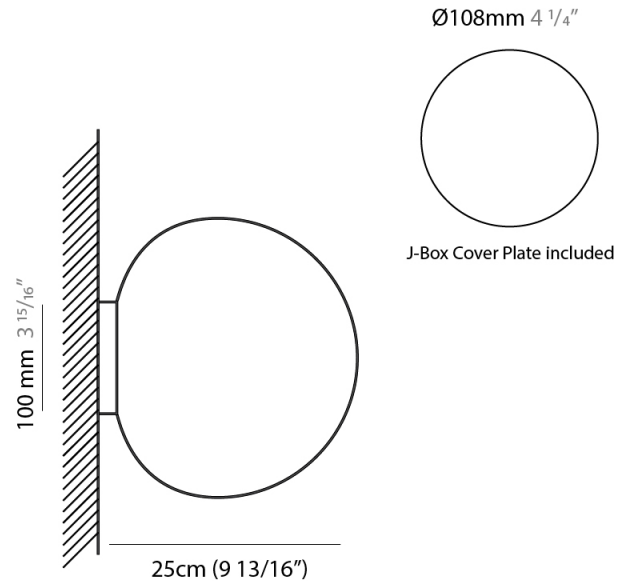

## EMISFERO SURFACE

D42010

PROJECT

TYPE

SPECIFIER

QUANTITY

DATE

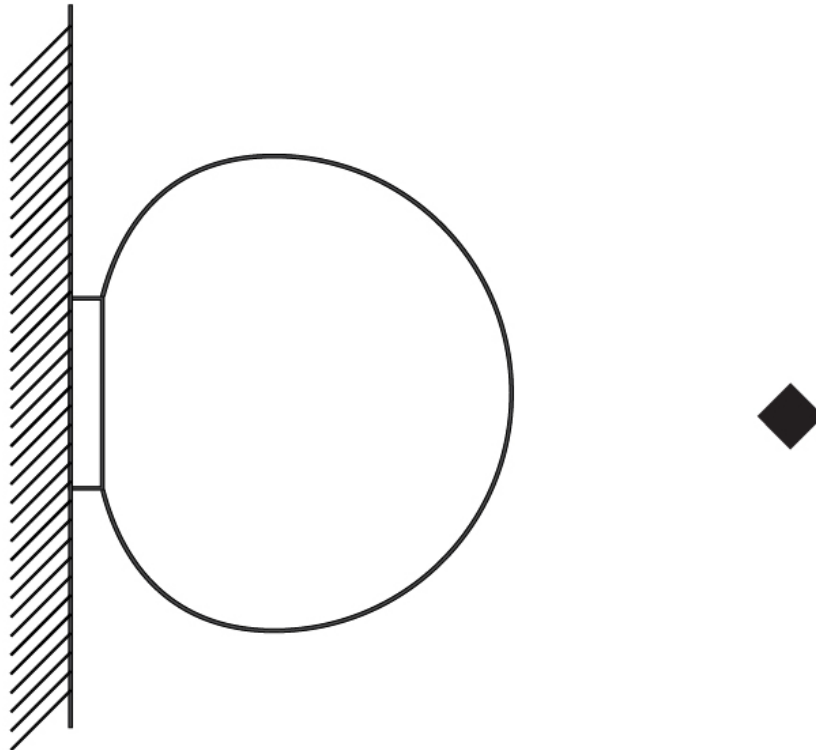

D

## EMISFERO SURFACE

### D42011

base number

- To build a product code in our configurator select the specify button on the base model # product page
- To build a manual product code on this datasheet choose from the options listed below in blue font and add the suffix to the base model #

#### GENERAL

Series: Emisfero  
 Brand: Icone  
 Division: Design  
 Mounting Type: Surface  
 Mounting Location: Ceiling  
 Subcategory: Ambient

#### PHYSICAL

Shape: Abstract  
 Diameter (mm): 330  
 Diameter (in): 13  
 Height (mm): 330  
 Height (in): 13  
 Light Distribution: Omnidirectional  
 Weight (kg): 3.2  
 Weight (lbs): 6.999  
 Diffuser: White - Hand Blown Triplex multi Layer Glass  
 Fixture Finish: MWH  
 Holder Finish: White  
 Fixture Material: Aluminum

#### ELECTRICAL

Number of Lamps: 1  
 Lamp Type: LED Retrofit  
 Lamp Shape: A19  
 Bulb Included: Bulb Not Included  
 Total Output Wattage (W): 15  
 Max. Wattage Per Lamp (W): 15  
 Lamp Base: E26  
 Input Voltage (V): 120  
 Upon Request: 277Vac / GU24

#### LED

#### OPTICAL

#### RATINGS AND CERTIFICATIONS

Certified By: CSA Certified to UL and CSA Standards  
 IP rating: IP20

PROJECT	
TYPE	
SPECIFIER	
QUANTITY	
DATE	

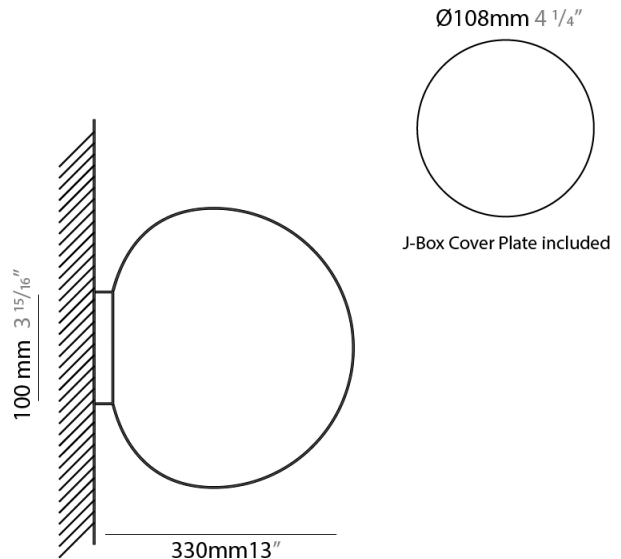

## EMISFERO SURFACE

D42011

PROJECT

TYPE

SPECIFIER

QUANTITY

DATE

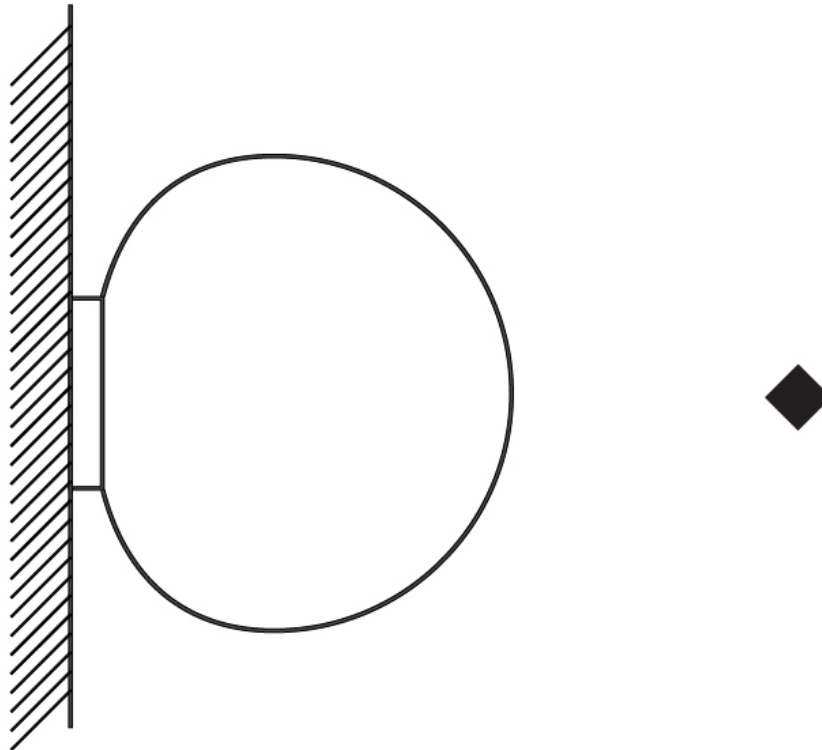

D

## EMISFERO SURFACE

### D42012

base number

1. To build a product code in our configurator select the specify button on the base model # product page
2. To build a manual product code on this datasheet choose from the options listed below in blue font and add the suffix to the base model #

#### GENERAL

Series: Emisfero  
Brand: Icone  
Division: Design  
Mounting Type: Surface  
Mounting Location: Ceiling  
Subcategory: Ambient

#### PHYSICAL

Shape: Abstract  
Diameter (mm): 480  
Diameter (in): 18 <sup>7</sup>/<sub>8</sub>  
Height (mm): 480  
Height (in): 18 <sup>7</sup>/<sub>8</sub>  
Light Distribution: Omnidirectional  
Weight (kg): 6.3  
Weight (lbs): 13.999  
Diffuser: White - Hand Blown Triplex multi Layer Glass  
Fixture Finish: MWH  
Holder Finish: White  
Fixture Material: Aluminum

#### ELECTRICAL

Number of Lamps: 1  
Lamp Type: LED Retrofit  
Lamp Shape: A19  
Bulb Included: Bulb Not Included  
Total Output Wattage (W): 24  
Max. Wattage Per Lamp (W): 24  
Lamp Base: E26  
Input Voltage (V): 120  
Upon Request: 277Vac / GU24

#### LED

#### OPTICAL

#### RATINGS AND CERTIFICATIONS

Certified By: CSA Certified to UL and CSA Standards  
IP rating: IP20

PROJECT	_____
TYPE	_____
SPECIFIER	_____
QUANTITY	_____
DATE	_____



D42012

PROJECT

TYPE

SPECIFIER

QUANTITY

DATE

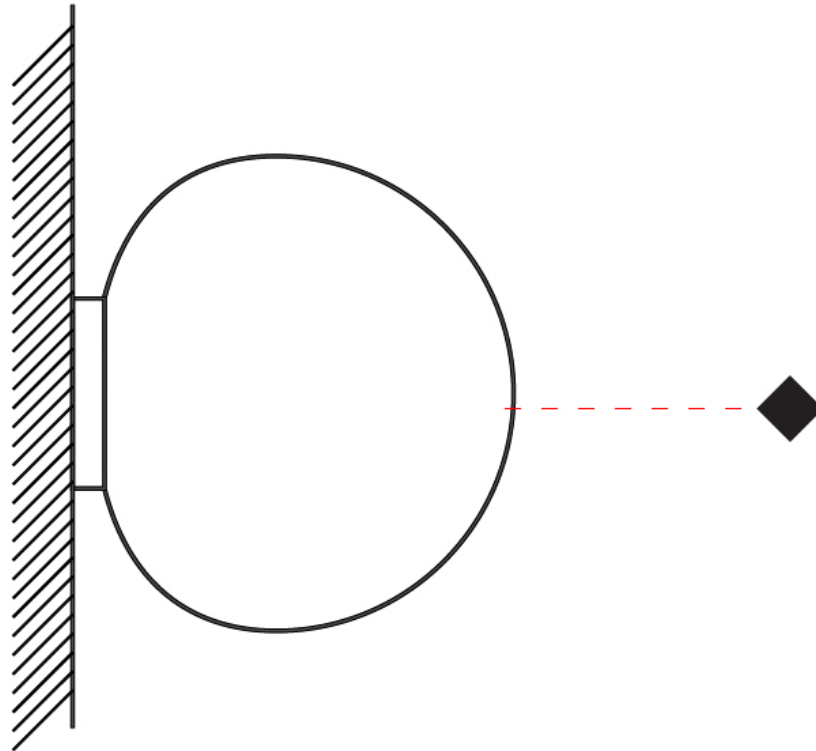

D



PROJECT

TYPE

SPECIFIER

QUANTITY

DATE

### Fixture Finish

Matte White - MWH

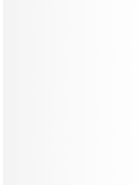

### Holder Finish

**Digital:** Not all screens are calibrated the same, and therefore, colors will appear differently between screens.

**Physical:** When texture is involved, there will be variations in color, character and tone within a product series and between product families.













### LEGEND

	floor-mounted		pivotal		special LED (upon request) RGB, RGBW, tunable, gold+, meat+, art+, fashion+
	wall and ceiling: recessed and surface mounted		rotating		warm dim / natural dimming LED
	ceiling-mounted and wall-mounted		illuminate tilted		rechargeable battery powered
	wall-mounted		color of suspension cable		fixture with natural vivid LED (upon request)
	omni-directional light distribution		length of suspension cable		color rendering index
	direct light distribution		reflector degree selection		color temperature
	direct/indirect light distribution		super spot		lumen (luminous flux)
	indirect light distribution		lens		efficacy (lumens per watt)
	asymmetric light distribution		lens pack		Unified Glare Rating (UGR) range from 5-40
	aura light distribution		shine ring		marine grade (AISI 316 stainless steel)
	round wall or ceiling cut-out		integrated shine ring with diffuser		walk on
	square wall or ceiling cut-out		free individual colors 01-29		drive on
	the supplied jig specifies the cutout dimensions		individual colors: 00 (free of charge), 01-25 (extra charge)		Dark Sky Compliance
	minimum distance (meters) lamp - object		luminaire part to be colored (F1)		Americans with Disabilities Act (less than 4" off the wall located between 27"-84" from floor)
	recessed depth		luminaire part to be colored (F2)		lamp protected against explosion
	ceiling thickness in mm		luminaire part to be colored (F3)		blown glass using traditional methods by master glass blower
	ceiling thickness selection		luminaire part to be colored (F4)		acoustic material
	dimmable DP (phase), DV (0-10V), DD (dali), DS (step-dim)		luminaire part to be colored (F5)		protection class I, protection insulation
	included or excluded LED driver/transformer/control gear		color of 3-circuit adaptor		protection class II, protection insulation
	separately switchable		indirect diffuser		ETL Certified to UL and CSA Standards
	sensor		direct diffuser		UL Certified to UL and CSA Standards
	remote control		ball-proof (upon request)		CSA Certified to UL and CSA Standards
	available upon request		accessory		Certified for North American Standards

### IP RATING

	protected against ingress of solid bodies greater than 12.5mm (finger)
	protected against ingress of solid bodies greater than 2.5mm protected against sprays of water up to 60 degrees from the vertical (rain)
	protected against ingress of solid bodies greater than 1mm (wire) no protection against the ingress of moisture
	protected against ingress of solid bodies greater than 1mm (wire) protected against sprays of water up to 60 degrees from the vertical (rain)
	protected against ingress of solid bodies greater than 1mm (wire) protected against water splashed from all directions
	protected against limited ingress of dust (wet rooms/covered outdoor areas) protected against water splashed from all directions
	protected against ingress of dust protected against jets of water
	protected against ingress of dust protected against powerful jets of water or heavy seas
	protected against ingress of dust protected against immersion of water between 15cm - 1m for 30 minutes
	protected against ingress of dust protected against immersion of water under pressure for long periods

### IK RATING

	protected against 0.14 joules impact (equivalent to 0.25kg mass dropped from 56mm above the surface)
	protected against 0.2 joules impact (equivalent to 0.25kg mass dropped from 80mm above the surface)
	protected against 0.35 joules impact (equivalent to 0.25kg mass dropped from 140mm above the surface)
	protected against 0.5 joules impact (equivalent to 0.25kg mass dropped from 200mm above the surface)
	protected against 0.7 joules impact (equivalent to 0.25kg mass dropped from 280mm above the surface)
	protected against 1 joules impact (equivalent to 0.25kg mass dropped from 400mm above the surface)
	protected against 2 joules impact (equivalent to 0.5kg mass dropped from 400mm above the surface)
	protected against 5 joules impact (equivalent to 1.7kg mass dropped from 300mm above the surface)
	protected against 10 joules impact (equivalent to 5.0kg mass dropped from 200mm above the surface)
	protected against 20 joules impact (equivalent to 5.0kg mass dropped from 400mm above the surface)