

EMISFERO SUSPENSION

D41017

base number

- To build a product code in our configurator select the specify button on the base model # product page
- To build a manual product code on this datasheet choose from the options listed below in blue font and add the suffix to the base model #

GENERAL

Series: Emisfero
 Partner: Icone
 Division: Design
 Installation: Suspension
 Product Type: Pendant
 Mounting Location: Ceiling

PHYSICAL

Shape: Abstract
 Diameter (mm): 160
 Diameter (in): 6 ⁵/₁₆
 Height (mm): 1300
 Height (in): 51 ³/₁₆
 Weight (kg): 1.1
 Weight (lbs): 2.499
 Diffuser: White - Hand Blown Triplex multi Layer Glass
 Fixture Finish: MWH
 Holder Finish: White
 Fixture Material: Aluminum
 Primary Material: Glass

ELECTRICAL

Number of Lamps: 1
 Lamp Type: LED Retrofit
 Lamp Shape: T4
 Bulb Included: Bulb Not Included
 Max. Wattage Per Lamp (W): 4
 Lamp Base: G9
 Input Voltage (V): 120

LED

OPTICAL

RATINGS AND CERTIFICATIONS

Certified By: CSA Certified to UL and CSA Standards
 IP rating: IP20

PROJECT	
TYPE	
SPECIFIER	
QUANTITY	
DATE	

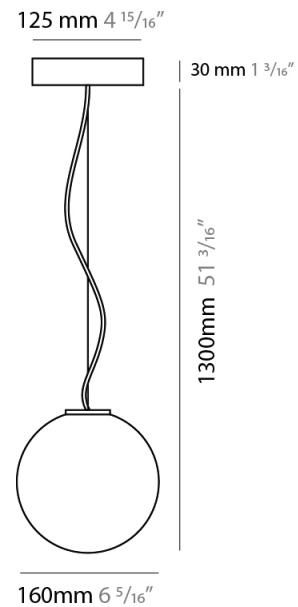

EMISFERO SUSPENSION

D41017

PROJECT _____

TYPE _____

SPECIFIER _____

QUANTITY _____

DATE _____



EMISFERO SUSPENSION

D41018

base number

- To build a product code in our configurator select the specify button on the base model # product page
- To build a manual product code on this datasheet choose from the options listed below in blue font and add the suffix to the base model #

GENERAL

Series: Emisfero
 Partner: Icone
 Division: Design
 Installation: Suspension
 Product Type: Pendant
 Mounting Location: Ceiling

PHYSICAL

Shape: Abstract
 Diameter (mm): 250
 Diameter (in): 9 ¹³/₁₆
 Height (mm): 1400
 Height (in): 55 ¹/₈
 Weight (kg): 2.3
 Weight (lbs): 4.999
 Diffuser: White - Hand Blown Triplex multi Layer Glass
 Fixture Finish: MWH
 Holder Finish: White
 Fixture Material: Aluminum
 Primary Material: Glass

ELECTRICAL

Number of Lamps: 1
 Lamp Type: LED Retrofit
 Lamp Shape: A19
 Bulb Included: Bulb Not Included
 Max. Wattage Per Lamp (W): 10
 Lamp Base: E26
 Input Voltage (V): 120
 Upon Request: 277Vac / GU24

LED

OPTICAL

RATINGS AND CERTIFICATIONS

Certified By: CSA Certified to UL and CSA Standards
 IP rating: IP20

PROJECT	
TYPE	
SPECIFIER	
QUANTITY	
DATE	

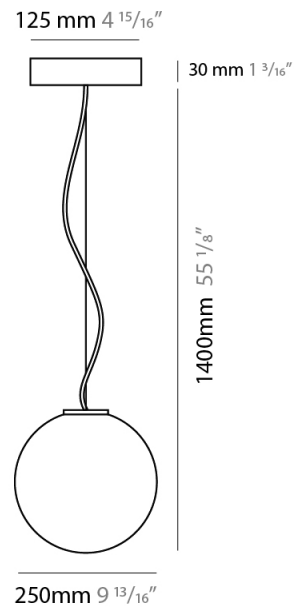

EMISFERO SUSPENSION

D41018

PROJECT _____

TYPE _____

SPECIFIER _____

QUANTITY _____

DATE _____

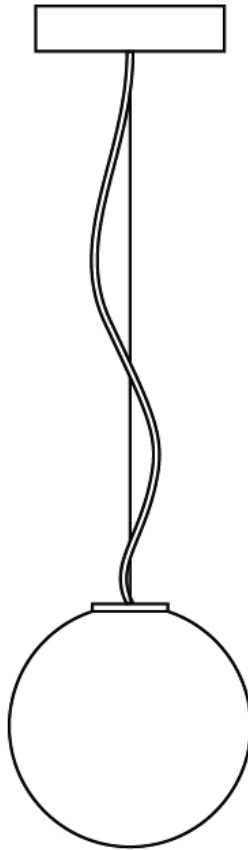

EMISFERO SUSPENSION

D41019

base number

- To build a product code in our configurator select the specify button on the base model # product page
- To build a manual product code on this datasheet choose from the options listed below in blue font and add the suffix to the base model #

GENERAL

Series: Emisfero
 Partner: Icone
 Division: Design
 Installation: Suspension
 Product Type: Pendant
 Mounting Location: Ceiling

PHYSICAL

Shape: Abstract
 Diameter (mm): 330
 Diameter (in): 13
 Height (mm): 1500
 Height (in): 59 1/16
 Weight (kg): 5.9
 Weight (lbs): 12.999
 Diffuser: White - Hand Blown Triplex multi Layer Glass
 Fixture Finish: MWH
 Holder Finish: White
 Fixture Material: Aluminum
 Primary Material: Glass

ELECTRICAL

Number of Lamps: 1
 Lamp Type: LED Retrofit
 Lamp Shape: A19
 Bulb Included: Bulb Not Included
 Max. Wattage Per Lamp (W): 15
 Lamp Base: E26
 Input Voltage (V): 120
 Upon Request: 277Vac / GU24

LED

OPTICAL

RATINGS AND CERTIFICATIONS

Certified By: CSA Certified to UL and CSA Standards
 IP rating: IP20

PROJECT
TYPE
SPECIFIER
QUANTITY
DATE

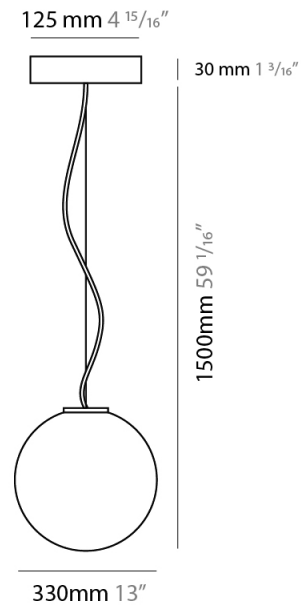

EMISFERO SUSPENSION

D41019

PROJECT _____

TYPE _____

SPECIFIER _____

QUANTITY _____

DATE _____

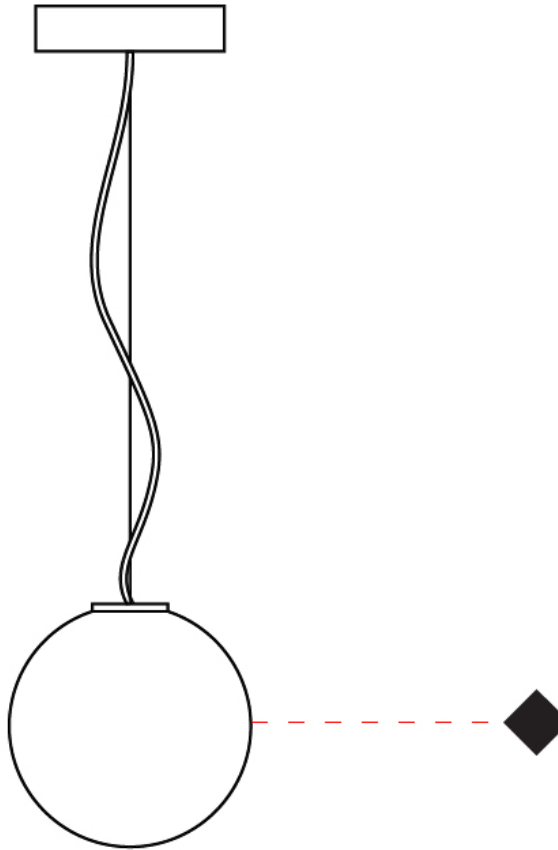

EMISFERO SUSPENSION

D41020

base number

- To build a product code in our configurator select the specify button on the base model # product page
- To build a manual product code on this datasheet choose from the options listed below in blue font and add the suffix to the base model #

GENERAL

Series: Emisfero
 Partner: Icone
 Division: Design
 Installation: Suspension
 Product Type: Pendant
 Mounting Location: Ceiling

PHYSICAL

Shape: Abstract
 Diameter (mm): 480
 Diameter (in): 18 7/8
 Height (mm): 1700
 Height (in): 66 15/16
 Weight (kg): 6.8
 Weight (lbs): 14.999
 Diffuser: White - Hand Blown Triplex multi Layer Glass
 Fixture Finish: MWH
 Holder Finish: White
 Fixture Material: Aluminum
 Primary Material: Glass

ELECTRICAL

Number of Lamps: 1
 Lamp Type: LED Retrofit
 Lamp Shape: A19
 Bulb Included: Bulb Not Included
 Max. Wattage Per Lamp (W): 24
 Lamp Base: E26
 Input Voltage (V): 120
 Upon Request: 277Vac / GU24

LED

OPTICAL

RATINGS AND CERTIFICATIONS

Certified By: CSA Certified to UL and CSA Standards
 IP rating: IP20

PROJECT	
TYPE	
SPECIFIER	
QUANTITY	
DATE	

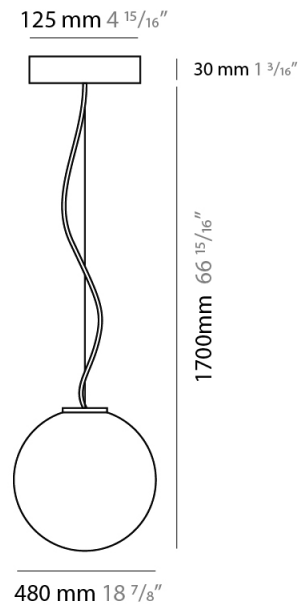

EMISFERO SUSPENSION

D41020

PROJECT	_____
TYPE	_____
SPECIFIER	_____
QUANTITY	_____
DATE	_____

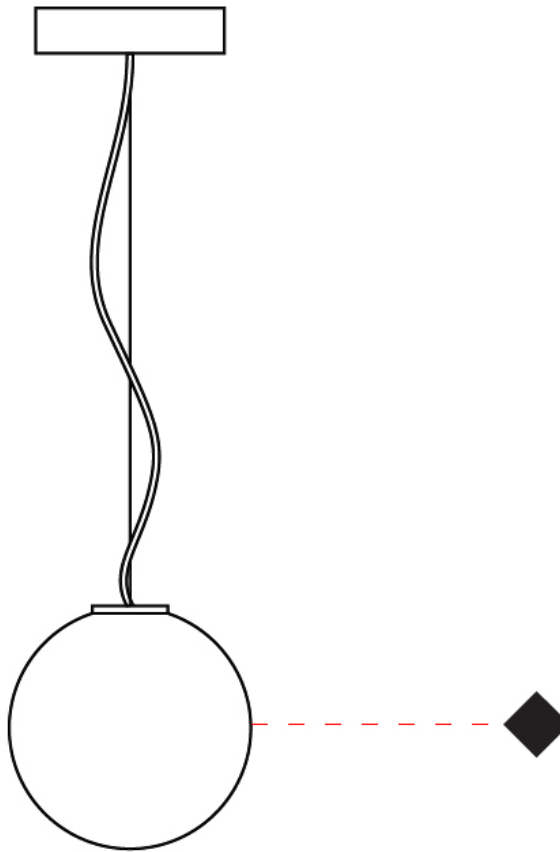

EMISFERO SURFACE

D42009

base number

- To build a product code in our configurator select the specify button on the base model # product page
- To build a manual product code on this datasheet choose from the options listed below in blue font and add the suffix to the base model #

GENERAL

Series: Emisfero
 Partner: Icone
 Division: Design
 Installation: Surface
 Product Type: Ceiling Surface
 Mounting Location: Ceiling

PHYSICAL

Shape: Abstract
 Diameter (mm): 160
 Diameter (in): 6 ⁵/₁₆
 Height (mm): 160
 Height (in): 6 ³/₁₆
 Weight (kg): 0.7
 Weight (lbs): 1.4999
 Diffuser: White - Hand Blown Triplex multi Layer Glass
 Fixture Finish: MWH
 Holder Finish: White
 Fixture Material: Aluminum
 Primary Material: Glass

ELECTRICAL

Number of Lamps: 1
 Lamp Type: LED Retrofit
 Lamp Shape: T4
 Bulb Included: Bulb Not Included
 Total Output Wattage (W): 6
 Max. Wattage Per Lamp (W): 6
 Lamp Base: G9
 Input Voltage (V): 120

LED

OPTICAL

RATINGS AND CERTIFICATIONS

Certified By: CSA Certified to UL and CSA Standards
 IP rating: IP20

PROJECT	
TYPE	
SPECIFIER	
QUANTITY	
DATE	

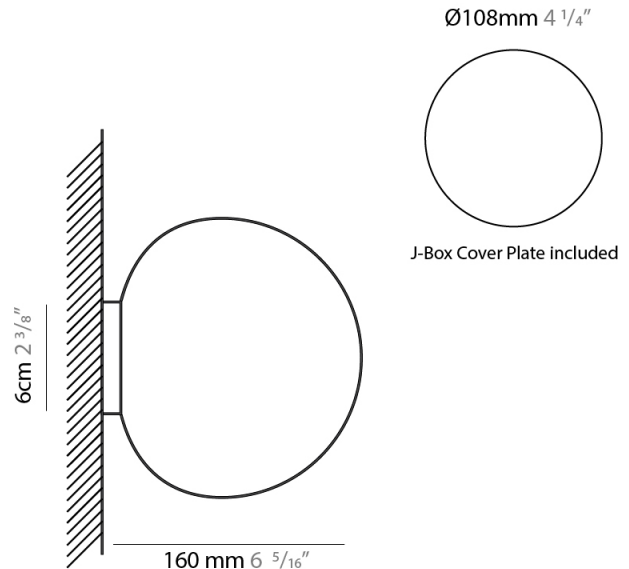

EMISFERO SURFACE

D42009

PROJECT

TYPE

SPECIFIER

QUANTITY

DATE

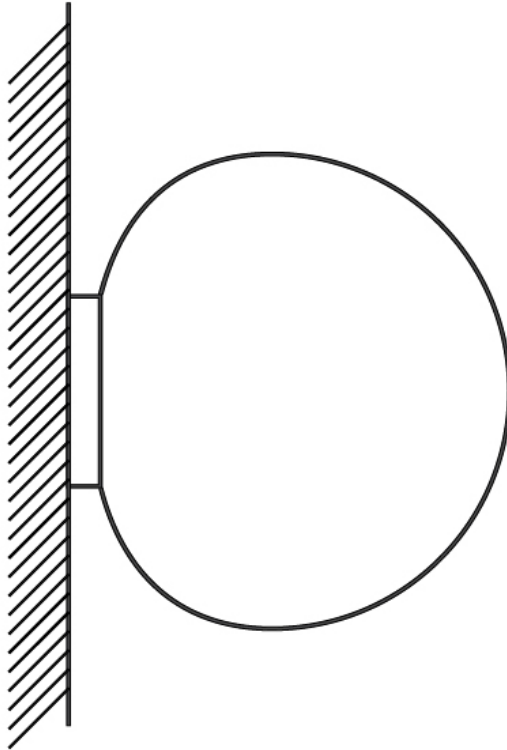

D

EMISFERO SURFACE

D42010

base number

- To build a product code in our configurator select the specify button on the base model # product page
- To build a manual product code on this datasheet choose from the options listed below in blue font and add the suffix to the base model #

GENERAL

Series: Emisfero
 Partner: Icone
 Division: Design
 Installation: Surface
 Product Type: Ceiling Surface
 Mounting Location: Ceiling

PHYSICAL

Shape: Abstract
 Diameter (mm): 250
 Diameter (in): 9 ¹³/₁₆
 Height (mm): 250
 Height (in): 9 ¹³/₁₆
 Weight (kg): 1.8
 Weight (lbs): 3.999
 Diffuser: White - Hand Blown Triplex multi Layer Glass
 Fixture Finish: MWH
 Holder Finish: White
 Fixture Material: Aluminum
 Primary Material: Glass

ELECTRICAL

Number of Lamps: 1
 Lamp Type: LED Retrofit
 Lamp Shape: A19
 Bulb Included: Bulb Not Included
 Total Output Wattage (W): 10
 Max. Wattage Per Lamp (W): 10
 Lamp Base: E26
 Input Voltage (V): 120
 Upon Request: 277Vac / GU24

LED

OPTICAL

RATINGS AND CERTIFICATIONS

Certified By: CSA Certified to UL and CSA Standards
 IP rating: IP20

PROJECT
TYPE
SPECIFIER
QUANTITY
DATE

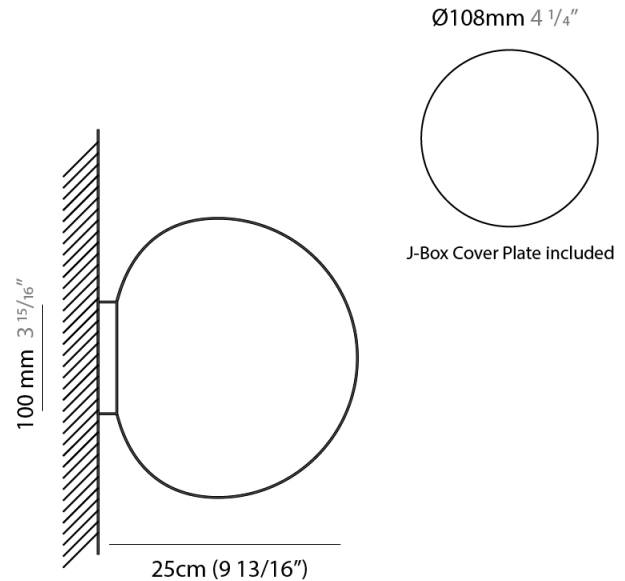

EMISFERO SURFACE

D42010

PROJECT

TYPE

SPECIFIER

QUANTITY

DATE

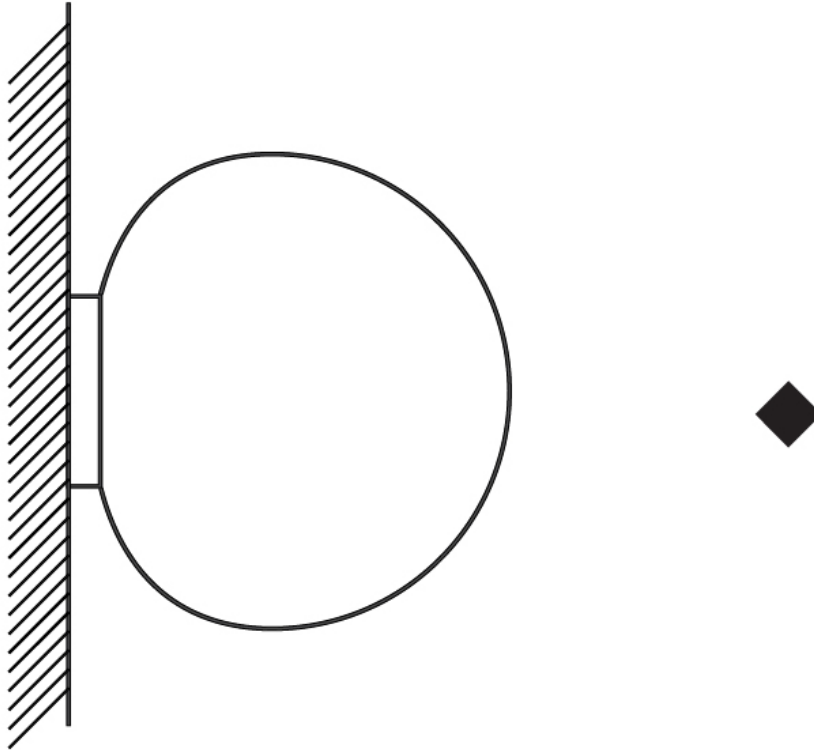

D

EMISFERO SURFACE

D42011

base number

- To build a product code in our configurator select the specify button on the base model # product page
- To build a manual product code on this datasheet choose from the options listed below in blue font and add the suffix to the base model #

GENERAL

Series: Emisfero
 Partner: Icone
 Division: Design
 Installation: Surface
 Product Type: Ceiling Surface
 Mounting Location: Ceiling

PHYSICAL

Shape: Abstract
 Diameter (mm): 330
 Diameter (in): 13
 Height (mm): 330
 Height (in): 13
 Weight (kg): 3.2
 Weight (lbs): 6.999
 Diffuser: White - Hand Blown Triplex multi Layer Glass
 Fixture Finish: MWH
 Holder Finish: White
 Fixture Material: Aluminum
 Primary Material: Glass

ELECTRICAL

Number of Lamps: 1
 Lamp Type: LED Retrofit
 Lamp Shape: A19
 Bulb Included: Bulb Not Included
 Total Output Wattage (W): 15
 Max. Wattage Per Lamp (W): 15
 Lamp Base: E26
 Input Voltage (V): 120
 Upon Request: 277Vac / GU24

LED

OPTICAL

RATINGS AND CERTIFICATIONS

Certified By: CSA Certified to UL and CSA Standards
 IP rating: IP20

PROJECT	
TYPE	
SPECIFIER	
QUANTITY	
DATE	

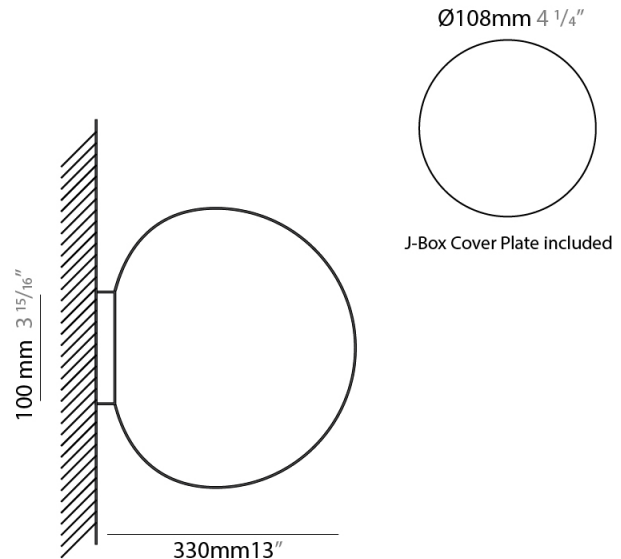

EMISFERO SURFACE

D42011

PROJECT

TYPE

SPECIFIER

QUANTITY

DATE

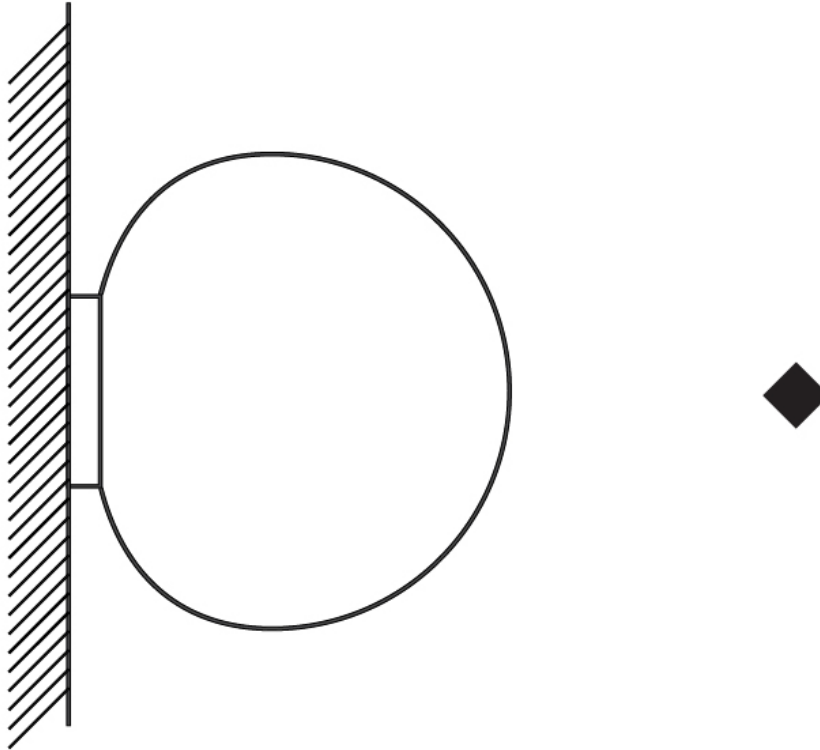

D

EMISFERO SURFACE

D42012

base number

- To build a product code in our configurator select the specify button on the base model # product page
- To build a manual product code on this datasheet choose from the options listed below in blue font and add the suffix to the base model #

GENERAL

Series: Emisfero
 Partner: Icone
 Division: Design
 Installation: Surface
 Product Type: Ceiling Surface
 Mounting Location: Ceiling

PHYSICAL

Shape: Abstract
 Diameter (mm): 480
 Diameter (in): 18 7/8
 Height (mm): 480
 Height (in): 18 7/8
 Weight (kg): 6.3
 Weight (lbs): 13.999
 Diffuser: White - Hand Blown Triplex multi Layer Glass
 Fixture Finish: MWH
 Holder Finish: White
 Fixture Material: Aluminum
 Primary Material: Glass

ELECTRICAL

Number of Lamps: 1
 Lamp Type: LED Retrofit
 Lamp Shape: A19
 Bulb Included: Bulb Not Included
 Total Output Wattage (W): 24
 Max. Wattage Per Lamp (W): 24
 Lamp Base: E26
 Input Voltage (V): 120
 Upon Request: 277Vac / GU24

LED

OPTICAL

RATINGS AND CERTIFICATIONS

Certified By: CSA Certified to UL and CSA Standards
 IP rating: IP20

PROJECT
TYPE
SPECIFIER
QUANTITY
DATE

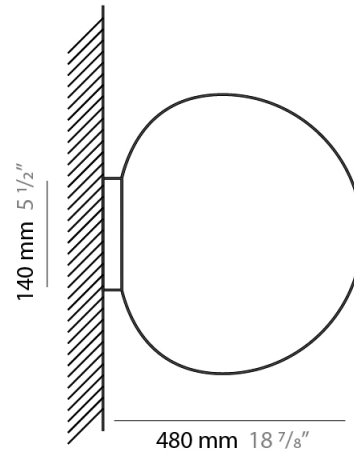

EMISFERO SURFACE

D42012

PROJECT

TYPE

SPECIFIER

QUANTITY

DATE

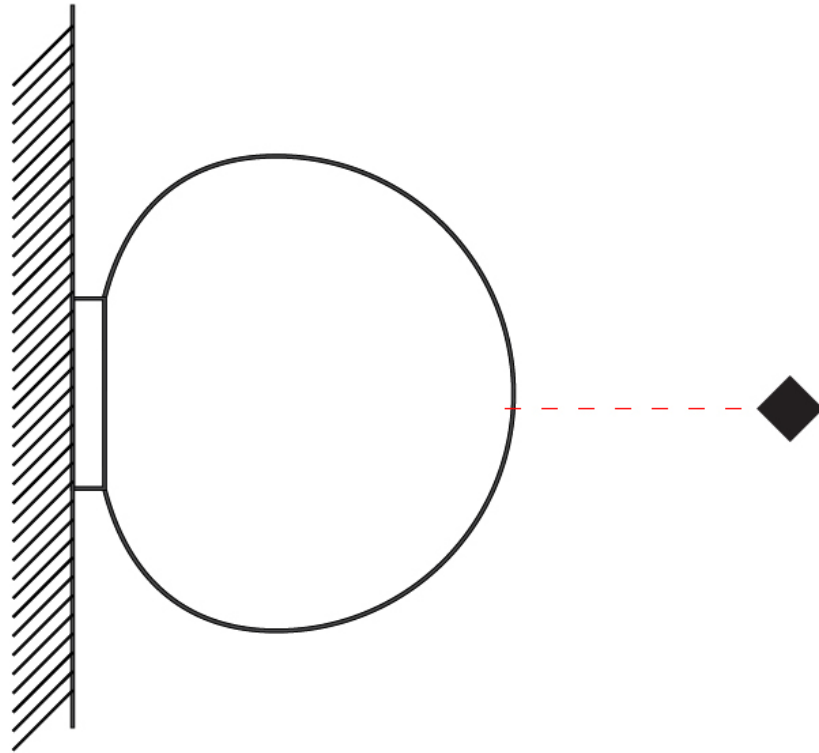

D

EMISFERO PORTABLE

D44000

base number

1. To build a product code in our configurator select the specify button on the base model # product page
2. To build a manual product code on this datasheet choose from the options listed below in blue font and add the suffix to the base model #

GENERAL

Series: Emisfero
Partner: Icone
Division: Design
Installation: Portable
Product Type: Table
Mounting Location: Table
Light Distribution: Direct

PHYSICAL

Shape: Abstract
Diameter (mm): 160
Diameter (in): 6 ⁵/₁₆
Extension (mm): 160
Extension (in): 6 ⁵/₁₆
Weight (kg): 0.9
Weight (lbs): 2.099
Diffuser: White - Hand Blown Triplex multi Layer Glass
Holder Finish: White
Fixture Material: Aluminum
Primary Material: Glass
Upon Request: Bolt Down

ELECTRICAL

Number of Lamps: 1
Lamp Type: LED Retrofit
Lamp Shape: T4
Bulb Included: Bulb Not Included
Max. Wattage Per Lamp (W): 6
Lamp Base: G9
Input Voltage (V): 120

LED

OPTICAL

RATINGS AND CERTIFICATIONS

Certified By: CSA Certified to UL and CSA Standards
IP rating: IP20

PROJECT	_____
TYPE	_____
SPECIFIER	_____
QUANTITY	_____
DATE	_____



Ø108mm 4 1/4"

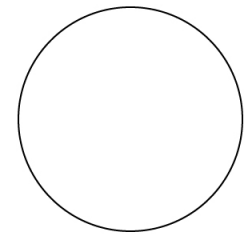

J-Box Cover Plate included

160 mm 6 5/16"

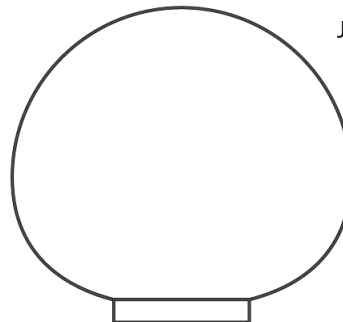

80mm 3 1/8"



D44000

PROJECT

TYPE

SPECIFIER

QUANTITY

DATE

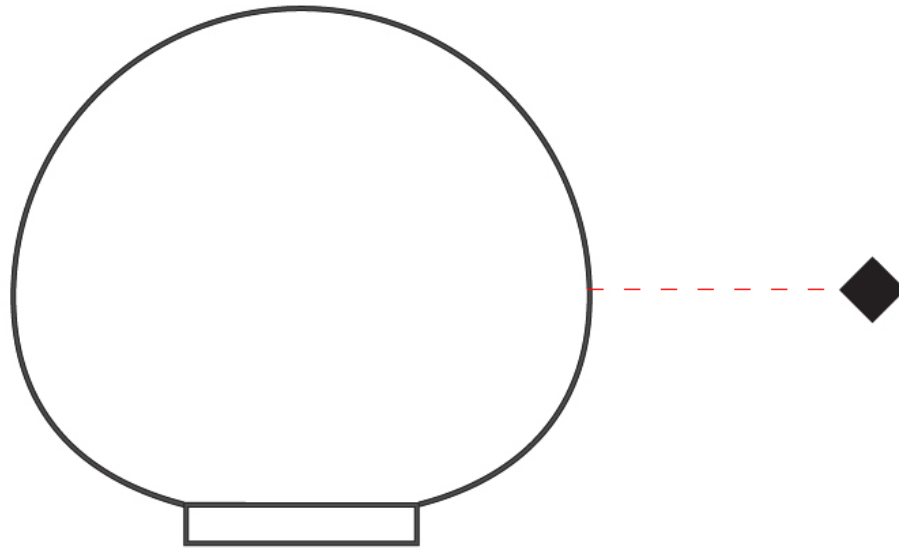

EMISFERO PORTABLE

D44001

base number

1. To build a product code in our configurator select the specify button on the base model # product page
2. To build a manual product code on this datasheet choose from the options listed below in blue font and add the suffix to the base model #

GENERAL

Series: Emisfero
Partner: Icone
Division: Design
Installation: Portable
Product Type: Table
Mounting Location: Table
Light Distribution: Direct

PHYSICAL

Shape: Abstract
Diameter (mm): 250
Diameter (in): 9 ¹³/₁₆
Extension (mm): 250
Extension (in): 9 ¹³/₁₆
Weight (kg): 3
Weight (lbs): 6.599
Diffuser: White - Hand Blown Triplex multi Layer Glass
Holder Finish: White
Fixture Material: Aluminum
Primary Material: Glass
Upon Request: Bolt Down

ELECTRICAL

Number of Lamps: 1
Lamp Type: LED Retrofit
Lamp Shape: A19
Bulb Included: Bulb Not Included
Max. Wattage Per Lamp (W): 10
Lamp Base: E26
Input Voltage (V): 120
Upon Request: 277Vac / GU24

LED

OPTICAL

RATINGS AND CERTIFICATIONS

Certified By: CSA Certified to UL and CSA Standards
IP rating: IP20

PROJECT	_____
TYPE	_____
SPECIFIER	_____
QUANTITY	_____
DATE	_____

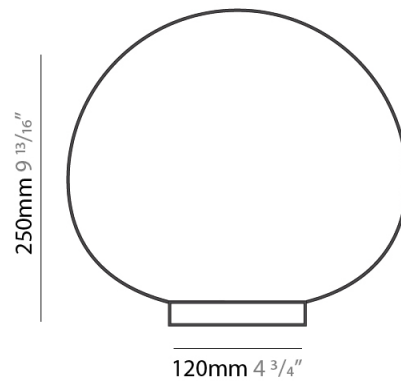

D44001

PROJECT

TYPE

SPECIFIER

QUANTITY

DATE

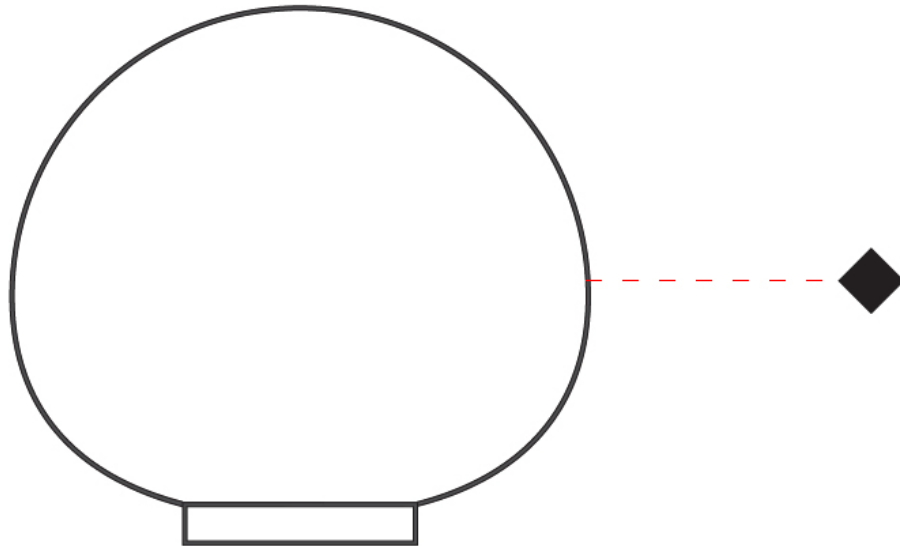

D

EMISFERO PORTABLE

D44002

base number

1. To build a product code in our configurator select the specify button on the base model # product page
2. To build a manual product code on this datasheet choose from the options listed below in blue font and add the suffix to the base model #

GENERAL

Series: Emisfero
Partner: Icone
Division: Design
Installation: Portable
Product Type: Table
Mounting Location: Floor
Light Distribution: Direct

PHYSICAL

Shape: Abstract
Diameter (mm): 330
Diameter (in): 13
Extension (mm): 120
Extension (in): 4 ³/₄
Weight (kg): 3.6
Weight (lbs): 7.999
Diffuser: White - Hand Blown Triplex multi Layer Glass
Holder Finish: White
Fixture Material: Aluminum
Primary Material: Glass
Upon Request: Bolt Down

ELECTRICAL

Number of Lamps: 1
Lamp Type: LED Retrofit
Lamp Shape: A19
Bulb Included: Bulb Not Included
Max. Wattage Per Lamp (W): 15
Lamp Base: E26
Input Voltage (V): 120
Upon Request: 277Vac / GU24

LED

OPTICAL

RATINGS AND CERTIFICATIONS

Certified By: CSA Certified to UL and CSA Standards
IP rating: IP20

PROJECT

TYPE

SPECIFIER

QUANTITY

DATE

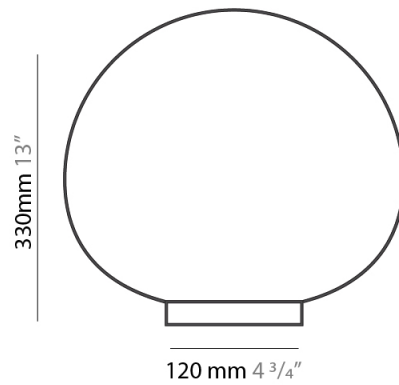

D44002

PROJECT

TYPE

SPECIFIER

QUANTITY

DATE

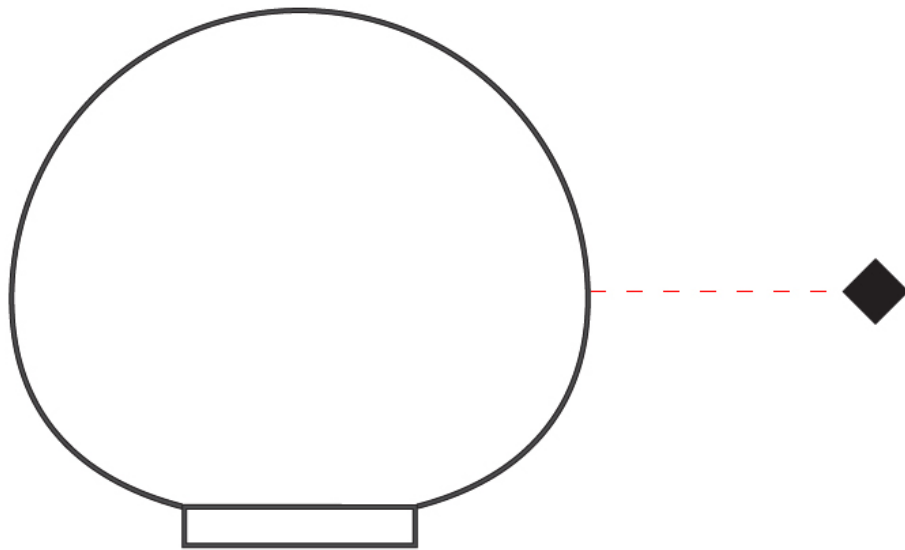

D

EMISFERO PORTABLE

D44003

base number

1. To build a product code in our configurator select the specify button on the base model # product page
2. To build a manual product code on this datasheet choose from the options listed below in blue font and add the suffix to the base model #

GENERAL

Series: Emisfero
Partner: Icone
Division: Design
Installation: Portable
Product Type: Table
Mounting Location: Floor
Light Distribution: Direct

PHYSICAL

Shape: Abstract
Diameter (mm): 480
Diameter (in): 18 7/8
Weight (kg): 6.6
Weight (lbs): 14.599
Diffuser: White - Hand Blown Triplex multi Layer Glass
Fixture Material: Aluminum
Primary Material: Glass
Upon Request: Bolt Down

ELECTRICAL

Number of Lamps: 1
Lamp Type: LED Retrofit
Lamp Shape: A19
Bulb Included: Bulb Not Included
Max. Wattage Per Lamp (W): 24
Lamp Base: E26
Input Voltage (V): 120
Upon Request: 277Vac / GU24

LED

OPTICAL

RATINGS AND CERTIFICATIONS

Certified By: CSA Certified to UL and CSA Standards
IP rating: IP20

PROJECT	_____
TYPE	_____
SPECIFIER	_____
QUANTITY	_____
DATE	_____

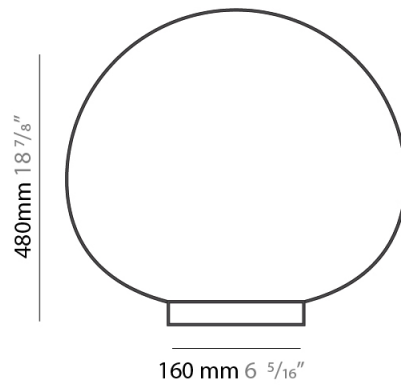

D44003

PROJECT

TYPE

SPECIFIER

QUANTITY

DATE

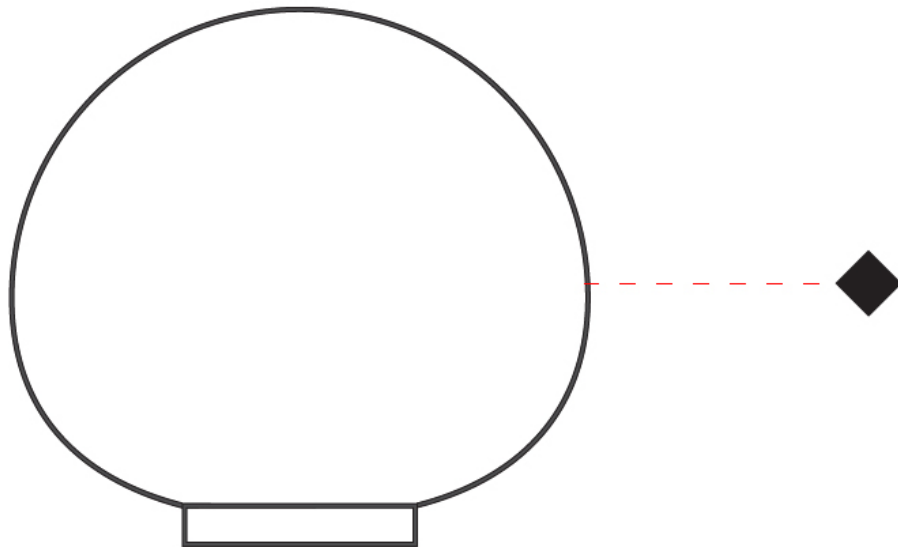

EMISFERO

COLOR FINISH CHART

PROJECT

TYPE

SPECIFIER

QUANTITY

DATE

Fixture Finish

Matte White - MWH

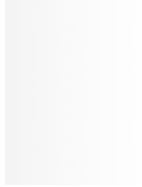





































































Holder Finish

Digital: Not all screens are calibrated the same, and therefore, colors will appear differently between screens.











Physical: When texture is involved, there will be variations in color, character and tone within a product series and between product families.



LEGEND

	floor-mounted		pivotal		special LED (upon request) RGB, RGBW, tunable, gold+, meat+, art+, fashion+
	wall and ceiling: recessed and surface mounted		rotating		warm dim / natural dimming LED
	ceiling-mounted and wall-mounted		illuminate tilted		rechargeable battery powered
	wall-mounted		color of suspension cable		fixture with natural vivid LED (upon request)
	omni-directional light distribution		length of suspension cable		color rendering index
	direct light distribution		reflector degree selection		color temperature
	direct/indirect light distribution		super spot		lumen (luminous flux)
	indirect light distribution		lens		efficacy (lumens per watt)
	asymmetric light distribution		lens pack		Unified Glare Rating (UGR) range from 5-40
	aura light distribution		shine ring		marine grade (AISI 316 stainless steel)
	round wall or ceiling cut-out		integrated shine ring with diffuser		walk on
	square wall or ceiling cut-out		free individual colors 01-29		drive on
	the supplied jig specifies the cutout dimensions		individual colors: 00 (free of charge), 01-25 (extra charge)		Dark Sky Compliance
	minimum distance (meters) lamp - object		luminaire part to be colored (F1)		Americans with Disabilities Act (less than 4" off the wall located between 27"-84" from floor)
	recessed depth		luminaire part to be colored (F2)		lamp protected against explosion
	ceiling thickness in mm		luminaire part to be colored (F3)		blown glass using traditional methods by master glass blower
	ceiling thickness selection		luminaire part to be colored (F4)		acoustic material
	dimnable DP (phase), DV (0-10V), DD (dali), DS (step-dim)		luminaire part to be colored (F5)		protection class I, protection insulation
	included or excluded LED driver/transformer/control gear		color of 3-circuit adaptor		protection class II, protection insulation
	separately switchable		indirect diffuser		ETL Certified to UL and CSA Standards
	sensor		direct diffuser		UL Certified to UL and CSA Standards
	remote control		ball-proof (upon request)		CSA Certified to UL and CSA Standards
	available upon request		accessory		Certified for North American Standards

IP RATING

	protected against ingress of solid bodies greater than 12.5mm (finger)
	protected against ingress of solid bodies greater than 2.5mm protected against sprays of water up to 60 degrees from the vertical (rain)
	protected against ingress of solid bodies greater than 1mm (wire) no protection against the ingress of moisture
	protected against ingress of solid bodies greater than 1mm (wire) protected against sprays of water up to 60 degrees from the vertical (rain)
	protected against ingress of solid bodies greater than 1mm (wire) protected against water splashed from all directions
	protected against limited ingress of dust (wet rooms/covered outdoor areas) protected against water splashed from all directions
	protected against ingress of dust protected against jets of water
	protected against ingress of dust protected against powerful jets of water or heavy seas
	protected against ingress of dust protected against immersion of water between 15cm - 1m for 30 minutes
	protected against ingress of dust protected against immersion of water under pressure for long periods

IK RATING

	protected against 0.14 joules impact (equivalent to 0.25kg mass dropped from 56mm above the surface)
	protected against 0.2 joules impact (equivalent to 0.25kg mass dropped from 80mm above the surface)
	protected against 0.35 joules impact (equivalent to 0.25kg mass dropped from 140mm above the surface)
	protected against 0.5 joules impact (equivalent to 0.25kg mass dropped from 200mm above the surface)
	protected against 0.7 joules impact (equivalent to 0.25kg mass dropped from 280mm above the surface)
	protected against 1 joules impact (equivalent to 0.25kg mass dropped from 400mm above the surface)
	protected against 2 joules impact (equivalent to 0.5kg mass dropped from 400mm above the surface)
	protected against 5 joules impact (equivalent to 1.7kg mass dropped from 300mm above the surface)
	protected against 10 joules impact (equivalent to 5.0kg mass dropped from 200mm above the surface)
	protected against 20 joules impact (equivalent to 5.0kg mass dropped from 400mm above the surface)