

PROJECT _____
 TYPE _____
 SPECIFIER _____
 QUANTITY _____
 DATE _____

ETEREA PORTABLE

E9B224-

base number _____
 Finish Options _____

- To build a product code in our configurator select the specify button on the base model # product page
- To build a manual product code on this datasheet choose from the options listed below in blue font and add the suffix to the base model #

GENERAL

Series: Eterea _____
 Brand: Platek _____
 Division: Exterior _____
 Mounting Type: Portable _____
 Mounting Location: Table _____
 Subcategory: Battery Operated _____

PHYSICAL

Shape: Rectangle _____
 Length (mm): 150 _____
 Length (in): 5 ⁷/₈ _____
 Width (mm): 150 _____
 Width (in): 5 ⁷/₈ _____
 Height (mm): 300 _____
 Height (in): 11 ¹³/₁₆ _____
 Light Distribution: Direct _____
 Weight (kg): 1.8 _____
 Weight (lbs): 4 _____
 Screws: No visible screws _____
 Diffuser: Frosted Methacrylate _____
 Fixture Finish: [ANT](#) / [BLK](#) / [BRZ](#) / [COR](#) / [RSB](#) / [WHI](#) _____
 Fixture Material: Stainless Steel _____
 Cable Details: Supplied with one Micro USB power supply cable 1.2m in length _____
 Upon Request: Bolt Down _____

ELECTRICAL

Lamp Type: LED _____
 Input Wattage (W): 4.5 _____
 Total Output Wattage (W): 4.5 _____
 Dimming: Non-Dimmable _____
 Input Voltage (V): 120 _____

LED

Number of LEDs: 1 _____
 Color Temperature (°K): 3000 _____
 Max. Delivered Lumen (lm): 275 _____
 Nominal Lumen (lm): 450 _____
 CRI: >90 CRI _____
 Lamp Life (hrs): 60000 _____

OPTICAL

Optic°: 100 _____

RATINGS AND CERTIFICATIONS

Certified By: Certified for North American Standards _____
 IP rating: IP65 _____
 IK Rating: IK07 _____
 Bug Rating: B0 U0 G0 _____
 Upon Request: Higher Maximum Ambient Temperature _____

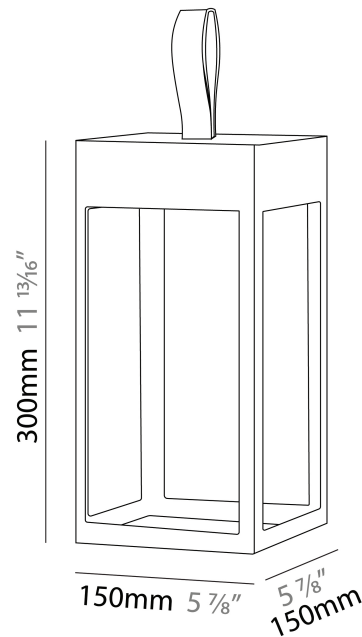

ETEREA PORTABLE

E9B224-

PROJECT

TYPE

SPECIFIER

QUANTITY

DATE



E

ETEREA PORTABLE

E9B268-

PROJECT _____

TYPE _____

SPECIFIER _____

QUANTITY _____

DATE _____



E

ETEREA PORTABLE

E9B300-

base number Finish
Options

- To build a product code in our configurator select the specify button on the base model # product page
- To build a manual product code on this datasheet choose from the options listed below in blue font and add the suffix to the base model #

GENERAL

Series: Eterea
Brand: Platek
Division: Exterior
Mounting Type: Portable
Mounting Location: Table
Subcategory: Battery Operated

PHYSICAL

Shape: Rectangle
Length (mm): 100
Length (in): 3 ¹⁵/₁₆
Width (mm): 100
Width (in): 3 ¹⁵/₁₆
Height (mm): 200
Height (in): 7 ⁷/₈
Light Distribution: Direct
Weight (kg): 0.9
Screws: No visible screws
Diffuser: Frosted Methacrylate
[Fixture Finish: ANT / BLK / BRZ / COR / RSB / WHI](#)
Fixture Material: Stainless Steel
Cable Details: Supplied with one Micro USB power supply cable 1.2m in length
Upon Request: Bolt Down

ELECTRICAL

Lamp Type: LED
Input Wattage (W): 1
Total Output Wattage (W): 1
Dimming: Non-Dimmable
Input Voltage (V): 120

LED

Number of LEDs: 1
Color Temperature (°K): 3000
Max. Delivered Lumen (lm): 80
Nominal Lumen (lm): 250
CRI: >90 CRI
Lamp Life (hrs): 60000

OPTICAL

Optic°: 100

RATINGS AND CERTIFICATIONS

Certified By: Certified for North American Standards
IP rating: IP65
IK Rating: IK07
Upon Request: Higher Maximum Ambient Temperature

PROJECT
TYPE
SPECIFIER
QUANTITY
DATE

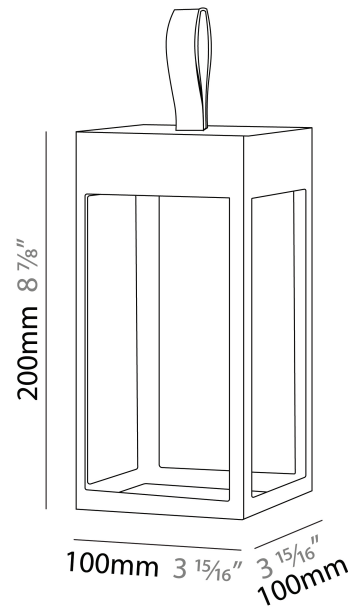

ETEREA PORTABLE

E9B300-

PROJECT _____

TYPE _____

SPECIFIER _____

QUANTITY _____

DATE _____



E

PROJECT _____

TYPE _____

SPECIFIER _____

QUANTITY _____

DATE _____

Fixture Finish

Anthracite - ANT



Black - BLK

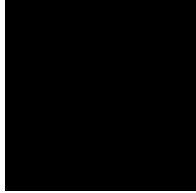

Bronze - BRZ

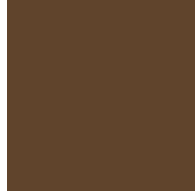

Corten - COR



White - WHI



Digital: Not all screens are calibrated the same, and therefore, colors will appear differently between screens.

Physical: When texture is involved, there will be variations in color, character and tone within a product series and between product families.













PROJECT	
TYPE	
SPECIFIER	
QUANTITY	
DATE	











LEGEND

 floor-mounted	 pivotable	 special LED (upon request) RGB, RGBW, tunable, gold+, meat+, art+, fashion+
 wall and ceiling: recessed and surface mounted	 rotating	 warm dim / natural dimming LED
 ceiling-mounted and wall-mounted	 illuminate tilted	 rechargeable battery powered
 wall-mounted	 color of suspension cable	 fixture with natural vivid LED (upon request)
 omni-directional light distribution	 length of suspension cable	 color rendering index
 direct light distribution	 reflector degree selection	 color temperature
 direct/indirect light distribution	 super spot	 lumen (luminous flux)
 indirect light distribution	 lens	 efficacy (lumens per watt)
 asymmetric light distribution	 lens pack	 Unified Glare Rating (UGR) range from 5-40
 aura light distribution	 shine ring	 marine grade (AISI 316 stainless steel)
 round wall or ceiling cut-out	 integrated shine ring with diffuser	 walk on
 square wall or ceiling cut-out	 free individual colors 01-29	 drive on
 the supplied jig specifies the cutout dimensions	 individual colors: 00 (free of charge), 01-25 (extra charge)	 Dark Sky Compliance
 minimum distance (meters) lamp - object	 luminaire part to be colored (F1)	 Americans with Disabilities Act (less than 4" off the wall located between 27"-84" from floor)
 recessed depth	 luminaire part to be colored (F2)	 lamp protected against explosion
 ceiling thickness in mm	 luminaire part to be colored (F3)	 blown glass using traditional methods by master glass blower
 ceiling thickness selection	 luminaire part to be colored (F4)	 acoustic material
 dimmable DP (phase), DV (0-10V), DD (dali), DS (step-dim)	 luminaire part to be colored (F5)	 protection class I, protection insulation
 included or excluded LED driver/transformer/control gear	 color of 3-circuit adaptor	 protection class II, protection insulation
 separately switchable	 indirect diffuser	 ETL Certified to UL and CSA Standards
 sensor	 direct diffuser	 UL Certified to UL and CSA Standards
 remote control	 ball-proof (upon request)	 CSA Certified to UL and CSA Standards
 available upon request	 accessory	 Certified for North American Standards

IP RATING

 IP20	protected against ingress of solid bodies greater than 12.5mm (finger)
 IP33	protected against ingress of solid bodies greater than 2.5mm protected against sprays of water up to 60 degrees from the vertical (rain)
 IP40	protected against ingress of solid bodies greater than 1mm (wire) no protection against the ingress of moisture
 IP43	protected against ingress of solid bodies greater than 1mm (wire) protected against sprays of water up to 60 degrees from the vertical (rain)
 IP44	protected against ingress of solid bodies greater than 1mm (wire) protected against water splashed from all directions
 IP54	protected against limited ingress of dust (wet rooms/covered outdoor areas) protected against water splashed from all directions
 IP65	protected against ingress of dust protected against jets of water
 IP66	protected against ingress of dust protected against powerful jets of water or heavy seas
 IP67	protected against ingress of dust protected against immersion of water between 15cm - 1m for 30 minutes
 IP68	protected against ingress of dust protected against immersion of water under pressure for long periods

IK RATING

 IK01	protected against 0.14 joules impact (equivalent to 0.25kg mass dropped from 56mm above the surface)
 IK02	protected against 0.2 joules impact (equivalent to 0.25kg mass dropped from 80mm above the surface)
 IK03	protected against 0.35 joules impact (equivalent to 0.25kg mass dropped from 140mm above the surface)
 IK04	protected against 0.5 joules impact (equivalent to 0.25kg mass dropped from 200mm above the surface)
 IK05	protected against 0.7 joules impact (equivalent to 0.25kg mass dropped from 280mm above the surface)
 IK06	protected against 1 joules impact (equivalent to 0.25kg mass dropped from 400mm above the surface)
 IK07	protected against 2 joules impact (equivalent to 0.5kg mass dropped from 400mm above the surface)
 IK08	protected against 5 joules impact (equivalent to 1.7kg mass dropped from 300mm above the surface)
 IK09	protected against 10 joules impact (equivalent to 5.0kg mass dropped from 200mm above the surface)
 IK10	protected against 20 joules impact (equivalent to 5.0kg mass dropped from 400mm above the surface)