

EXCENTRICA SUSPENSION

D51020-

base number Finish
Options

- To build a product code in our configurator select the specify button on the base model # product page
- To build a manual product code on this datasheet choose from the options listed below in blue font and add the suffix to the base model #

GENERAL

Series: Excentrica
 Brand: Fambuena
 Division: Design
 Mounting Type: Suspension
 Mounting Location: Ceiling
 Subcategory: Pendant

PHYSICAL

Shape: Cylinder
 Diameter (mm): 400
 Diameter (in): 15 3/4
 Height (mm): 240
 Height (in): 9 7/16
 Max. Overall Height (mm): 2240
 Max. Overall Height (in): 88 3/16
 Light Distribution: Direct
 Diffuser: Cotton Shade
 Fixture Finish: WHI / BLK / BRA / PWT
 Fixture Material: Metal
 Cable Details: Cable length 2000mm / 79"

ELECTRICAL

Number of Lamps: 1
 Lamp Type: LED Retrofit
 Lamp Shape: A19
 Bulb Included: Bulb Not Included
 Max. Wattage Per Lamp (W): 7
 Lamp Base: E26
 Input Voltage (V): 120
 Upon Request: 277Vac / GU24

LED

OPTICAL

RATINGS AND CERTIFICATIONS

Certified By: Certified for North American Standards
 IP rating: IP20

PROJECT	_____
TYPE	_____
SPECIFIER	_____
QUANTITY	_____
DATE	_____

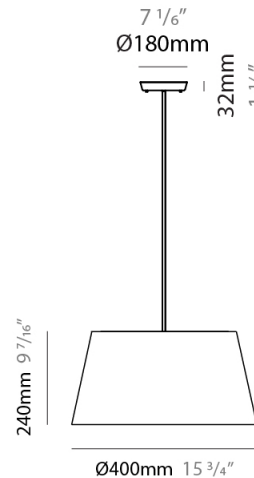

EXCENTRICA SUSPENSION

D51020-

PROJECT

TYPE

SPECIFIER

QUANTITY

DATE

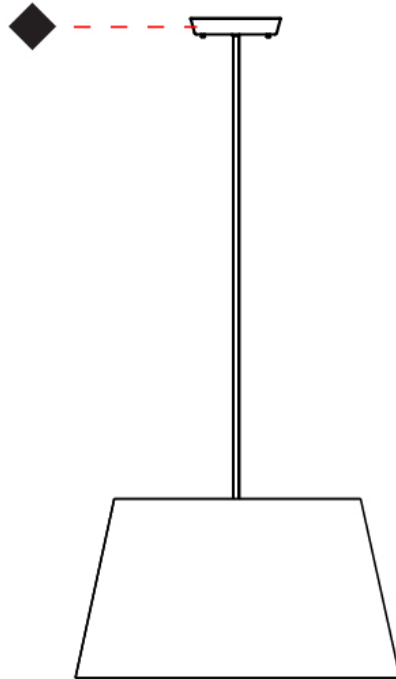

EXCENTRICA SUSPENSION

D51021-

base number Finish
Options

- To build a product code in our configurator select the specify button on the base model # product page
- To build a manual product code on this datasheet choose from the options listed below in blue font and add the suffix to the base model #

GENERAL

Series: Excentrica
Brand: Fambuena
Division: Design
Mounting Type: Suspension
Mounting Location: Ceiling
Subcategory: Ambient

PHYSICAL

Shape: Cylinder
Diameter (mm): 650
Diameter (in): 25 ⁹/₁₆"
Height (mm): 650
Height (in): 25 ⁹/₁₆"
Max. Overall Height (mm): 2650
Max. Overall Height (in): 104 ⁵/₁₆"
Light Distribution: Direct
Diffuser: Cotton Shade
Fixture Finish: WHI / BLK / BRA / PWT
Fixture Material: Metal
Cable Details: Cable length 2000mm / 79"

ELECTRICAL

Number of Lamps: 1
Lamp Type: LED Retrofit
Lamp Shape: A19
Bulb Included: Bulb Not Included
Max. Wattage Per Lamp (W): 12
Lamp Base: E26
Input Voltage (V): 120
Upon Request: 277Vac / GU24

LED

OPTICAL

RATINGS AND CERTIFICATIONS

Certified By: Certified for North American Standards
IP rating: IP20

PROJECT
TYPE
SPECIFIER
QUANTITY
DATE

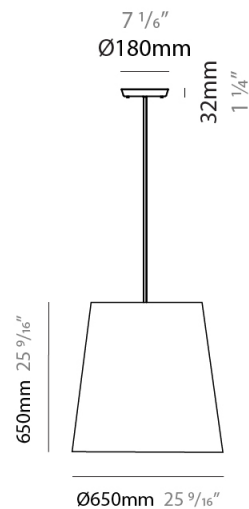

EXCENTRICA SUSPENSION

D51021-

PROJECT

TYPE

SPECIFIER

QUANTITY

DATE

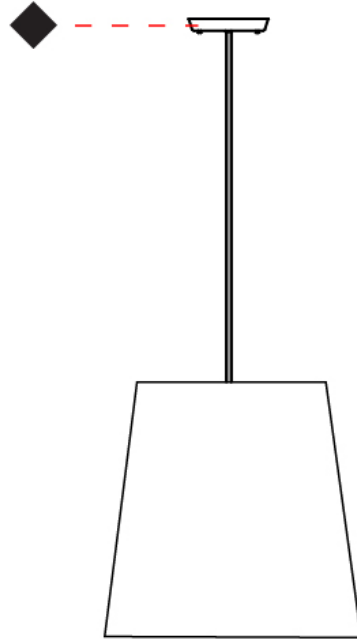

D

PROJECT
TYPE
SPECIFIER
QUANTITY
DATE

EXCENTRICA SURFACE

D53011-

base number Finish
Options

- To build a product code in our configurator select the specify button on the base model # product page
- To build a manual product code on this datasheet choose from the options listed below in blue font and add the suffix to the base model #

GENERAL

Series: Excentrica
 Brand: Fambuena
 Division: Design
 Mounting Type: Surface
 Mounting Location: Wall
 Subcategory: Ambient

PHYSICAL

Shape: Cylinder
 Diameter (mm): 230
 Diameter (in): 9 1/16
 Height (mm): 270
 Height (in): 10 5/8
 Extension (mm): 320
 Extension (in): 12 5/8
 Light Distribution: Direct
 Diffuser: Cotton Shade
 Fixture Finish: WHI / BLK / BRA / PWT
 Fixture Material: Metal

ELECTRICAL

Number of Lamps: 1
 Lamp Type: LED Retrofit
 Lamp Shape: B10
 Bulb Included: Bulb Not Included
 Max. Wattage Per Lamp (W): 4
 Lamp Base: E12
 Input Voltage (V): 120

LED

OPTICAL

RATINGS AND CERTIFICATIONS

Certified By: Certified for North American Standards
 IP rating: IP20

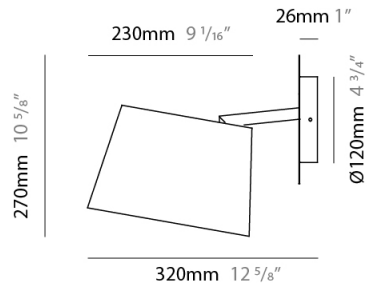

D53011-

PROJECT

TYPE

SPECIFIER

QUANTITY

DATE

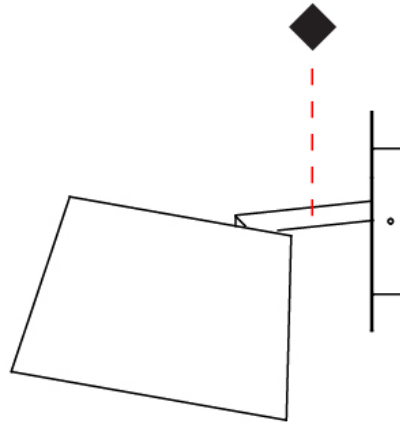

EXCENTRICA PORTABLE

D54006-

base number Finish
Options

PROJECT	_____
TYPE	_____
SPECIFIER	_____
QUANTITY	_____
DATE	_____

- To build a product code in our configurator select the specify button on the base model # product page
- To build a manual product code on this datasheet choose from the options listed below in blue font and add the suffix to the base model #

GENERAL

Series: Excentrica _____
 Brand: Fambuena _____
 Division: Design _____
 Mounting Type: Portable _____
 Mounting Location: Table _____
 Subcategory: Table _____

PHYSICAL

Shape: Cylinder _____
 Diameter (mm): 380 _____
 Diameter (in): 14 ¹⁵/₁₆ _____
 Height (mm): 700 _____
 Height (in): 27 ⁹/₁₆ _____
 Light Distribution: Direct _____
 Diffuser: Cotton Shade _____
 Fixture Finish: WHI / BLK _____
 Fixture Material: Metal _____
 Upon Request: Bolt Down _____

ELECTRICAL

Number of Lamps: 1 _____
 Lamp Type: LED Retrofit _____
 Lamp Shape: A19 _____
 Bulb Included: Bulb Not Included _____
 Max. Wattage Per Lamp (W): 7 _____
 Lamp Base: E26 _____
 Input Voltage (V): 120 _____
 Upon Request: 277Vac / GU24 _____

LED

OPTICAL

RATINGS AND CERTIFICATIONS

Certified By: Certified for North American Standards _____
 IP rating: IP20 _____

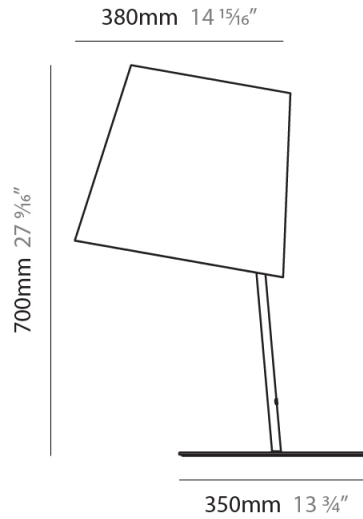

D54006-

PROJECT

TYPE

SPECIFIER

QUANTITY

DATE

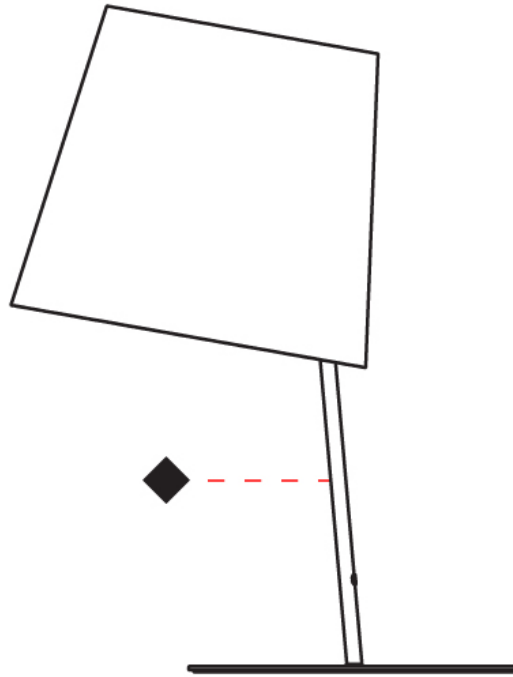

EXCENTRICA PORTABLE

D54007-

base number Finish
Options

- To build a product code in our configurator select the specify button on the base model # product page
- To build a manual product code on this datasheet choose from the options listed below in blue font and add the suffix to the base model #

GENERAL

Series: Excentrica
Brand: Fambuena
Division: Design
Mounting Type: Portable
Mounting Location: Table
Subcategory: Table

PHYSICAL

Shape: Cylinder
Diameter (mm): 230
Diameter (in): 9 1/16
Height (mm): 440
Height (in): 17 5/16
Light Distribution: Direct
Diffuser: Cotton Shade
Fixture Finish: WHI / BLK
Holder Finish: WHI / BLK
Fixture Material: Metal
Upon Request: Bolt Down

ELECTRICAL

Number of Lamps: 1
Lamp Type: LED Retrofit
Lamp Shape: B10
Bulb Included: Bulb Not Included
Max. Wattage Per Lamp (W): 4
Lamp Base: E12
Input Voltage (V): 120

LED

OPTICAL

RATINGS AND CERTIFICATIONS

Certified By: Certified for North American Standards
IP rating: IP20

PROJECT
TYPE
SPECIFIER
QUANTITY
DATE

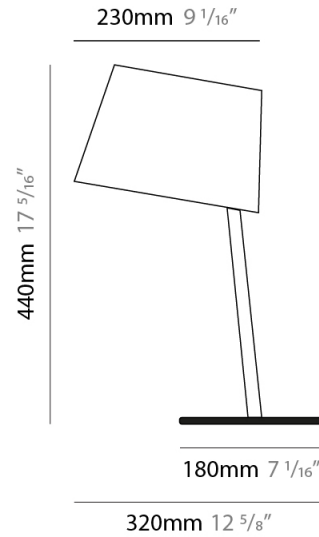

D54007-

PROJECT	_____
TYPE	_____
SPECIFIER	_____
QUANTITY	_____
DATE	_____

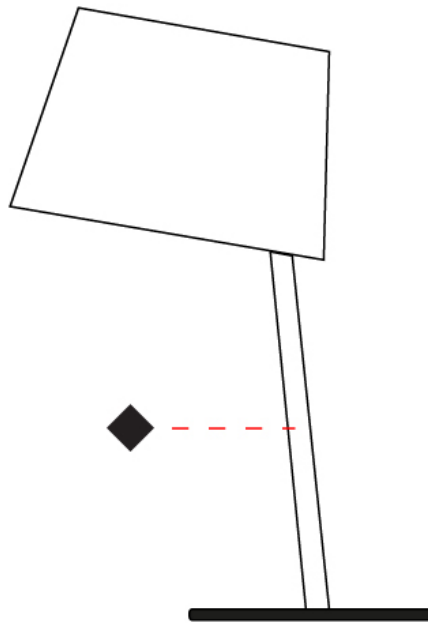

EXCENTRICA PORTABLE

D54008-

base number Finish
Options

PROJECT	_____
TYPE	_____
SPECIFIER	_____
QUANTITY	_____
DATE	_____

- To build a product code in our configurator select the specify button on the base model # product page
- To build a manual product code on this datasheet choose from the options listed below in blue font and add the suffix to the base model #

GENERAL

Series: Excentrica
 Brand: Fambuena
 Division: Design
 Mounting Type: Portable
 Mounting Location: Table
 Subcategory: Table

PHYSICAL

Shape: Cylinder
 Diameter (mm): 230
 Diameter (in): 9 1/16
 Height (mm): 510
 Height (in): 20 1/16
 Extension (mm): 740
 Extension (in): 29 1/8
 Light Distribution: Direct
 Diffuser: Cotton Shade
 Fixture Finish: WHI / BLK
 Holder Finish: WHI / BLK
 Fixture Material: Metal
 Upon Request: Bolt Down

ELECTRICAL

Number of Lamps: 1
 Lamp Type: LED Retrofit
 Lamp Shape: B10
 Bulb Included: Bulb Not Included
 Max. Wattage Per Lamp (W): 4
 Lamp Base: E12
 Input Voltage (V): 120

LED

OPTICAL

RATINGS AND CERTIFICATIONS

Certified By: Certified for North American Standards
 IP rating: IP20

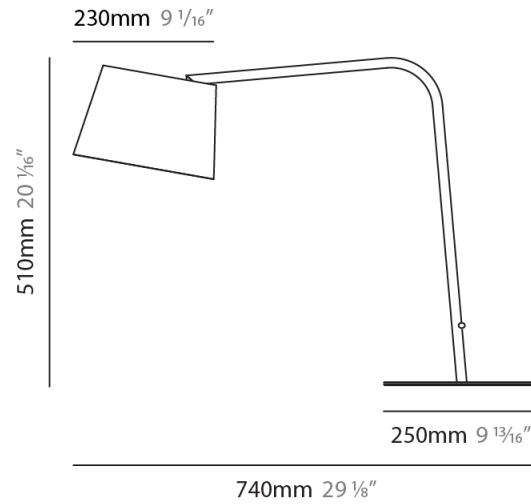

D54008-

PROJECT _____

TYPE _____

SPECIFIER _____

QUANTITY _____

DATE _____

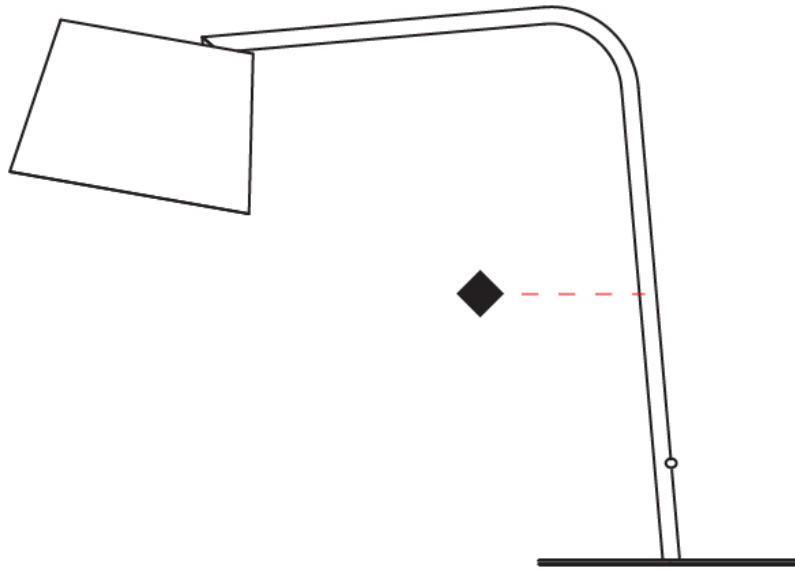

D

EXCENTRICA PORTABLE

D54009-

base number Finish
Options

PROJECT
TYPE
SPECIFIER
QUANTITY
DATE

- To build a product code in our configurator select the specify button on the base model # product page
- To build a manual product code on this datasheet choose from the options listed below in blue font and add the suffix to the base model #

GENERAL

Series: Excentrica
 Brand: Fambuena
 Division: Design
 Mounting Type: Portable
 Mounting Location: Floor
 Subcategory: Floor

PHYSICAL

Shape: Abstract
 Diameter (mm): 380
 Diameter (in): 14 ¹⁵/₁₆
 Height (mm): 1700
 Height (in): 66 ¹⁵/₁₆
 Light Distribution: Direct
 Diffuser: Cotton Shade
 Fixture Finish: WHI / BLK
 Holder Finish: WHI / BLK
 Fixture Material: Metal
 Upon Request: Bolt Down

ELECTRICAL

Number of Lamps: 1
 Lamp Type: LED Retrofit
 Lamp Shape: A19
 Bulb Included: Bulb Not Included
 Max. Wattage Per Lamp (W): 12
 Lamp Base: E26
 Input Voltage (V): 120
 Upon Request: 277Vac / GU24

LED

OPTICAL

RATINGS AND CERTIFICATIONS

Certified By: Certified for North American Standards
 IP rating: IP20

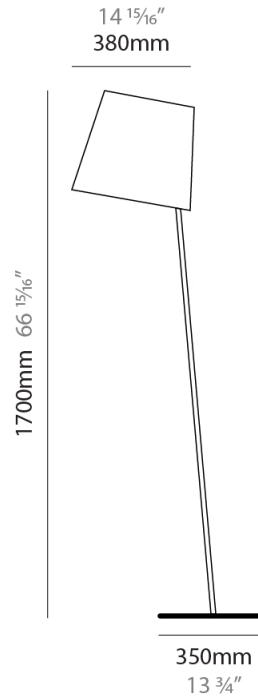

D54009-

PROJECT _____

TYPE _____

SPECIFIER _____

QUANTITY _____

DATE _____

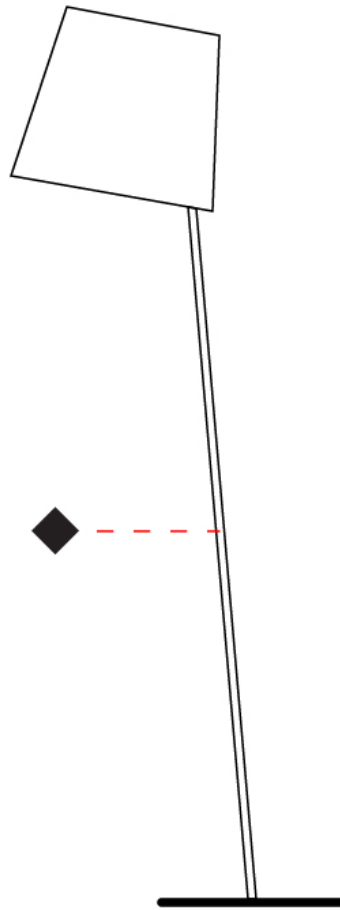

EXCENTRICA PORTABLE

D54010-

base number Finish
Options

PROJECT	_____
TYPE	_____
SPECIFIER	_____
QUANTITY	_____
DATE	_____

- To build a product code in our configurator select the specify button on the base model # product page
- To build a manual product code on this datasheet choose from the options listed below in blue font and add the suffix to the base model #

GENERAL

Series: Excentrica
 Brand: Fambuena
 Division: Design
 Mounting Type: Portable
 Mounting Location: Floor
 Subcategory: Floor

PHYSICAL

Shape: Abstract
 Diameter (mm): 380
 Diameter (in): 14 ¹⁵/₁₆
 Height (mm): 1840
 Height (in): 72 ⁷/₁₆
 Extension (mm): 1920
 Extension (in): 75 ⁹/₁₆
 Light Distribution: Direct
 Diffuser: Cotton Shade
 Fixture Finish: WHI / BLK
 Holder Finish: WHI / BLK
 Fixture Material: Metal
 Upon Request: Bolt Down

ELECTRICAL

Number of Lamps: 1
 Lamp Type: LED Retrofit
 Lamp Shape: A19
 Bulb Included: Bulb Not Included
 Max. Wattage Per Lamp (W): 12
 Lamp Base: E26
 Input Voltage (V): 120
 Upon Request: 277Vac / GU24

LED

OPTICAL

RATINGS AND CERTIFICATIONS

Certified By: Certified for North American Standards
 IP rating: IP20

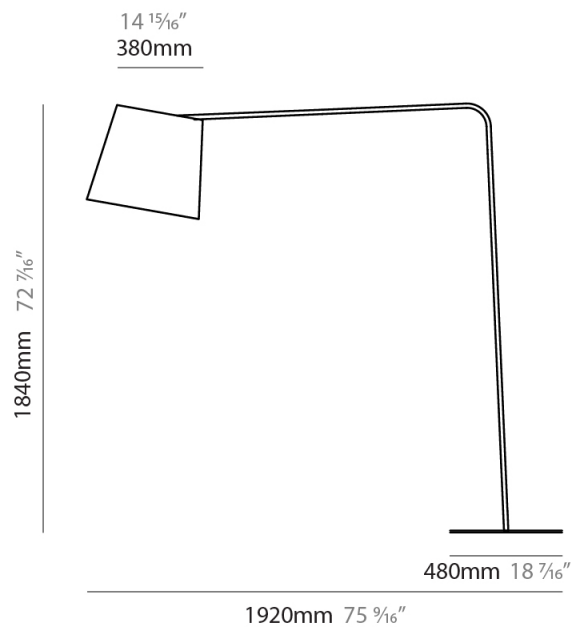

D54010-

PROJECT

TYPE

SPECIFIER

QUANTITY

DATE

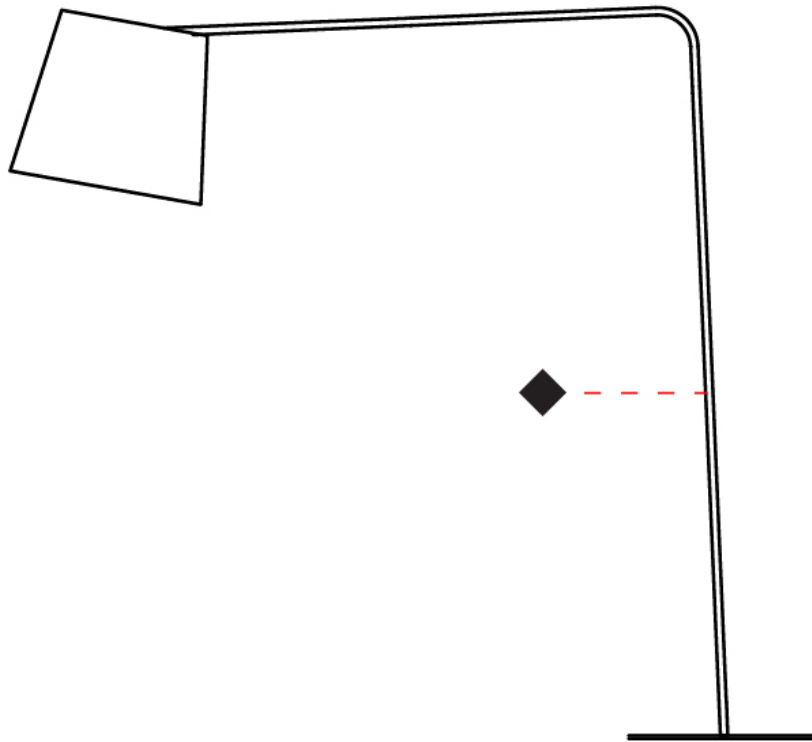

PROJECT
TYPE
SPECIFIER
QUANTITY
DATE

EXCENTRICA PORTABLE

D54046- -
 base number Finish Options Finish Options

- To build a product code in our configurator select the specify button on the base model # product page
- To build a manual product code on this datasheet choose from the options listed below in blue font and add the suffix to the base model #

GENERAL

Series: Excentrica
 Brand: Fambuena
 Division: Design
 Mounting Type: Portable
 Mounting Location: Table
 Subcategory: Table

PHYSICAL

Shape: Cylinder
 Diameter (mm): 380
 Diameter (in): 14 ¹⁵/₁₆
 Height (mm): 700
 Height (in): 27 ⁹/₁₆
 Light Distribution: Direct
 Diffuser: Cotton Shade
 Fixture Finish: [BRA / PWT](#)
 Holder Finish: [BLM / WHM](#)
 Fixture Material: Metal / Marble
 Upon Request: Bolt Down

ELECTRICAL

Number of Lamps: 1
 Lamp Type: LED Retrofit
 Lamp Shape: A19
 Bulb Included: Bulb Not Included
 Max. Wattage Per Lamp (W): 7
 Lamp Base: E26
 Input Voltage (V): 120
 Upon Request: 277Vac / GU24

LED

OPTICAL

RATINGS AND CERTIFICATIONS

Certified By: Certified for North American Standards
 IP rating: IP20

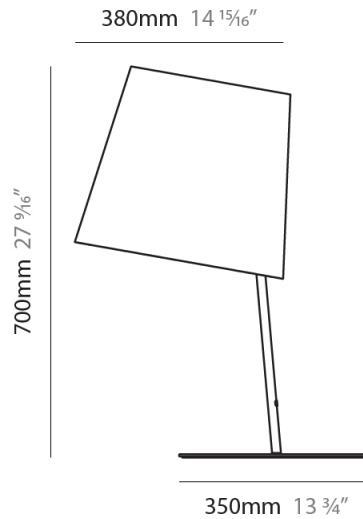

D54046-

PROJECT	_____
TYPE	_____
SPECIFIER	_____
QUANTITY	_____
DATE	_____

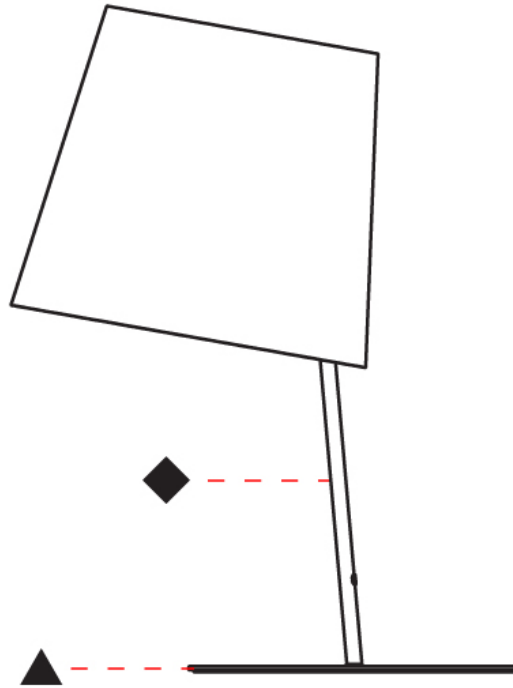

EXCENTRICA PORTABLE

D54047- -

base number Finish Options Finish Options

- To build a product code in our configurator select the specify button on the base model # product page
- To build a manual product code on this datasheet choose from the options listed below in blue font and add the suffix to the base model #

GENERAL

Series: Excentrica
 Brand: Fambuena
 Division: Design
 Mounting Type: Portable
 Mounting Location: Table
 Subcategory: Table

PHYSICAL

Shape: Cylinder
 Diameter (mm): 230
 Diameter (in): 9 1/16
 Height (mm): 440
 Height (in): 17 5/16
 Light Distribution: Direct
 Diffuser: Cotton Shade
 Fixture Finish: [BRA / PWT](#)
 Holder Finish: [BLM / WHM](#)
 Fixture Material: Metal / Marble
 Upon Request: Bolt Down

ELECTRICAL

Number of Lamps: 1
 Lamp Type: LED Retrofit
 Lamp Shape: B10
 Bulb Included: Bulb Not Included
 Max. Wattage Per Lamp (W): 4
 Lamp Base: E12
 Input Voltage (V): 120

LED

OPTICAL

RATINGS AND CERTIFICATIONS

Certified By: Certified for North American Standards
 IP rating: IP20

PROJECT
TYPE
SPECIFIER
QUANTITY
DATE

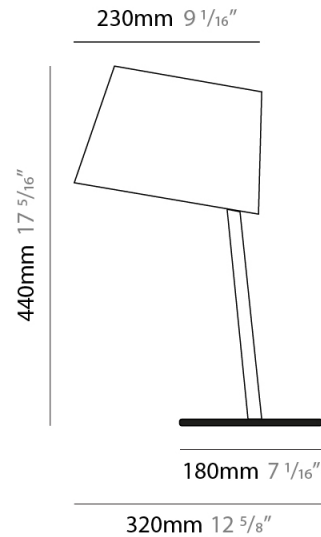

D54047-

PROJECT

TYPE

SPECIFIER

QUANTITY

DATE

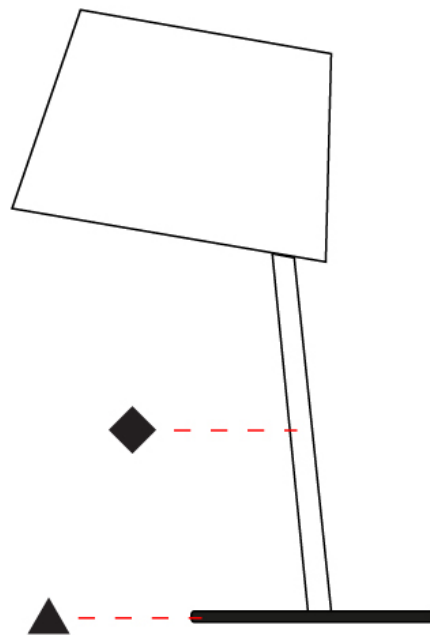

D

EXCENTRICA PORTABLE

D54048- -

base number Finish Options Finish Options

- To build a product code in our configurator select the specify button on the base model # product page
- To build a manual product code on this datasheet choose from the options listed below in blue font and add the suffix to the base model #

GENERAL

Series: Excentrica
 Brand: Fambuena
 Division: Design
 Mounting Type: Portable
 Mounting Location: Table
 Subcategory: Table

PHYSICAL

Shape: Cylinder
 Diameter (mm): 230
 Diameter (in): 9 1/16
 Height (mm): 510
 Height (in): 20 1/16
 Extension (mm): 740
 Extension (in): 29 1/8
 Light Distribution: Direct
 Diffuser: Cotton Shade
 Fixture Finish: [BRA / PWT](#)
 Holder Finish: [BLM / WHM](#)
 Fixture Material: Metal / Marble
 Upon Request: Bolt Down

ELECTRICAL

Number of Lamps: 1
 Lamp Type: LED Retrofit
 Lamp Shape: B10
 Bulb Included: Bulb Not Included
 Max. Wattage Per Lamp (W): 4
 Lamp Base: E12
 Input Voltage (V): 120

LED

OPTICAL

RATINGS AND CERTIFICATIONS

Certified By: Certified for North American Standards
 IP rating: IP20

PROJECT _____
 TYPE _____
 SPECIFIER _____
 QUANTITY _____
 DATE _____

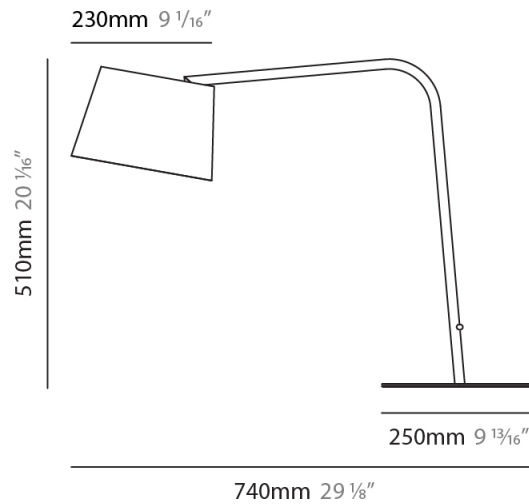

D54048-

PROJECT _____

TYPE _____

SPECIFIER _____

QUANTITY _____

DATE _____

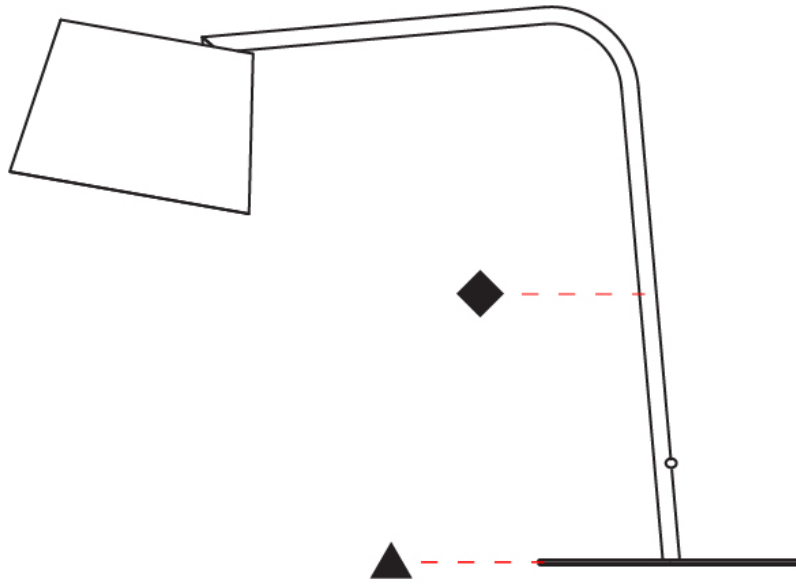

D

EXCENTRICA PORTABLE

D54049- _____ - _____

base number Finish Options Finish Options

- To build a product code in our configurator select the specify button on the base model # product page
- To build a manual product code on this datasheet choose from the options listed below in blue font and add the suffix to the base model #

GENERAL

Series: Excentrica
 Brand: Fambuena
 Division: Design
 Mounting Type: Portable
 Mounting Location: Floor
 Subcategory: Floor

PHYSICAL

Shape: Abstract
 Diameter (mm): 380
 Diameter (in): 14 ¹⁵/₁₆
 Height (mm): 1700
 Height (in): 66 ¹⁵/₁₆
 Light Distribution: Direct
 Diffuser: Cotton Shade
[Fixture Finish: BRA / PWT](#)
 Holder Finish: BLM / WHM
 Fixture Material: Metal / Marble
 Upon Request: Bolt Down

ELECTRICAL

Number of Lamps: 1
 Lamp Type: LED Retrofit
 Lamp Shape: A19
 Bulb Included: Bulb Not Included
 Max. Wattage Per Lamp (W): 12
 Lamp Base: E26
 Input Voltage (V): 120
 Upon Request: 277Vac / GU24

LED

OPTICAL

RATINGS AND CERTIFICATIONS

Certified By: Certified for North American Standards
 IP rating: IP20

PROJECT
TYPE
SPECIFIER
QUANTITY
DATE

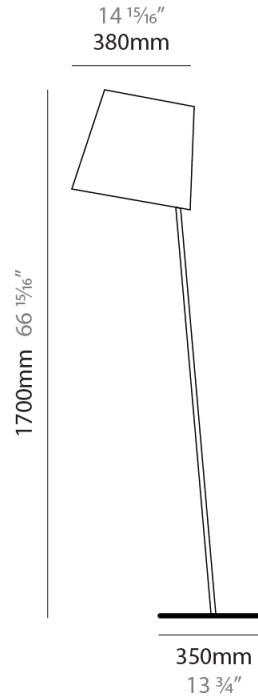

D54049-

PROJECT

TYPE

SPECIFIER

QUANTITY

DATE

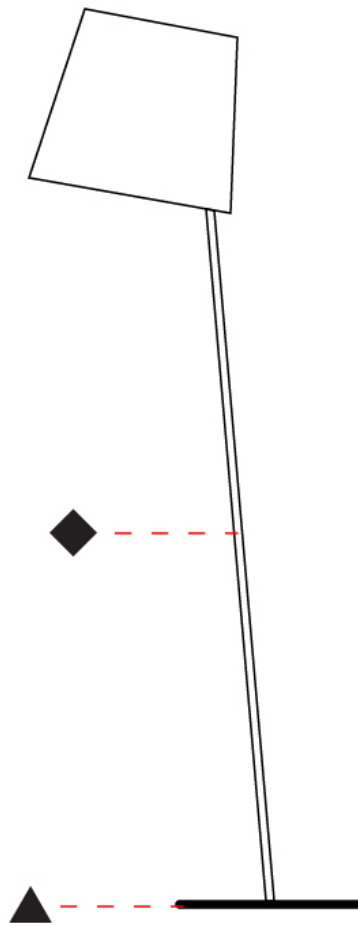

D

EXCENTRICA PORTABLE

D54051- _____ - _____

base number Finish Options Finish Options

- To build a product code in our configurator select the specify button on the base model # product page
- To build a manual product code on this datasheet choose from the options listed below in blue font and add the suffix to the base model #

GENERAL

Series: Excentrica
 Brand: Fambuena
 Division: Design
 Mounting Type: Portable
 Mounting Location: Floor
 Subcategory: Floor

PHYSICAL

Shape: Cylinder
 Diameter (mm): 230
 Diameter (in): 9 1/16
 Height (mm): 1350
 Height (in): 53 1/8
 Light Distribution: Direct
 Diffuser: Cotton Shade
 Fixture Finish: [BRA / PWT](#)
 Holder Finish: BLM / WHM
 Fixture Material: Metal / Marble

ELECTRICAL

Number of Lamps: 1
 Lamp Type: LED Retrofit
 Lamp Shape: B10
 Bulb Included: Bulb Not Included
 Max. Wattage Per Lamp (W): 4
 Lamp Base: E12
 Input Voltage (V): 120

LED

OPTICAL

RATINGS AND CERTIFICATIONS

Certified By: Certified for North American Standards
 IP rating: IP20

PROJECT
TYPE
SPECIFIER
QUANTITY
DATE

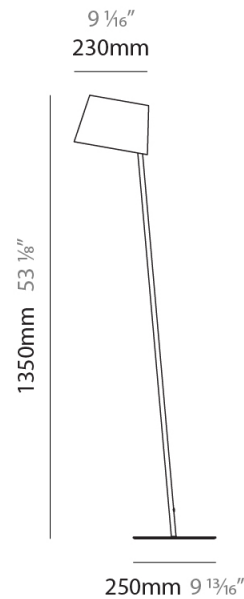

D54051-

PROJECT

TYPE

SPECIFIER

QUANTITY

DATE

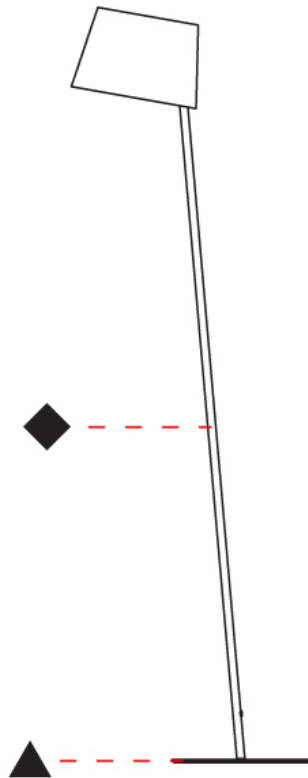

D

PROJECT	_____
TYPE	_____
SPECIFIER	_____
QUANTITY	_____
DATE	_____

Fixture Finish

White - WHI



Black - BLK

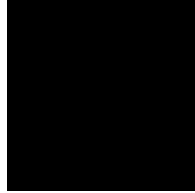

Brass - BRA



Pewter - PWT



Holder Finish

White - WHI



Black - BLK



Black Marble - BLM

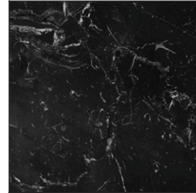

White Marble - WHM



Digital: Not all screens are calibrated the same, and therefore, colors will appear differently between screens.

Physical: When texture is involved, there will be variations in color, character and tone within a product series and between product families.



LEGEND

	floor-mounted		pivotal		special LED (upon request) RGB, RGBW, tunable, gold+, meat+, art+, fashion+
	wall and ceiling: recessed and surface mounted		rotating		warm dim / natural dimming LED
	ceiling-mounted and wall-mounted		illuminate tilted		rechargeable battery powered
	wall-mounted		color of suspension cable		fixture with natural vivid LED (upon request)
	omni-directional light distribution		length of suspension cable		color rendering index
	direct light distribution		reflector degree selection		color temperature
	direct/indirect light distribution		super spot		lumen (luminous flux)
	indirect light distribution		lens		efficacy (lumens per watt)
	asymmetric light distribution		lens pack		Unified Glare Rating (UGR) range from 5-40
	aura light distribution		shine ring		marine grade (AISI 316 stainless steel)
	round wall or ceiling cut-out		integrated shine ring with diffuser		walk on
	square wall or ceiling cut-out		free individual colors 01-29		drive on
	the supplied jig specifies the cutout dimensions		individual colors: 00 (free of charge), 01-25 (extra charge)		Dark Sky Compliance
	minimum distance (meters) lamp - object		luminaire part to be colored (F1)		Americans with Disabilities Act (less than 4" off the wall located between 27"-84" from floor)
	recessed depth		luminaire part to be colored (F2)		lamp protected against explosion
	ceiling thickness in mm		luminaire part to be colored (F3)		blown glass using traditional methods by master glass blower
	ceiling thickness selection		luminaire part to be colored (F4)		acoustic material
	dimmable DP (phase), DV (0-10V), DD (dali), DS (step-dim)		luminaire part to be colored (F5)		protection class I, protection insulation
	included or excluded LED driver/transformer/control gear		color of 3-circuit adaptor		protection class II, protection insulation
	separately switchable		indirect diffuser		ETL Certified to UL and CSA Standards
	sensor		direct diffuser		UL Certified to UL and CSA Standards
	remote control		ball-proof (upon request)		CSA Certified to UL and CSA Standards
	available upon request		accessory		Certified for North American Standards

IP RATING

	protected against ingress of solid bodies greater than 12.5mm (finger)
	protected against ingress of solid bodies greater than 2.5mm protected against sprays of water up to 60 degrees from the vertical (rain)
	protected against ingress of solid bodies greater than 1mm (wire) no protection against the ingress of moisture
	protected against ingress of solid bodies greater than 1mm (wire) protected against sprays of water up to 60 degrees from the vertical (rain)
	protected against ingress of solid bodies greater than 1mm (wire) protected against water splashed from all directions
	protected against limited ingress of dust (wet rooms/covered outdoor areas) protected against water splashed from all directions
	protected against ingress of dust protected against jets of water
	protected against ingress of dust protected against powerful jets of water or heavy seas
	protected against ingress of dust protected against immersion of water between 15cm - 1m for 30 minutes
	protected against ingress of dust protected against immersion of water under pressure for long periods

IK RATING

	protected against 0.14 joules impact (equivalent to 0.25kg mass dropped from 56mm above the surface)
	protected against 0.2 joules impact (equivalent to 0.25kg mass dropped from 80mm above the surface)
	protected against 0.35 joules impact (equivalent to 0.25kg mass dropped from 140mm above the surface)
	protected against 0.5 joules impact (equivalent to 0.25kg mass dropped from 200mm above the surface)
	protected against 0.7 joules impact (equivalent to 0.25kg mass dropped from 280mm above the surface)
	protected against 1 joules impact (equivalent to 0.25kg mass dropped from 400mm above the surface)
	protected against 2 joules impact (equivalent to 0.5kg mass dropped from 400mm above the surface)
	protected against 5 joules impact (equivalent to 1.7kg mass dropped from 300mm above the surface)
	protected against 10 joules impact (equivalent to 5.0kg mass dropped from 200mm above the surface)
	protected against 20 joules impact (equivalent to 5.0kg mass dropped from 400mm above the surface)