

EXCENTRICA SUSPENSION

D51020-

base number Finish
Options

- To build a product code in our configurator select the specify button on the base model # product page
- To build a manual product code on this datasheet choose from the options listed below in blue font and add the suffix to the base model #

GENERAL

Series: Excentrica
 Brand: Fambuena
 Division: Design
 Mounting Type: Suspension
 Mounting Location: Ceiling
 Subcategory: Pendant

PHYSICAL

Shape: Cylinder
 Diameter (mm): 400
 Diameter (in): 15 3/4
 Height (mm): 240
 Height (in): 9 7/16
 Max. Overall Height (mm): 2240
 Max. Overall Height (in): 88 3/16
 Light Distribution: Direct
 Diffuser: Cotton Shade
 Fixture Finish: WHI / BLK / BRA / PWT
 Fixture Material: Metal
 Cable Details: Cable length 2000mm / 79"

ELECTRICAL

Number of Lamps: 1
 Lamp Type: LED Retrofit
 Lamp Shape: A19
 Bulb Included: Bulb Not Included
 Max. Wattage Per Lamp (W): 7
 Lamp Base: E26
 Input Voltage (V): 120
 Upon Request: 277Vac / GU24

LED

OPTICAL

RATINGS AND CERTIFICATIONS

Certified By: Certified for North American Standards
 IP rating: IP20

PROJECT	_____
TYPE	_____
SPECIFIER	_____
QUANTITY	_____
DATE	_____

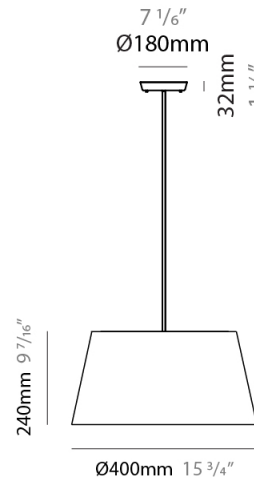

EXCENTRICA SUSPENSION

D51020-

PROJECT

TYPE

SPECIFIER

QUANTITY

DATE

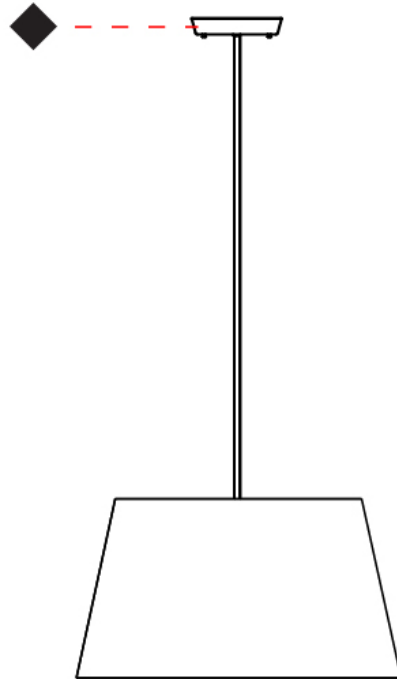

EXCENTRICA SUSPENSION

D51021-

base number Finish
Options

- To build a product code in our configurator select the specify button on the base model # product page
- To build a manual product code on this datasheet choose from the options listed below in blue font and add the suffix to the base model #

GENERAL

Series: Excentrica
 Brand: Fambuena
 Division: Design
 Mounting Type: Suspension
 Mounting Location: Ceiling
 Subcategory: Ambient

PHYSICAL

Shape: Cylinder
 Diameter (mm): 650
 Diameter (in): 25 ⁹/₁₆
 Height (mm): 650
 Height (in): 25 ⁹/₁₆
 Max. Overall Height (mm): 2650
 Max. Overall Height (in): 104 ⁵/₁₆
 Light Distribution: Direct
 Diffuser: Cotton Shade
 Fixture Finish: WHI / BLK / BRA / PWT
 Fixture Material: Metal
 Cable Details: Cable length 2000mm / 79"

ELECTRICAL

Number of Lamps: 1
 Lamp Type: LED Retrofit
 Lamp Shape: A19
 Bulb Included: Bulb Not Included
 Max. Wattage Per Lamp (W): 12
 Lamp Base: E26
 Input Voltage (V): 120
 Upon Request: 277Vac / GU24

LED

OPTICAL

RATINGS AND CERTIFICATIONS

Certified By: Certified for North American Standards
 IP rating: IP20

PROJECT
TYPE
SPECIFIER
QUANTITY
DATE

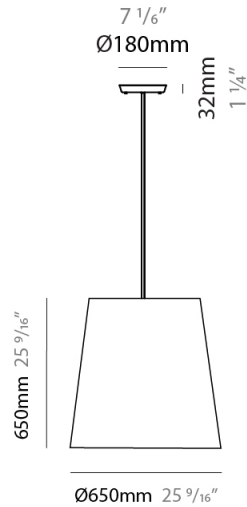

EXCENTRICA SUSPENSION

D51021-

PROJECT

TYPE

SPECIFIER

QUANTITY

DATE

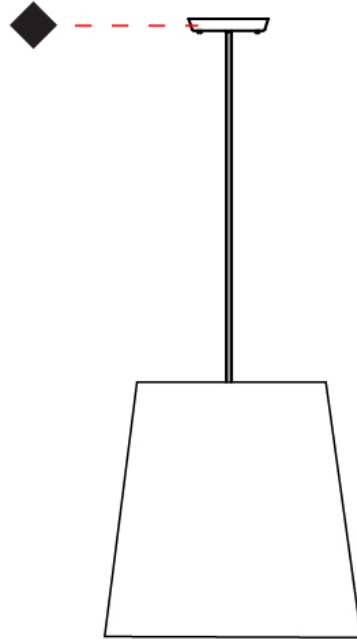

D

PROJECT	_____
TYPE	_____
SPECIFIER	_____
QUANTITY	_____
DATE	_____

EXCENTRICA SURFACE

D53011-

base number Finish
Options

- To build a product code in our configurator select the specify button on the base model # product page
- To build a manual product code on this datasheet choose from the options listed below in blue font and add the suffix to the base model #

GENERAL

Series: Excentrica
 Brand: Fambuena
 Division: Design
 Mounting Type: Surface
 Mounting Location: Wall
 Subcategory: Ambient

PHYSICAL

Shape: Cylinder
 Diameter (mm): 230
 Diameter (in): 9 1/16
 Height (mm): 270
 Height (in): 10 5/8
 Extension (mm): 320
 Extension (in): 12 5/8
 Light Distribution: Direct
 Diffuser: Cotton Shade
 Fixture Finish: WHI / BLK / BRA / PWT
 Fixture Material: Metal

ELECTRICAL

Number of Lamps: 1
 Lamp Type: LED Retrofit
 Lamp Shape: B10
 Bulb Included: Bulb Not Included
 Max. Wattage Per Lamp (W): 4
 Lamp Base: E12
 Input Voltage (V): 120

LED

OPTICAL

RATINGS AND CERTIFICATIONS

Certified By: Certified for North American Standards
 IP rating: IP20

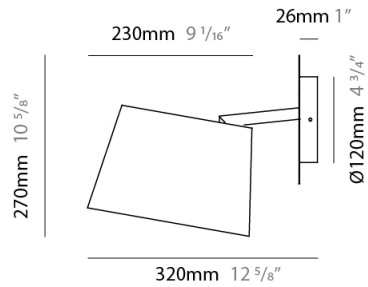

D53011-

PROJECT

TYPE

SPECIFIER

QUANTITY

DATE

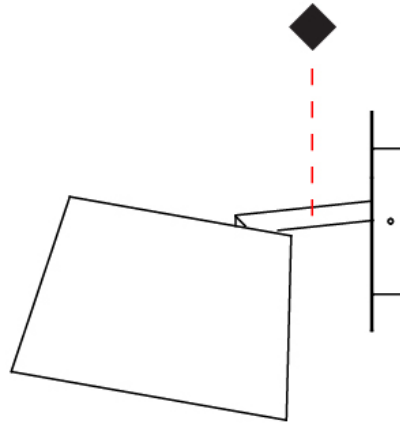

EXCENTRICA PORTABLE

D54006-

base number Finish
Options

PROJECT	_____
TYPE	_____
SPECIFIER	_____
QUANTITY	_____
DATE	_____

- To build a product code in our configurator select the specify button on the base model # product page
- To build a manual product code on this datasheet choose from the options listed below in blue font and add the suffix to the base model #

GENERAL

Series: Excentrica _____
 Brand: Fambuena _____
 Division: Design _____
 Mounting Type: Portable _____
 Mounting Location: Table _____
 Subcategory: Table _____

PHYSICAL

Shape: Cylinder _____
 Diameter (mm): 380 _____
 Diameter (in): 14 ¹⁵/₁₆ _____
 Height (mm): 700 _____
 Height (in): 27 ⁹/₁₆ _____
 Light Distribution: Direct _____
 Diffuser: Cotton Shade _____
 Fixture Finish: WHI / BLK _____
 Fixture Material: Metal _____
 Upon Request: Bolt Down _____

ELECTRICAL

Number of Lamps: 1 _____
 Lamp Type: LED Retrofit _____
 Lamp Shape: A19 _____
 Bulb Included: Bulb Not Included _____
 Max. Wattage Per Lamp (W): 7 _____
 Lamp Base: E26 _____
 Input Voltage (V): 120 _____
 Upon Request: 277Vac / GU24 _____

LED

OPTICAL

RATINGS AND CERTIFICATIONS

Certified By: Certified for North American Standards _____
 IP rating: IP20 _____

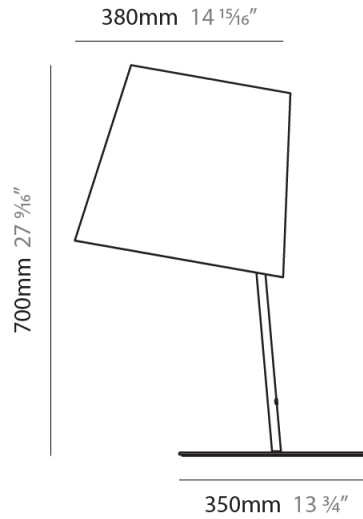

D54006-

PROJECT

TYPE

SPECIFIER

QUANTITY

DATE

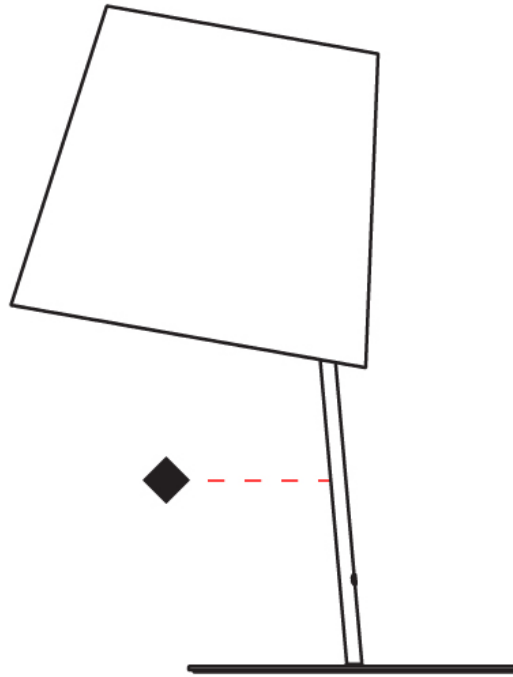

EXCENTRICA PORTABLE

D54007-

base number Finish
Options

- To build a product code in our configurator select the specify button on the base model # product page
- To build a manual product code on this datasheet choose from the options listed below in blue font and add the suffix to the base model #

GENERAL

Series: Excentrica
Brand: Fambuena
Division: Design
Mounting Type: Portable
Mounting Location: Table
Subcategory: Table

PHYSICAL

Shape: Cylinder
Diameter (mm): 230
Diameter (in): 9 1/16
Height (mm): 440
Height (in): 17 5/16
Light Distribution: Direct
Diffuser: Cotton Shade
Fixture Finish: WHI / BLK
Holder Finish: WHI / BLK
Fixture Material: Metal
Upon Request: Bolt Down

ELECTRICAL

Number of Lamps: 1
Lamp Type: LED Retrofit
Lamp Shape: B10
Bulb Included: Bulb Not Included
Max. Wattage Per Lamp (W): 4
Lamp Base: E12
Input Voltage (V): 120

LED

OPTICAL

RATINGS AND CERTIFICATIONS

Certified By: Certified for North American Standards
IP rating: IP20

PROJECT	_____
TYPE	_____
SPECIFIER	_____
QUANTITY	_____
DATE	_____

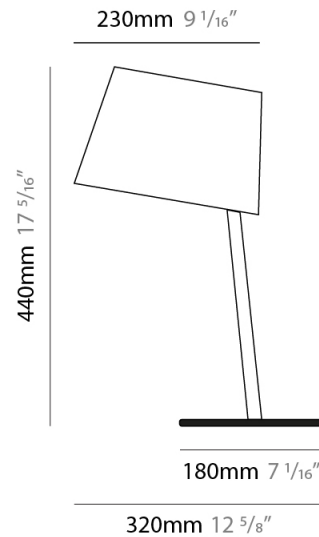

D54007-

PROJECT

TYPE

SPECIFIER

QUANTITY

DATE

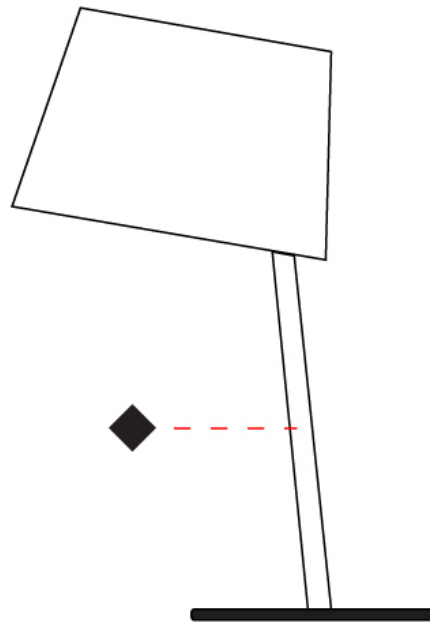

EXCENTRICA PORTABLE

D54008-

base number Finish
Options

PROJECT	_____
TYPE	_____
SPECIFIER	_____
QUANTITY	_____
DATE	_____

- To build a product code in our configurator select the specify button on the base model # product page
- To build a manual product code on this datasheet choose from the options listed below in blue font and add the suffix to the base model #

GENERAL

Series: Excentrica
 Brand: Fambuena
 Division: Design
 Mounting Type: Portable
 Mounting Location: Table
 Subcategory: Table

PHYSICAL

Shape: Cylinder
 Diameter (mm): 230
 Diameter (in): 9 1/16
 Height (mm): 510
 Height (in): 20 1/16
 Extension (mm): 740
 Extension (in): 29 1/8
 Light Distribution: Direct
 Diffuser: Cotton Shade
 Fixture Finish: WHI / BLK
 Holder Finish: WHI / BLK
 Fixture Material: Metal
 Upon Request: Bolt Down

ELECTRICAL

Number of Lamps: 1
 Lamp Type: LED Retrofit
 Lamp Shape: B10
 Bulb Included: Bulb Not Included
 Max. Wattage Per Lamp (W): 4
 Lamp Base: E12
 Input Voltage (V): 120

LED

OPTICAL

RATINGS AND CERTIFICATIONS

Certified By: Certified for North American Standards
 IP rating: IP20

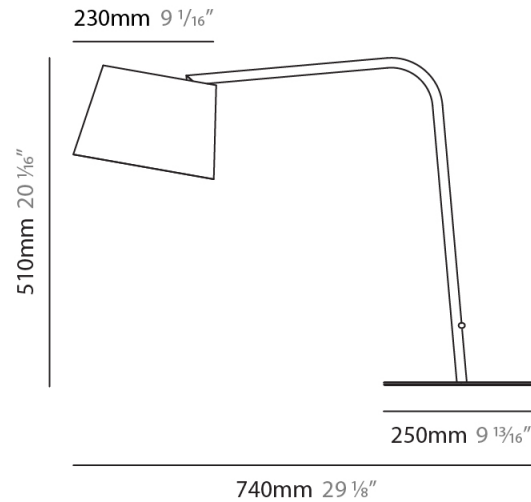

D54008-

PROJECT

TYPE

SPECIFIER

QUANTITY

DATE

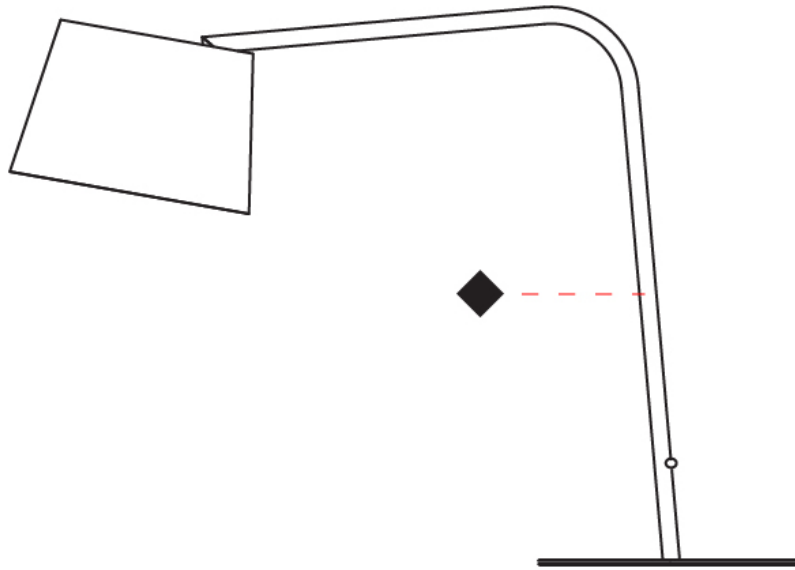

EXCENTRICA PORTABLE

D54046- _____ - _____

base number Finish Options Finish Options

- To build a product code in our configurator select the specify button on the base model # product page
- To build a manual product code on this datasheet choose from the options listed below in blue font and add the suffix to the base model #

GENERAL

Series: Excentrica
 Brand: Fambuena
 Division: Design
 Mounting Type: Portable
 Mounting Location: Table
 Subcategory: Table

PHYSICAL

Shape: Cylinder
 Diameter (mm): 380
 Diameter (in): 14 ¹⁵/₁₆
 Height (mm): 700
 Height (in): 27 ⁹/₁₆
 Light Distribution: Direct
 Diffuser: Cotton Shade
[Fixture Finish: BRA / PWT](#)
 Holder Finish: BLM / WHM
 Fixture Material: Metal / Marble
 Upon Request: Bolt Down

ELECTRICAL

Number of Lamps: 1
 Lamp Type: LED Retrofit
 Lamp Shape: A19
 Bulb Included: Bulb Not Included
 Max. Wattage Per Lamp (W): 7
 Lamp Base: E26
 Input Voltage (V): 120
 Upon Request: 277Vac / GU24

LED

OPTICAL

RATINGS AND CERTIFICATIONS

Certified By: Certified for North American Standards
 IP rating: IP20

PROJECT
TYPE
SPECIFIER
QUANTITY
DATE

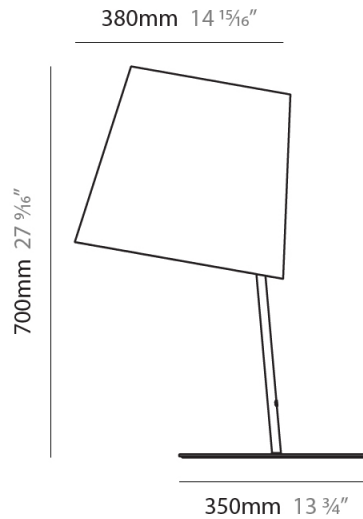

D54046-

PROJECT	_____
TYPE	_____
SPECIFIER	_____
QUANTITY	_____
DATE	_____

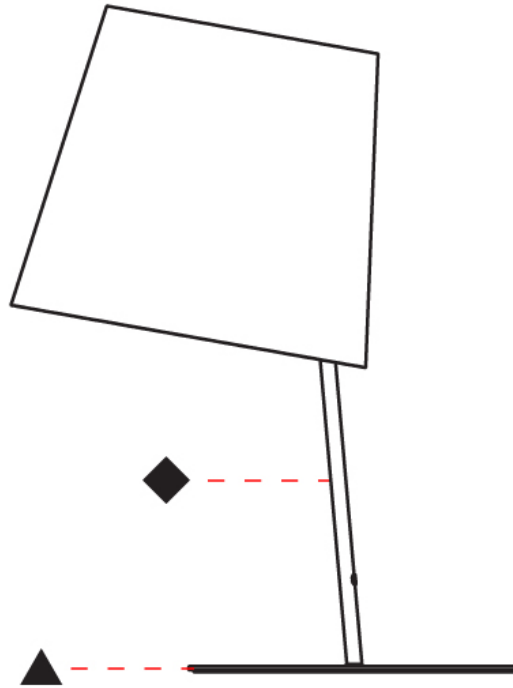

EXCENTRICA PORTABLE

D54047- _____ - _____

base number Finish Options Finish Options

- To build a product code in our configurator select the specify button on the base model # product page
- To build a manual product code on this datasheet choose from the options listed below in blue font and add the suffix to the base model #

GENERAL

Series: Excentrica
 Brand: Fambuena
 Division: Design
 Mounting Type: Portable
 Mounting Location: Table
 Subcategory: Table

PHYSICAL

Shape: Cylinder
 Diameter (mm): 230
 Diameter (in): 9 1/16
 Height (mm): 440
 Height (in): 17 5/16
 Light Distribution: Direct
 Diffuser: Cotton Shade
 Fixture Finish: [BRA / PWT](#)
 Holder Finish: [BLM / WHM](#)
 Fixture Material: [Metal / Marble](#)
 Upon Request: Bolt Down

ELECTRICAL

Number of Lamps: 1
 Lamp Type: LED Retrofit
 Lamp Shape: B10
 Bulb Included: Bulb Not Included
 Max. Wattage Per Lamp (W): 4
 Lamp Base: E12
 Input Voltage (V): 120

LED

OPTICAL

RATINGS AND CERTIFICATIONS

Certified By: Certified for North American Standards
 IP rating: IP20

PROJECT _____
 TYPE _____
 SPECIFIER _____
 QUANTITY _____
 DATE _____

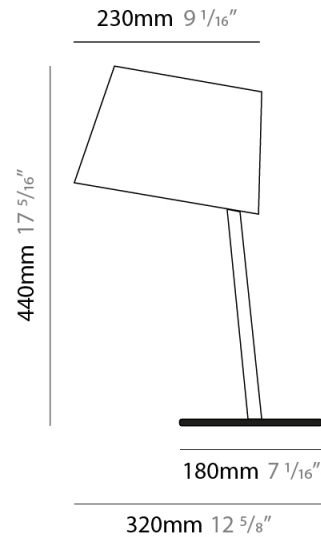

D54047-

PROJECT	_____
TYPE	_____
SPECIFIER	_____
QUANTITY	_____
DATE	_____

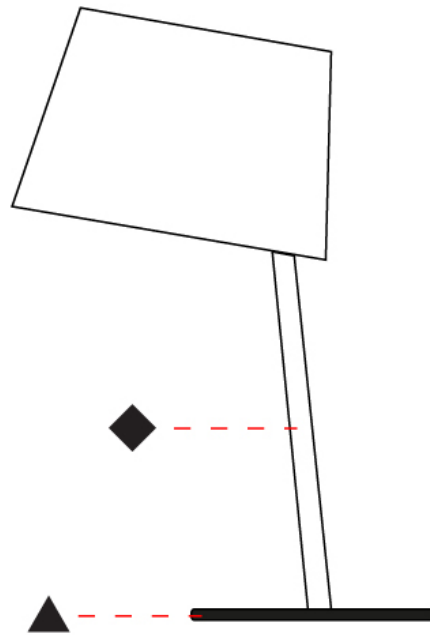

D

EXCENTRICA PORTABLE

D54048- -

base number Finish Options Finish Options

- To build a product code in our configurator select the specify button on the base model # product page
- To build a manual product code on this datasheet choose from the options listed below in blue font and add the suffix to the base model #

GENERAL

Series: Excentrica
 Brand: Fambuena
 Division: Design
 Mounting Type: Portable
 Mounting Location: Table
 Subcategory: Table

PHYSICAL

Shape: Cylinder
 Diameter (mm): 230
 Diameter (in): 9 1/16
 Height (mm): 510
 Height (in): 20 1/16
 Extension (mm): 740
 Extension (in): 29 1/8
 Light Distribution: Direct
 Diffuser: Cotton Shade
 Fixture Finish: BRA / PWT
 Holder Finish: BLM / WHM
 Fixture Material: Metal / Marble
 Upon Request: Bolt Down

ELECTRICAL

Number of Lamps: 1
 Lamp Type: LED Retrofit
 Lamp Shape: B10
 Bulb Included: Bulb Not Included
 Max. Wattage Per Lamp (W): 4
 Lamp Base: E12
 Input Voltage (V): 120

LED

OPTICAL

RATINGS AND CERTIFICATIONS

Certified By: Certified for North American Standards
 IP rating: IP20

PROJECT _____
 TYPE _____
 SPECIFIER _____
 QUANTITY _____
 DATE _____

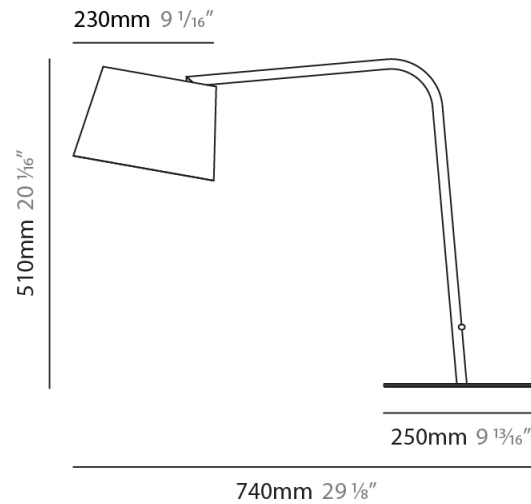

D54048-

PROJECT

TYPE

SPECIFIER

QUANTITY

DATE

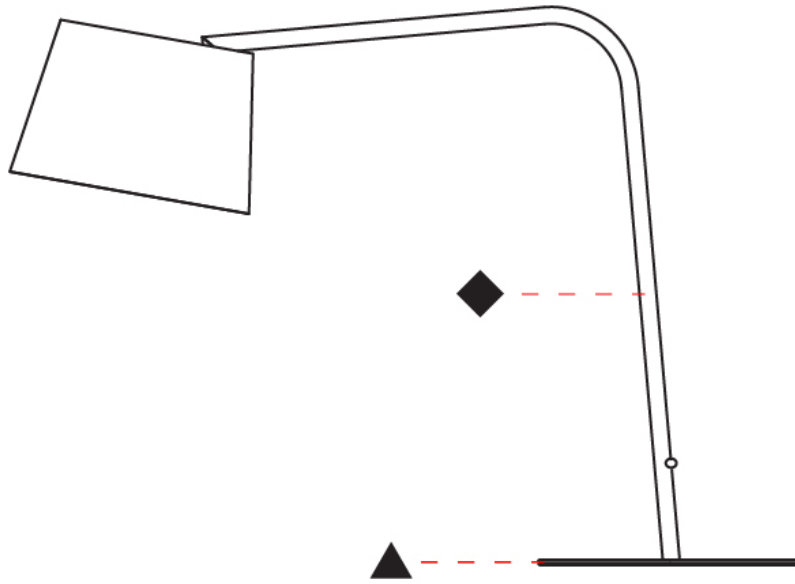

D

EXCENTRICA PORTABLE

D54051- -

base number Finish Options Finish Options

- To build a product code in our configurator select the specify button on the base model # product page
- To build a manual product code on this datasheet choose from the options listed below in blue font and add the suffix to the base model #

GENERAL

Series: Excentrica
Brand: Fambuena
Division: Design
Mounting Type: Portable
Mounting Location: Floor
Subcategory: Floor

PHYSICAL

Shape: Cylinder
Diameter (mm): 230
Diameter (in): 9 1/16
Height (mm): 1350
Height (in): 53 1/8
Light Distribution: Direct
Diffuser: Cotton Shade
Fixture Finish: [BRA](#) / [PWT](#)
Holder Finish: BLM / WHM
Fixture Material: Metal / Marble

ELECTRICAL

Number of Lamps: 1
Lamp Type: LED Retrofit
Lamp Shape: B10
Bulb Included: Bulb Not Included
Max. Wattage Per Lamp (W): 4
Lamp Base: E12
Input Voltage (V): 120

LED

OPTICAL

RATINGS AND CERTIFICATIONS

Certified By: Certified for North American Standards
IP rating: IP20

PROJECT	_____
TYPE	_____
SPECIFIER	_____
QUANTITY	_____
DATE	_____

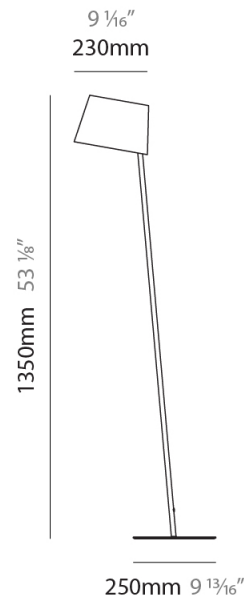

D54051-

PROJECT

TYPE

SPECIFIER

QUANTITY

DATE

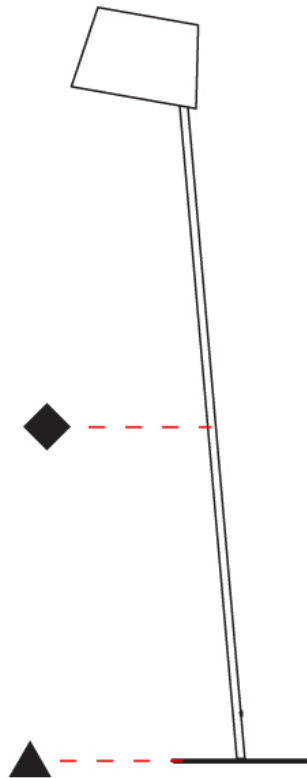

D

PROJECT	_____
TYPE	_____
SPECIFIER	_____
QUANTITY	_____
DATE	_____

Fixture Finish

White - WHI



Black - BLK

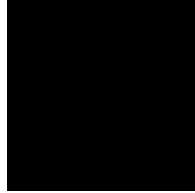

Brass - BRA



Pewter - PWT



Holder Finish

White - WHI



Black - BLK



Black Marble - BLM

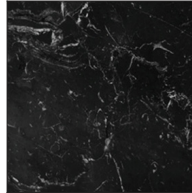

White Marble - WHM



Digital: Not all screens are calibrated the same, and therefore, colors will appear differently between screens.

Physical: When texture is involved, there will be variations in color, character and tone within a product series and between product families.



PROJECT	
TYPE	
SPECIFIER	
QUANTITY	
DATE	

LEGEND

floor-mounted	pivotal	special LED (upon request) RGB, RGBW, tunable, gold+, meat+, art+, fashion+
wall and ceiling: recessed and surface mounted	rotating	warm dim / natural dimming LED
ceiling-mounted and wall-mounted	illuminate tilted	rechargeable battery powered
wall-mounted	color of suspension cable	fixture with natural vivid LED (upon request)
omni-directional light distribution	length of suspension cable	color rendering index
direct light distribution	reflector degree selection	color temperature
direct/indirect light distribution	super spot	lumen (luminous flux)
indirect light distribution	lens	efficacy (lumens per watt)
asymmetric light distribution	lens pack	Unified Glare Rating (UGR) range from 5-40
aura light distribution	shine ring	marine grade (AISI 316 stainless steel)
round wall or ceiling cut-out	integrated shine ring with diffuser	walk on
square wall or ceiling cut-out	free individual colors 01-29	drive on
the supplied jig specifies the cutout dimensions	individual colors: 00 (free of charge), 01-25 (extra charge)	Dark Sky Compliance
minimum distance (meters) lamp - object	luminaire part to be colored (F1)	Americans with Disabilities Act (less than 4" off the wall located between 27"-84" from floor)
recessed depth	luminaire part to be colored (F2)	lamp protected against explosion
ceiling thickness in mm	luminaire part to be colored (F3)	blown glass using traditional methods by master glass blower
ceiling thickness selection	luminaire part to be colored (F4)	acoustic material
dimmable DP (phase), DV (0-10V), DD (dali), DS (step-dim)	luminaire part to be colored (F5)	protection class I, protection insulation
included or excluded LED driver/transformer/control gear	color of 3-circuit adaptor	protection class II, protection insulation
separately switchable	indirect diffuser	ETL Certified to UL and CSA Standards
sensor	direct diffuser	UL Certified to UL and CSA Standards
remote control	ball-proof (upon request)	CSA Certified to UL and CSA Standards
available upon request	accessory	Certified for North American Standards

IP RATING

IP20	protected against ingress of solid bodies greater than 12.5mm (finger)
IP33	protected against ingress of solid bodies greater than 2.5mm protected against sprays of water up to 60 degrees from the vertical (rain)
IP40	protected against ingress of solid bodies greater than 1mm (wire) no protection against the ingress of moisture
IP43	protected against ingress of solid bodies greater than 1mm (wire) protected against sprays of water up to 60 degrees from the vertical (rain)
IP44	protected against ingress of solid bodies greater than 1mm (wire) protected against water splashed from all directions
IP54	protected against limited ingress of dust (wet rooms/covered outdoor areas) protected against water splashed from all directions
IP65	protected against ingress of dust protected against jets of water
IP66	protected against ingress of dust protected against powerful jets of water or heavy seas
IP67	protected against ingress of dust protected against immersion of water between 15cm - 1m for 30 minutes
IP68	protected against ingress of dust protected against immersion of water under pressure for long periods

IK RATING

IK01	protected against 0.14 joules impact (equivalent to 0.25kg mass dropped from 56mm above the surface)
IK02	protected against 0.2 joules impact (equivalent to 0.25kg mass dropped from 80mm above the surface)
IK03	protected against 0.35 joules impact (equivalent to 0.25kg mass dropped from 140mm above the surface)
IK04	protected against 0.5 joules impact (equivalent to 0.25kg mass dropped from 200mm above the surface)
IK05	protected against 0.7 joules impact (equivalent to 0.25kg mass dropped from 280mm above the surface)
IK06	protected against 1 joules impact (equivalent to 0.25kg mass dropped from 400mm above the surface)
IK07	protected against 2 joules impact (equivalent to 0.5kg mass dropped from 400mm above the surface)
IK08	protected against 5 joules impact (equivalent to 1.7kg mass dropped from 300mm above the surface)
IK09	protected against 10 joules impact (equivalent to 5.0kg mass dropped from 200mm above the surface)
IK10	protected against 20 joules impact (equivalent to 5.0kg mass dropped from 400mm above the surface)