

PROJECT	
TYPE	
SPECIFIER	
QUANTITY	
DATE	

## FLAMINGO POST

### E9B153-

base number            Finish             
Options           

- To build a product code in our configurator select the specify button on the base model # product page
- To build a manual product code on this datasheet choose from the options listed below in blue font and add the suffix to the base model #

#### GENERAL

Series: Flamingo  
 Brand: Platek  
 Division: Exterior  
 Mounting Type: Post  
 Mounting Location: Above Ground  
 Subcategory: Bollard - Garden

#### PHYSICAL

Shape: Abstract  
 Diameter (mm): 55  
 Diameter (in): 2 <sup>3</sup>/<sub>16</sub>  
 Height (mm): 800  
 Height (in): 31 <sup>1</sup>/<sub>2</sub>  
 Extension (mm): 450  
 Extension (in): 17 <sup>11</sup>/<sub>16</sub>  
 Light Distribution: Direct  
 Weight (kg): 1.4  
 Weight (lbs): 3  
 Screws: No visible screws  
 Diffuser: Frosted Methacrylate - 2mm  
 Fixture Finish: [BLK / WHI / COR](#)  
 Fixture Material: Aluminum  
 Upon Request: Finishes - Anthracite, Bronze

#### ELECTRICAL

Lamp Type: LED  
 Input Wattage (W): 9  
 Total Output Wattage (W): 7  
 Dimming: Non-Dimmable / 0-10V Dimming  
 Driver Included: No  
 Driver Location: Remote  
 Driver Type: Constant Voltage - Universal  
 Driver Class: Class 2  
 Housing: ENCP5  
 Input Voltage (V): 120 - 277  
 Constant Voltage (V): 24

#### LED

Number of LEDs: 1  
 Color Temperature (°K): 3000  
 Max. Delivered Lumen (lm): 385  
 Nominal Lumen (lm): 705  
 CRI: >80 CRI  
 Lamp Life (hrs): 60000

#### OPTICAL

Optic°: 76  
 Beam Angle: Diffused

#### RATINGS AND CERTIFICATIONS

Certified By: Certified for North American Standards  
 IP rating: IP65  
 IK Rating: IK06  
 Bug Rating: B0 U0 G0  
 Upon Request: Higher Maximum Ambient Temperature



## FLAMINGO POST

E9B153-

PROJECT

TYPE

SPECIFIER

QUANTITY

DATE

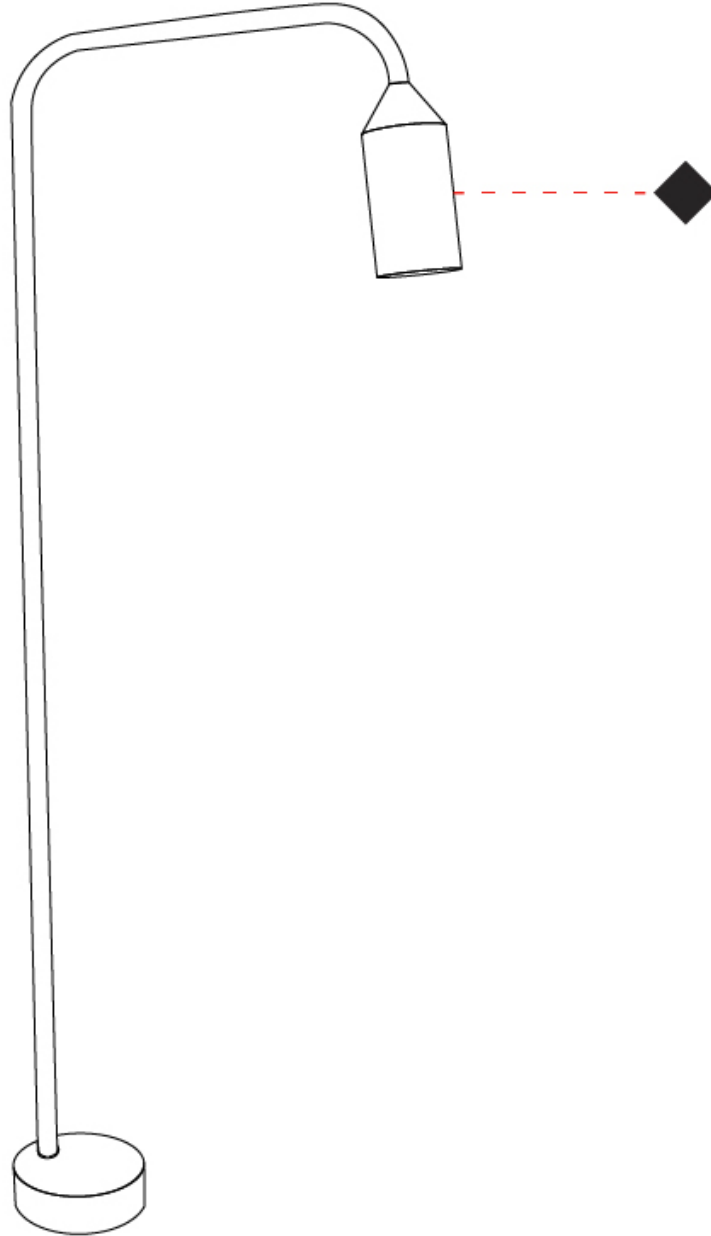

E

PROJECT	
TYPE	
SPECIFIER	
QUANTITY	
DATE	

## FLAMINGO POST

### E9B155-

base number            Finish             
Options           

- To build a product code in our configurator select the specify button on the base model # product page
- To build a manual product code on this datasheet choose from the options listed below in blue font and add the suffix to the base model #

#### GENERAL

Series: Flamingo  
 Brand: Platak  
 Division: Exterior  
 Mounting Type: Post  
 Mounting Location: Above Ground  
 Subcategory: Bollard

#### PHYSICAL

Shape: Abstract  
 Diameter (mm): 55  
 Diameter (in): 2 3/16  
 Height (mm): 1500  
 Height (in): 59 1/16  
 Extension (mm): 450  
 Extension (in): 17 11/16  
 Light Distribution: Direct  
 Weight (kg): 1.8  
 Weight (lbs): 4  
 Screws: No visible screws  
 Diffuser: Frosted Methacrylate - 2mm  
 Fixture Finish: [BLK / WHI / COR](#)  
 Fixture Material: Aluminum  
 Upon Request: Finishes - Anthracite, Bronze

#### ELECTRICAL

Lamp Type: LED  
 Input Wattage (W): 9  
 Total Output Wattage (W): 7  
 Dimming: Non-Dimmable / 0-10V Dimming  
 Driver Included: No  
 Driver Location: Remote  
 Driver Type: Constant Voltage - Universal  
 Driver Class: Class 2  
 Input Voltage (V): 120 - 277  
 Constant Voltage (V): 24

#### LED

Number of LEDs: 1  
 Color Temperature (°K): 3000  
 Max. Delivered Lumen (lm): 385  
 Nominal Lumen (lm): 705  
 CRI: >80 CRI  
 Lamp Life (hrs): 60000

#### OPTICAL

Optic°: 76  
 Beam Angle: Diffused

#### RATINGS AND CERTIFICATIONS

Certified By: Certified for North American Standards  
 IP rating: IP65  
 IK Rating: IK06  
 Bug Rating: B0 U0 G0  
 Upon Request: Higher Maximum Ambient Temperature



## FLAMINGO POST

E9B155-

PROJECT	_____
TYPE	_____
SPECIFIER	_____
QUANTITY	_____
DATE	_____

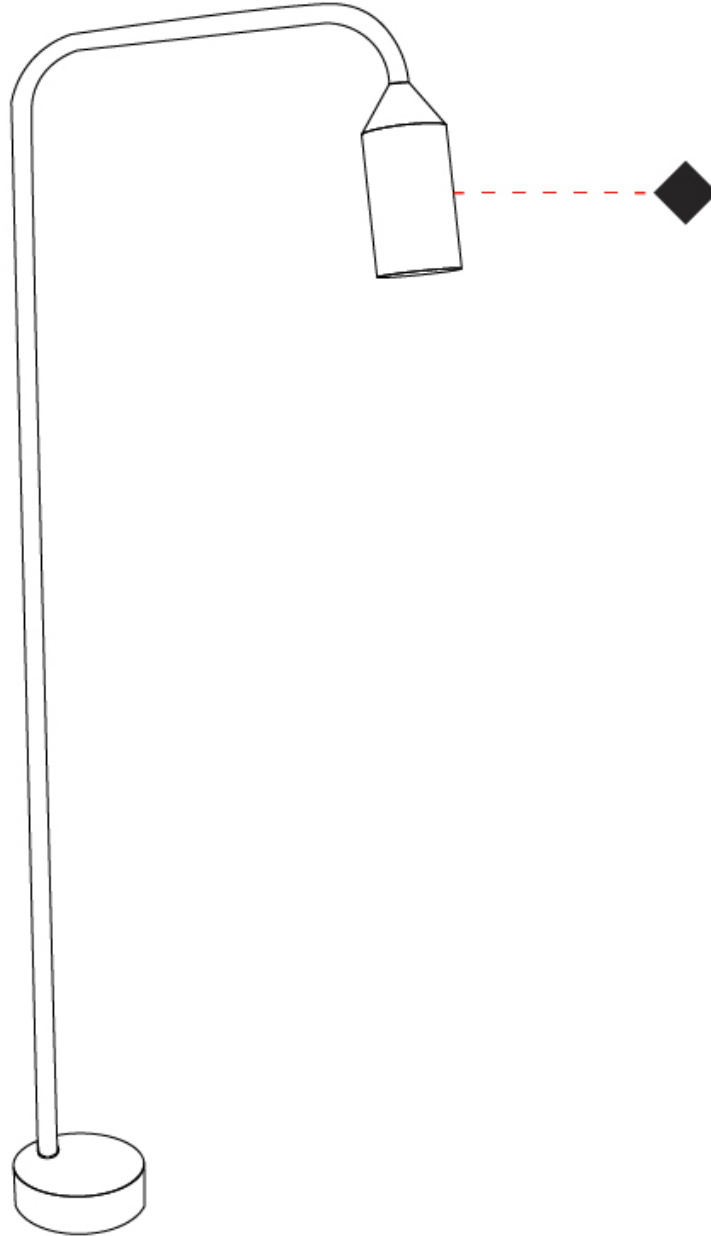

E

PROJECT
TYPE
SPECIFIER
QUANTITY
DATE

## FLAMINGO POST

### E9B157-

base number            Finish             
Options           

- To build a product code in our configurator select the specify button on the base model # product page
- To build a manual product code on this datasheet choose from the options listed below in blue font and add the suffix to the base model #

#### GENERAL

Series: Flamingo  
 Brand: Platek  
 Division: Exterior  
 Mounting Type: Post  
 Mounting Location: Above Ground  
 Subcategory: Bollard

#### PHYSICAL

Shape: Abstract  
 Diameter (mm): 55  
 Diameter (in): 2 3/16  
 Height (mm): 1900  
 Height (in): 74 13/16  
 Extension (mm): 450  
 Extension (in): 17 11/16  
 Light Distribution: Direct  
 Weight (kg): 2  
 Weight (lbs): 4.4  
 Screws: No visible screws  
 Diffuser: Frosted Methacrylate - 2mm  
 Fixture Finish: [BLK / WHI / COR](#)  
 Fixture Material: Aluminum  
 Upon Request: Finishes - Anthracite, Bronze

#### ELECTRICAL

Lamp Type: LED  
 Input Wattage (W): 9  
 Total Output Wattage (W): 7  
 Dimming: Non-Dimmable / 0-10V Dimming  
 Driver Included: No  
 Driver Location: Remote  
 Driver Type: Constant Voltage - Universal  
 Driver Class: Class 2  
 Input Voltage (V): 120 - 277  
 Constant Voltage (V): 24

#### LED

Number of LEDs: 1  
 Color Temperature (°K): 3000  
 Max. Delivered Lumen (lm): 385  
 Nominal Lumen (lm): 705  
 CRI: >80 CRI  
 Lamp Life (hrs): 60000

#### OPTICAL

Optic°: 76  
 Beam Angle: Diffused

#### RATINGS AND CERTIFICATIONS

Certified By: Certified for North American Standards  
 IP rating: IP65  
 IK Rating: IK06  
 Bug Rating: B0 U0 G0  
 Upon Request: Higher Maximum Ambient Temperature



## FLAMINGO POST

E9B157-

PROJECT

TYPE

SPECIFIER

QUANTITY

DATE



E

PROJECT	
TYPE	
SPECIFIER	
QUANTITY	
DATE	

## FLAMINGO SURFACE

### E9C092-

base number            Finish             
Options           

- To build a product code in our configurator select the specify button on the base model # product page
- To build a manual product code on this datasheet choose from the options listed below in blue font and add the suffix to the base model #

#### GENERAL

Series: Flamingo  
 Brand: Platak  
 Division: Exterior  
 Mounting Type: Surface  
 Mounting Location: Ceiling  
 Subcategory: Downlight

#### PHYSICAL

Shape: Abstract  
 Diameter (mm): 55  
 Diameter (in): 2 3/16  
 Height (mm): 170  
 Height (in): 6 11/16  
 Extension (mm): 450  
 Extension (in): 17 11/16  
 Light Distribution: Direct  
 Weight (kg): 0.6  
 Weight (lbs): 1.3  
 Screws: No visible screws  
 Diffuser: Frosted Methacrylate - 2mm  
 Fixture Finish: [BLK / WHI / COR](#)  
 Fixture Material: Aluminum  
 Upon Request: Finishes - Anthracite, Bronze

#### ELECTRICAL

Lamp Type: LED  
 Input Wattage (W): 9  
 Total Output Wattage (W): 7  
 Dimming: Non-Dimmable / 0-10V Dimming  
 Driver Included: No  
 Driver Location: Remote  
 Driver Type: Constant Voltage - Universal  
 Driver Class: Class 2  
 Input Voltage (V): 120 - 277  
 Constant Voltage (V): 24

#### LED

Number of LEDs: 1  
 Color Temperature (°K): 3000  
 Max. Delivered Lumen (lm): 385  
 Nominal Lumen (lm): 705  
 CRI: >80 CRI  
 Lamp Life (hrs): 60000

#### OPTICAL

Optic°: 76  
 Beam Angle: Diffused

#### RATINGS AND CERTIFICATIONS

Certified By: Certified for North American Standards  
 IP rating: IP65  
 IK Rating: IK06  
 Bug Rating: B0 U0 G0  
 Upon Request: Higher Maximum Ambient Temperature



E9C092-

PROJECT

TYPE

SPECIFIER

QUANTITY

DATE



E



PROJECT
TYPE
SPECIFIER
QUANTITY
DATE

## FLAMINGO SURFACE

### E9W500-

base number                      Finish                       
Options

- To build a product code in our configurator select the specify button on the base model # product page
- To build a manual product code on this datasheet choose from the options listed below in blue font and add the suffix to the base model #

#### GENERAL

Series: Flamingo  
 Brand: Platek  
 Division: Exterior  
 Mounting Type: Surface  
 Mounting Location: Wall  
 Subcategory: Downlight

#### PHYSICAL

Shape: Abstract  
 Diameter (mm): 55  
 Diameter (in): 2 3/16  
 Height (mm): 800  
 Height (in): 31 1/2  
 Extension (mm): 370  
 Extension (in): 14 9/16  
 Light Distribution: Direct  
 Weight (kg): 1  
 Weight (lbs): 2.2  
 Screws: No visible screws  
 Diffuser: Frosted Methacrylate - 2mm  
 Fixture Finish: [BLK / WHI / COR](#)  
 Fixture Material: Aluminum  
 Upon Request: Finishes - Anthracite, Bronze

#### ELECTRICAL

Lamp Type: LED  
 Input Wattage (W): 9  
 Total Output Wattage (W): 7.5  
 Dimming: Non-Dimmable / 0-10V Dimming  
 Driver Included: No  
 Driver Location: Remote  
 Driver Type: Constant Voltage - Universal  
 Driver Class: Class 2  
 Input Voltage (V): 120 - 277  
 Constant Voltage (V): 24

#### LED

Number of LEDs: 1  
 Color Temperature (°K): 3000  
 Max. Delivered Lumen (lm): 385  
 Nominal Lumen (lm): 705  
 CRI: >80 CRI  
 Lamp Life (hrs): 60000

#### OPTICAL

Optic°: 76  
 Beam Angle: Diffused

#### RATINGS AND CERTIFICATIONS

Certified By: Certified for North American Standards  
 IP rating: IP65  
 IK Rating: IK06  
 Bug Rating: B0 U0 G0  
 Upon Request: Higher Maximum Ambient Temperature

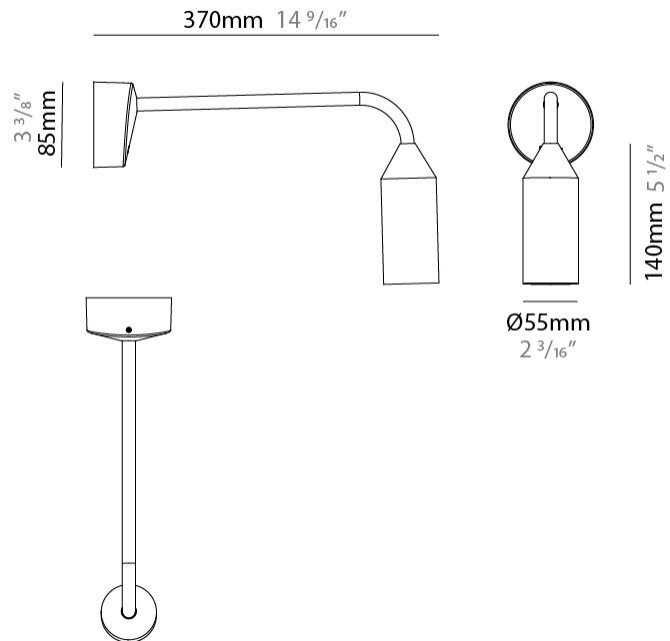

E9W500-

PROJECT	_____
TYPE	_____
SPECIFIER	_____
QUANTITY	_____
DATE	_____

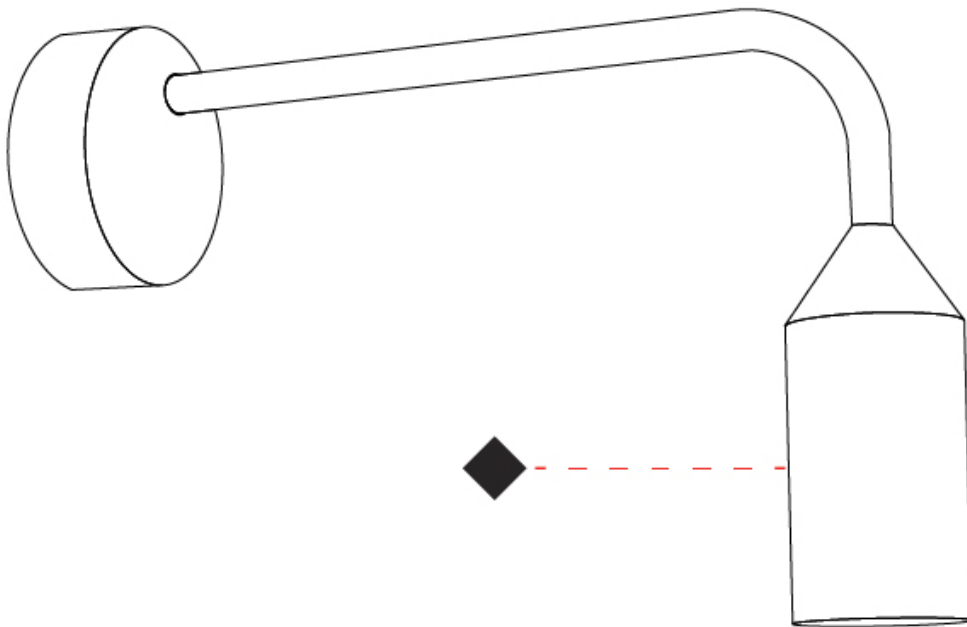

## FLAMINGO SURFACE

### E9W502-

base number            Finish             
Options           

- To build a product code in our configurator select the specify button on the base model # product page
- To build a manual product code on this datasheet choose from the options listed below in blue font and add the suffix to the base model #

#### GENERAL

Series: Flamingo  
Brand: Platek  
Division: Exterior  
Mounting Type: Surface  
Mounting Location: Wall  
Subcategory: Downlight

#### PHYSICAL

Shape: Abstract  
Diameter (mm): 55  
Diameter (in): 2 3/16  
Height (mm): 850  
Height (in): 33 7/16  
Extension (mm): 1400  
Extension (in): 55 1/8  
Light Distribution: Direct  
Weight (kg): 5  
Weight (lbs): 11  
Installation Requirement: Waterproof J-Box is included  
Screws: No visible screws  
Diffuser: Frosted Methacrylate - 2mm  
Fixture Finish: [BLK](#) / [WHI](#) / [COR](#)  
Fixture Material: Aluminum  
Upon Request: Finishes - Anthracite, Bronze

#### ELECTRICAL

Lamp Type: LED  
Input Wattage (W): 9  
Total Output Wattage (W): 1.5  
Dimming: Non-Dimmable / 0-10V Dimming  
Driver Included: No  
Driver Location: Remote  
Driver Type: Constant Voltage - Universal  
Driver Class: Class 2  
Housing: ENCP5  
Input Voltage (V): 120 - 277  
Constant Voltage (V): 24

#### LED

Number of LEDs: 1  
Color Temperature (°K): 3000  
Max. Delivered Lumen (lm): 385  
Nominal Lumen (lm): 705  
CRI: >80 CRI  
Lamp Life (hrs): 60000

#### OPTICAL

Optic°: 76  
Beam Angle: Diffused

#### RATINGS AND CERTIFICATIONS

Certified By: Certified for North American Standards  
IP rating: IP65  
IK Rating: IK06  
Bug Rating: B0 U0 G0  
Upon Request: Higher Maximum Ambient Temperature

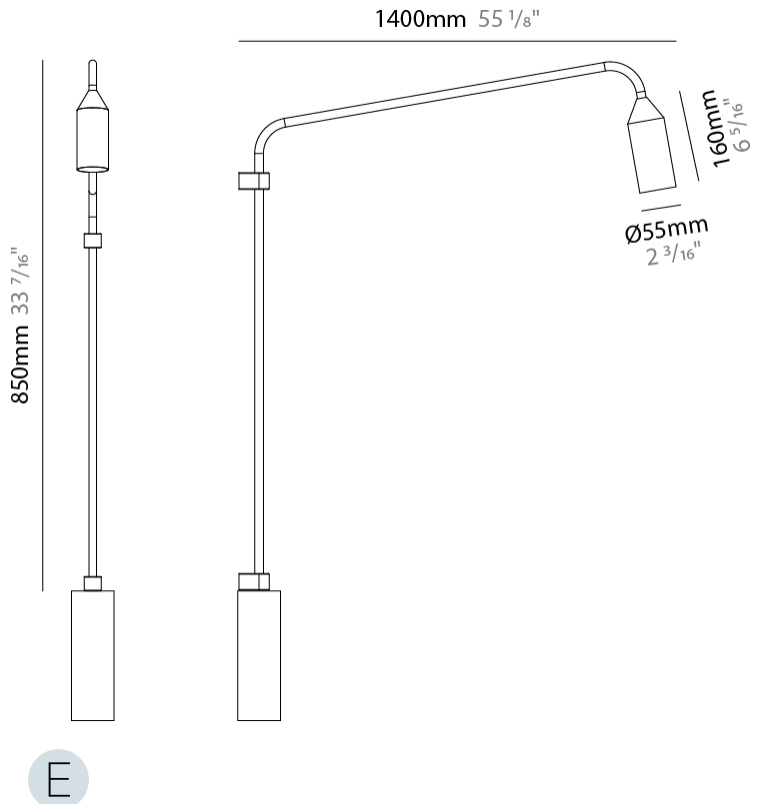

E9W502-

PROJECT

TYPE

SPECIFIER

QUANTITY

DATE

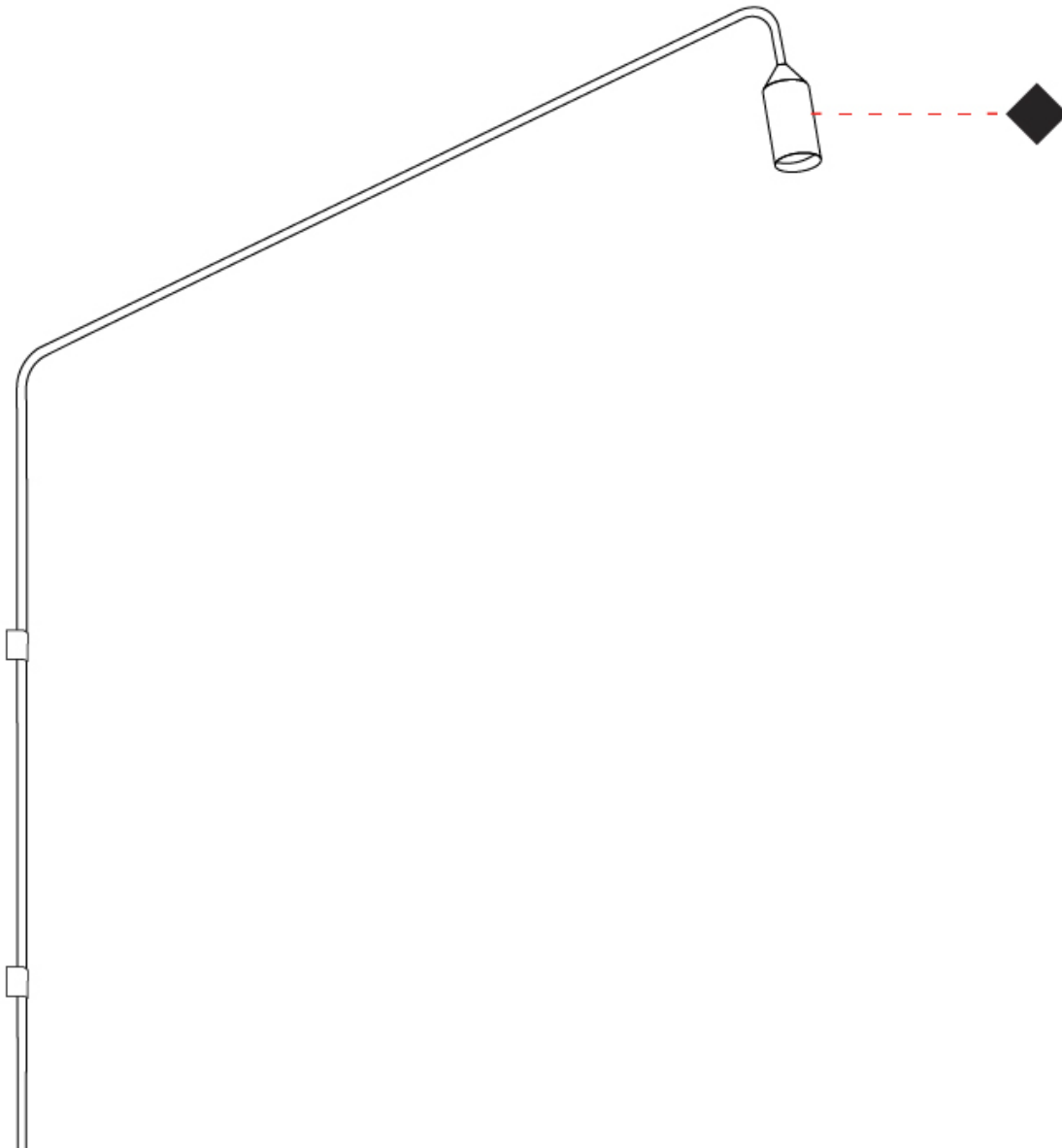

E

PROJECT	_____
TYPE	_____
SPECIFIER	_____
QUANTITY	_____
DATE	_____

## FLAMINGO SURFACE

### E9W504-

base number                      Finish                       
Options                     

- To build a product code in our configurator select the specify button on the base model # product page
- To build a manual product code on this datasheet choose from the options listed below in blue font and add the suffix to the base model #

#### GENERAL

Series: Flamingo  
 Brand: Platek  
 Division: Exterior  
 Mounting Type: Surface  
 Mounting Location: Wall  
 Subcategory: Downlight

#### PHYSICAL

Shape: Abstract  
 Diameter (mm): 55  
 Diameter (in): 2 <sup>3</sup>/<sub>16</sub>  
 Height (mm): 2200  
 Height (in): 86 <sup>5</sup>/<sub>8</sub>  
 Extension (mm): 1400  
 Extension (in): 55 <sup>1</sup>/<sub>8</sub>  
 Light Distribution: Direct  
 Weight (kg): 5.8  
 Weight (lbs): 12.8  
 Installation Requirement: Waterproof J-Box is included  
 Screws: No visible screws  
 Diffuser: Frosted Methacrylate - 2mm  
 Fixture Finish: [BLK](#) / [WHI](#) / [COR](#)  
 Fixture Material: Aluminum  
 Upon Request: Finishes - Anthracite, Bronze

#### ELECTRICAL

Lamp Type: LED  
 Input Wattage (W): 9  
 Total Output Wattage (W): 7.5  
 Dimming: Non-Dimmable / 0-10V Dimming  
 Driver Included: No  
 Driver Location: Remote  
 Driver Type: Constant Voltage - Universal  
 Driver Class: Class 2  
 Input Voltage (V): 120 - 277  
 Constant Voltage (V): 24

#### LED

Number of LEDs: 1  
 Color Temperature (°K): 3000  
 Max. Delivered Lumen (lm): 385  
 Nominal Lumen (lm): 705  
 CRI: >80 CRI  
 Lamp Life (hrs): 60000

#### OPTICAL

Optic°: 76  
 Beam Angle: Diffused

#### RATINGS AND CERTIFICATIONS

Certified By: Certified for North American Standards  
 IP rating: IP65  
 IK Rating: IK06  
 Bug Rating: B0 U0 G0  
 Upon Request: Higher Maximum Ambient Temperature



E9W504-

PROJECT

TYPE

SPECIFIER

QUANTITY

DATE



E

## FLAMINGO COLOR FINISH CHART

PROJECT \_\_\_\_\_

TYPE \_\_\_\_\_

SPECIFIER \_\_\_\_\_

QUANTITY \_\_\_\_\_

DATE \_\_\_\_\_

### Fixture Finish

Black - BLK



White - WHI

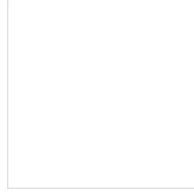

Corten - COR



**Digital:** Not all screens are calibrated the same, and therefore, colors will appear differently between screens.

**Physical:** When texture is involved, there will be variations in color, character and tone within a product series and between product families.



PROJECT	
TYPE	
SPECIFIER	
QUANTITY	
DATE	

### LEGEND

floor-mounted	pivotal	special LED (upon request) RGB, RGBW, tunable, gold+, meat+, art+, fashion+
wall and ceiling: recessed and surface mounted	rotating	warm dim / natural dimming LED
ceiling-mounted and wall-mounted	illuminate tilted	rechargeable battery powered
wall-mounted	color of suspension cable	fixture with natural vivid LED (upon request)
omni-directional light distribution	length of suspension cable	color rendering index
direct light distribution	reflector degree selection	color temperature
direct/indirect light distribution	super spot	lumen (luminous flux)
indirect light distribution	lens	efficacy (lumens per watt)
asymmetric light distribution	lens pack	Unified Glare Rating (UGR) range from 5-40
aura light distribution	shine ring	marine grade (AISI 316 stainless steel)
round wall or ceiling cut-out	integrated shine ring with diffuser	walk on
square wall or ceiling cut-out	free individual colors 01-29	drive on
the supplied jig specifies the cutout dimensions	individual colors: 00 (free of charge), 01-25 (extra charge)	Dark Sky Compliance
minimum distance (meters) lamp - object	luminaire part to be colored (F1)	Americans with Disabilities Act (less than 4" off the wall located between 27"-84" from floor)
recessed depth	luminaire part to be colored (F2)	lamp protected against explosion
ceiling thickness in mm	luminaire part to be colored (F3)	blown glass using traditional methods by master glass blower
ceiling thickness selection	luminaire part to be colored (F4)	acoustic material
dimmable DP (phase), DV (0-10V), DD (dali), DS (step-dim)	luminaire part to be colored (F5)	protection class I, protection insulation
included or excluded LED driver/transformer/control gear	color of 3-circuit adaptor	protection class II, protection insulation
separately switchable	indirect diffuser	ETL Certified to UL and CSA Standards
sensor	direct diffuser	UL Certified to UL and CSA Standards
remote control	ball-proof (upon request)	CSA Certified to UL and CSA Standards
available upon request	accessory	Certified for North American Standards

### IP RATING

IP20	protected against ingress of solid bodies greater than 12.5mm (finger)
IP33	protected against ingress of solid bodies greater than 2.5mm protected against sprays of water up to 60 degrees from the vertical (rain)
IP40	protected against ingress of solid bodies greater than 1mm (wire) no protection against the ingress of moisture
IP43	protected against ingress of solid bodies greater than 1mm (wire) protected against sprays of water up to 60 degrees from the vertical (rain)
IP44	protected against ingress of solid bodies greater than 1mm (wire) protected against water splashed from all directions
IP54	protected against limited ingress of dust (wet rooms/covered outdoor areas) protected against water splashed from all directions
IP65	protected against ingress of dust protected against jets of water
IP66	protected against ingress of dust protected against powerful jets of water or heavy seas
IP67	protected against ingress of dust protected against immersion of water between 15cm - 1m for 30 minutes
IP68	protected against ingress of dust protected against immersion of water under pressure for long periods

### IK RATING

IK01	protected against 0.14 joules impact (equivalent to 0.25kg mass dropped from 56mm above the surface)
IK02	protected against 0.2 joules impact (equivalent to 0.25kg mass dropped from 80mm above the surface)
IK03	protected against 0.35 joules impact (equivalent to 0.25kg mass dropped from 140mm above the surface)
IK04	protected against 0.5 joules impact (equivalent to 0.25kg mass dropped from 200mm above the surface)
IK05	protected against 0.7 joules impact (equivalent to 0.25kg mass dropped from 280mm above the surface)
IK06	protected against 1 joules impact (equivalent to 0.25kg mass dropped from 400mm above the surface)
IK07	protected against 2 joules impact (equivalent to 0.5kg mass dropped from 400mm above the surface)
IK08	protected against 5 joules impact (equivalent to 1.7kg mass dropped from 300mm above the surface)
IK09	protected against 10 joules impact (equivalent to 5.0kg mass dropped from 200mm above the surface)
IK10	protected against 20 joules impact (equivalent to 5.0kg mass dropped from 400mm above the surface)