

PROJECT	_____
TYPE	_____
SPECIFIER	_____
QUANTITY	_____
DATE	_____

## FOLIO SUSPENSION

### D61014-

base number          Finish           
Options         

- To build a product code in our configurator select the specify button on the base model # product page
- To build a manual product code on this datasheet choose from the options listed below in blue font and add the suffix to the base model #

#### GENERAL

Series: Folio \_\_\_\_\_  
 Brand: Linea Zero \_\_\_\_\_  
 Division: Design \_\_\_\_\_  
 Mounting Type: Suspension \_\_\_\_\_  
 Mounting Location: Ceiling \_\_\_\_\_  
 Subcategory: Ambient \_\_\_\_\_

#### PHYSICAL

Shape: Cylinder \_\_\_\_\_  
 Diameter (mm): 600 \_\_\_\_\_  
 Diameter (in): 23 5/8 \_\_\_\_\_  
 Height (mm): 320 \_\_\_\_\_  
 Height (in): 12 5/8 \_\_\_\_\_  
 Max. Overall Height (mm): 1820 \_\_\_\_\_  
 Max. Overall Height (in): 71 5/8 \_\_\_\_\_  
 Light Distribution: Direct / Indirect \_\_\_\_\_  
 Diffuser: Polilux™ Shade - See Finish Options \_\_\_\_\_  
 Fixture Finish: WHI / BLK / SIL / NGD / COP / PKM \_\_\_\_\_  
 Fixture Material: Polilux™/ Metal holder \_\_\_\_\_

#### ELECTRICAL

Number of Lamps: 5 \_\_\_\_\_  
 Lamp Type: LED Retrofit \_\_\_\_\_  
 Bulb Included: Bulb Not Included \_\_\_\_\_  
 Max. Wattage Per Lamp (W): 6 \_\_\_\_\_  
 Lamp Base: E26 \_\_\_\_\_  
 Input Voltage (V): 120 \_\_\_\_\_  
 Upon Request: 277Vac / GU24 \_\_\_\_\_

#### LED

#### OPTICAL

#### RATINGS AND CERTIFICATIONS

Certified By: Certified for North American Standards \_\_\_\_\_  
 IP rating: IP20 \_\_\_\_\_

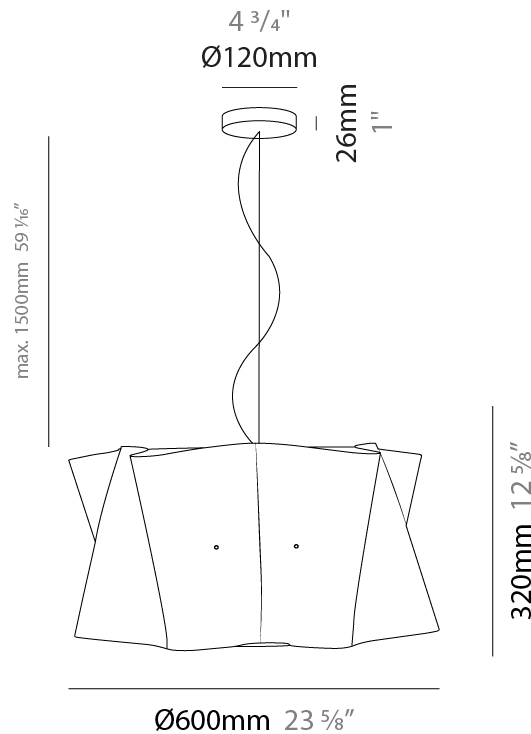

## FOLIO SUSPENSION

D61014-

PROJECT \_\_\_\_\_

TYPE \_\_\_\_\_

SPECIFIER \_\_\_\_\_

QUANTITY \_\_\_\_\_

DATE \_\_\_\_\_

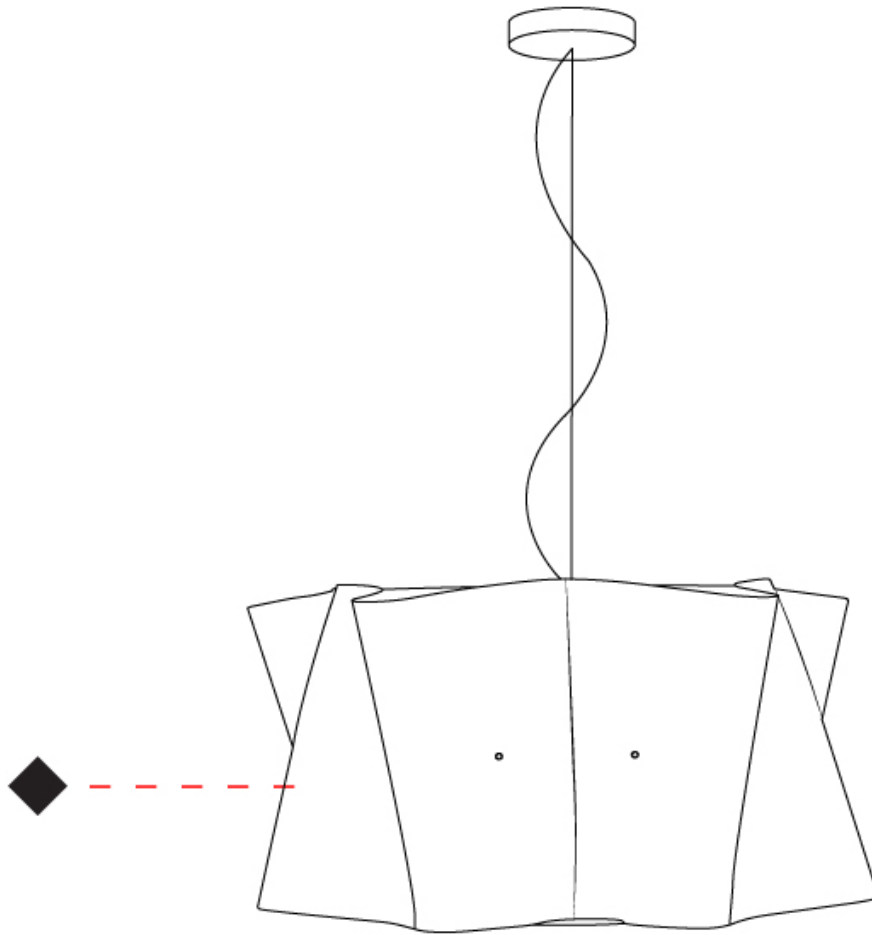

D

PROJECT	_____
TYPE	_____
SPECIFIER	_____
QUANTITY	_____
DATE	_____

## FOLIO SURFACE

### D62011-

base number            Finish             
Options           

- To build a product code in our configurator select the specify button on the base model # product page
- To build a manual product code on this datasheet choose from the options listed below in blue font and add the suffix to the base model #

#### GENERAL

Series: Folio             
 Brand: Linea Zero             
 Division: Design             
 Mounting Type: Surface             
 Mounting Location: Ceiling             
 Subcategory: Ambient           

#### PHYSICAL

Shape: Cylinder             
 Diameter (mm): 600             
 Diameter (in): 23 5/8             
 Height (mm): 320             
 Height (in): 12 5/8             
 Light Distribution: Downlight             
 Diffuser: Polilux™ Shade - See Finish Options             
[Fixture Finish: WHI / PNK / ORG / VIO / SIL / NGD / COP / PKM](#)             
 Fixture Material: Polilux™/ Metal holder           

#### ELECTRICAL

Number of Lamps: 5             
 Lamp Type: LED Retrofit             
 Bulb Included: Bulb Not Included             
 Max. Wattage Per Lamp (W): 6             
 Lamp Base: E26             
 Input Voltage (V): 120             
 Upon Request: 277Vac / GU24           

#### LED

#### OPTICAL

#### RATINGS AND CERTIFICATIONS

Certified By: Certified for North American Standards             
 IP rating: IP20           

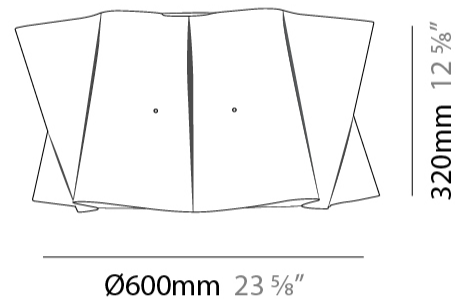

D62011-

PROJECT

TYPE

SPECIFIER

QUANTITY

DATE

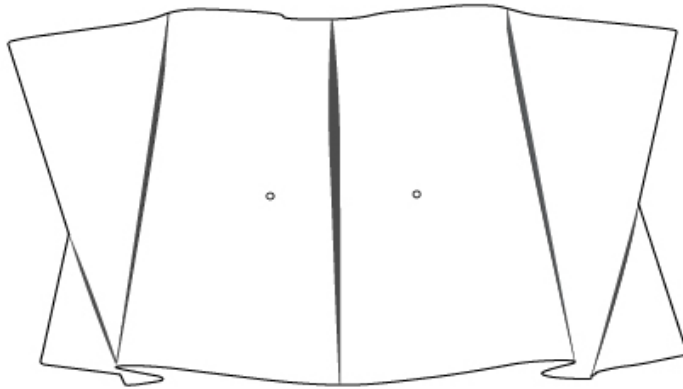

PROJECT	
TYPE	
SPECIFIER	
QUANTITY	
DATE	

## FOLIO SURFACE

### D62012-

base number

- To build a product code in our configurator select the specify button on the base model # product page
- To build a manual product code on this datasheet choose from the options listed below in blue font and add the suffix to the base model #

#### GENERAL

Series: Folio  
 Brand: Linea Zero  
 Division: Design  
 Mounting Type: Surface  
 Mounting Location: Ceiling  
 Subcategory: Ambient

#### PHYSICAL

Shape: Cylinder  
 Diameter (mm): 600  
 Diameter (in): 23 5/8  
 Height (mm): 320  
 Height (in): 12 5/8  
 Light Distribution: Downlight  
 Diffuser: Polilux™ Shade - See Finish Options  
 Fixture Finish: WHI / PNK / ORG / VIO / SIL / NGD / COP / PKM  
 Fixture Material: Polilux™/ Metal holder

#### ELECTRICAL

Number of Lamps: 3  
 Lamp Type: LED Retrofit  
 Bulb Included: Bulb Not Included  
 Max. Wattage Per Lamp (W): 7  
 Lamp Base: E26  
 Input Voltage (V): 120  
 Upon Request: 277Vac / GU24

#### LED

#### OPTICAL

#### RATINGS AND CERTIFICATIONS

Certified By: Certified for North American Standards  
 IP rating: IP20

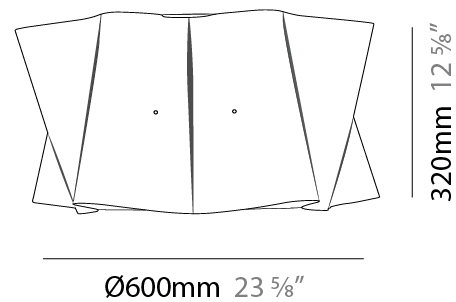

D62012-

PROJECT

TYPE

SPECIFIER

QUANTITY

DATE

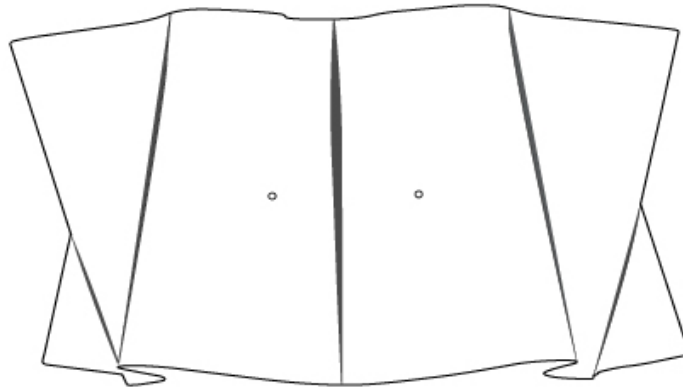

PROJECT
TYPE
SPECIFIER
QUANTITY
DATE

## FOLIO SURFACE

### D62013-

base number            Finish             
Options           

- To build a product code in our configurator select the specify button on the base model # product page
- To build a manual product code on this datasheet choose from the options listed below in blue font and add the suffix to the base model #

#### GENERAL

Series: Folio             
 Brand: Linea Zero             
 Division: Design             
 Mounting Type: Surface             
 Mounting Location: Ceiling             
 Subcategory: Ambient           

#### PHYSICAL

Shape: Cylinder             
 Diameter (mm): 600             
 Diameter (in): 23 5/8             
 Height (mm): 320             
 Height (in): 12 5/8             
 Light Distribution: Downlight             
 Diffuser: Polilux™ Shade - See Finish Options             
[Fixture Finish: WHI / PNK / ORG / VIO / SIL / NGD / COP / PKM](#)             
 Fixture Material: Polilux™/ Metal holder           

#### ELECTRICAL

Number of Lamps: 1             
 Lamp Type: LED Retrofit             
 Bulb Included: Bulb Not Included             
 Max. Wattage Per Lamp (W): 7             
 Lamp Base: E26             
 Input Voltage (V): 120             
 Upon Request: 277Vac / GU24           

#### LED

#### OPTICAL

#### RATINGS AND CERTIFICATIONS

Certified By: Certified for North American Standards             
 IP rating: IP20           

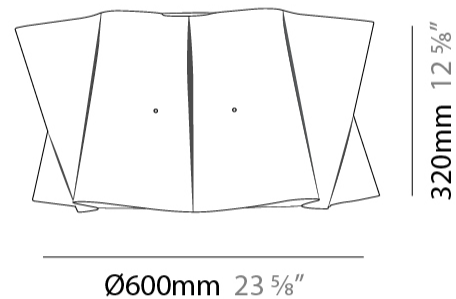

D62013-

PROJECT \_\_\_\_\_

TYPE \_\_\_\_\_

SPECIFIER \_\_\_\_\_

QUANTITY \_\_\_\_\_

DATE \_\_\_\_\_

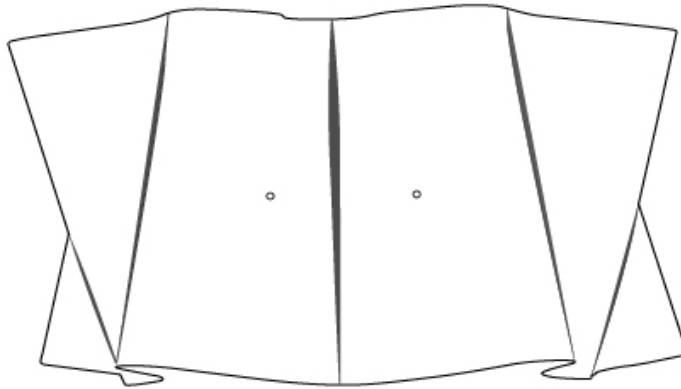



PROJECT
TYPE
SPECIFIER
QUANTITY
DATE

## FOLIO SURFACE

### D62014-

base number            Finish             
Options           

- To build a product code in our configurator select the specify button on the base model # product page
- To build a manual product code on this datasheet choose from the options listed below in blue font and add the suffix to the base model #

#### GENERAL

Series: Folio             
 Brand: Linea Zero             
 Division: Design             
 Mounting Type: Surface             
 Mounting Location: Ceiling             
 Subcategory: Ambient           

#### PHYSICAL

Shape: Cylinder             
 Diameter (mm): 500             
 Diameter (in): 19 11/16             
 Height (mm): 270             
 Height (in): 10 5/8             
 Light Distribution: Downlight             
 Diffuser: Polilux™ Shade - See Finish Options             
 Fixture Finish: WHI / PNK / ORG / VIO / SIL / NGD / COP / PKM             
 Fixture Material: Polilux™/ Metal holder           

#### ELECTRICAL

Number of Lamps: 1             
 Lamp Type: LED Retrofit             
 Bulb Included: Bulb Not Included             
 Max. Wattage Per Lamp (W): 7             
 Lamp Base: E26             
 Input Voltage (V): 120             
 Upon Request: 277Vac / GU24           

#### LED

#### OPTICAL

#### RATINGS AND CERTIFICATIONS

Certified By: Certified for North American Standards             
 IP rating: IP20           

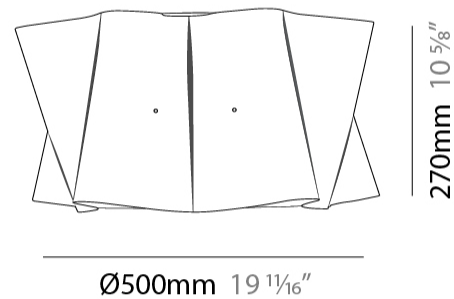

D62014-

PROJECT

TYPE

SPECIFIER

QUANTITY

DATE

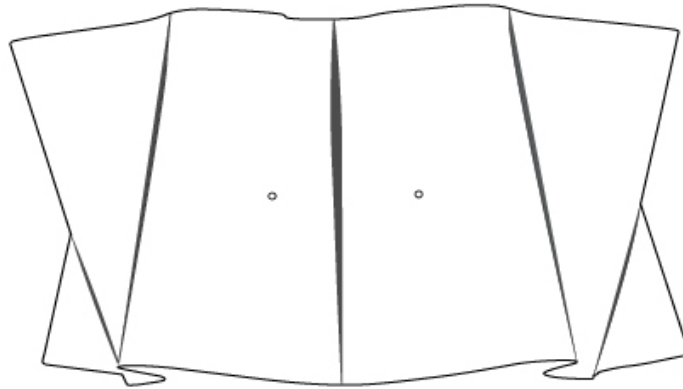

PROJECT
TYPE
SPECIFIER
QUANTITY
DATE

## FOLIO PORTABLE

### D64008-

base number            Finish             
Options           

- To build a product code in our configurator select the specify button on the base model # product page
- To build a manual product code on this datasheet choose from the options listed below in blue font and add the suffix to the base model #

#### GENERAL

Series: Folio             
 Brand: Linea Zero             
 Division: Design             
 Mounting Type: Portable             
 Mounting Location: Table             
 Subcategory: Ambient           

#### PHYSICAL

Shape: Cylinder             
 Diameter (mm): 250             
 Diameter (in): 9 <sup>13</sup>/<sub>16</sub>             
 Height (mm): 370             
 Height (in): 14 <sup>9</sup>/<sub>16</sub>             
 Light Distribution: Omnidirectional             
 Diffuser: Polilux™ Shade - See Finish Options             
 Fixture Finish: WHI / PNK / ORG / VIO / SIL / NGD / COP / PKM             
 Fixture Material: Polilux™/ Metal holder             
 Upon Request: Bolt Down           

#### ELECTRICAL

Number of Lamps: 1             
 Lamp Type: LED Retrofit             
 Bulb Included: Bulb Not Included             
 Max. Wattage Per Lamp (W): 7             
 Lamp Base: E26             
 Input Voltage (V): 120             
 Upon Request: 277Vac / GU24           

#### LED

#### OPTICAL

#### RATINGS AND CERTIFICATIONS

Certified By: Certified for North American Standards             
 IP rating: IP20           



Ø250mm 9 <sup>13</sup>/<sub>16</sub>"

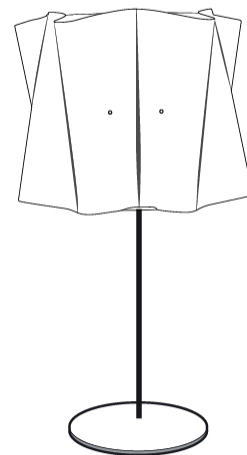

370mm 14 <sup>9</sup>/<sub>16</sub>"



## FOLIO PORTABLE

D64008-

PROJECT

TYPE

SPECIFIER

QUANTITY

DATE

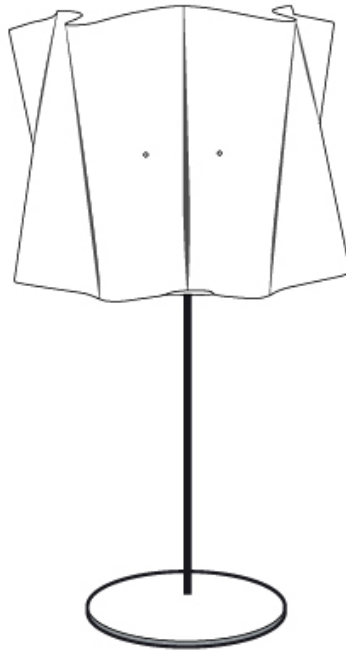

PROJECT
TYPE
SPECIFIER
QUANTITY
DATE

## FOLIO PORTABLE

### D64009-

base number            Finish             
Options           

- To build a product code in our configurator select the specify button on the base model # product page
- To build a manual product code on this datasheet choose from the options listed below in blue font and add the suffix to the base model #

#### GENERAL

Series: Folio             
 Brand: Linea Zero             
 Division: Design             
 Mounting Type: Portable             
 Mounting Location: Table             
 Subcategory: Ambient           

#### PHYSICAL

Shape: Cylinder             
 Diameter (mm): 400             
 Diameter (in): 15 3/4             
 Height (mm): 650             
 Height (in): 25 9/16             
 Light Distribution: Omnidirectional             
 Diffuser: Polilux™ Shade - See Finish Options             
 Fixture Finish: WHI / PNK / ORG / VIO / SIL / NGD / COP / PKM             
 Fixture Material: Polilux™/ Metal holder           

#### ELECTRICAL

Number of Lamps: 1             
 Lamp Type: LED Retrofit             
 Bulb Included: Bulb Not Included             
 Max. Wattage Per Lamp (W): 7             
 Lamp Base: E26             
 Input Voltage (V): 120             
 Lamp Voltage (V): 120             
 Upon Request: 277Vac / GU24           

#### LED

#### OPTICAL

#### RATINGS AND CERTIFICATIONS

Certified By: Certified for North American Standards             
 IP rating: IP20           

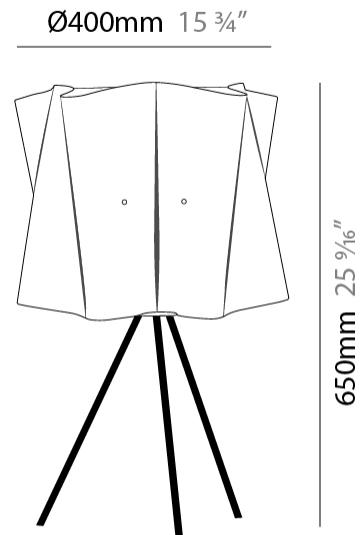

## FOLIO PORTABLE

D64009-

PROJECT	_____
TYPE	_____
SPECIFIER	_____
QUANTITY	_____
DATE	_____

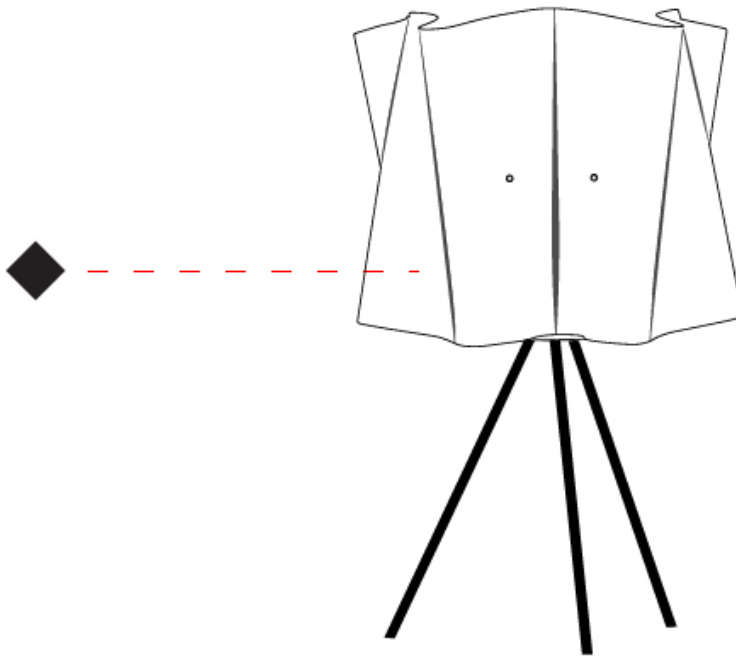

D

## FOLIO PORTABLE

### D64010-

base number            Finish             
Options           

- To build a product code in our configurator select the specify button on the base model # product page
- To build a manual product code on this datasheet choose from the options listed below in blue font and add the suffix to the base model #

#### GENERAL

Series: Folio             
Brand: Linea Zero             
Division: Design             
Mounting Type: Portable             
Mounting Location: Floor             
Subcategory: Ambient           

#### PHYSICAL

Shape: Cylinder             
Diameter (mm): 400             
Diameter (in): 15 ¾             
Height (mm): 1640             
Height (in): 64 9/16             
Light Distribution: Omnidirectional             
Diffuser: Polilux™ Shade - See Finish Options             
[Fixture Finish: WHI / PNK / ORG / VIO / SIL / NGD / COP / PKM](#)             
Fixture Material: Polilux™/ Metal holder             
Upon Request: Bolt Down           

#### ELECTRICAL

Number of Lamps: 1             
Lamp Type: LED Retrofit             
Bulb Included: Bulb Not Included             
Max. Wattage Per Lamp (W): 7             
Lamp Base: E26             
Input Voltage (V): 120             
Lamp Voltage (V): 120             
Upon Request: 277Vac / GU24           

#### LED

#### OPTICAL

#### RATINGS AND CERTIFICATIONS

Certified By: Certified for North American Standards             
IP rating: IP20           

PROJECT	_____
TYPE	_____
SPECIFIER	_____
QUANTITY	_____
DATE	_____



Ø400mm 15 ¾"

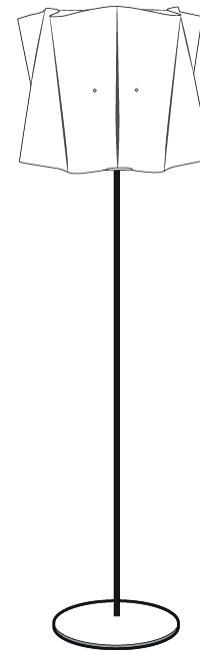

1640mm 64 9/16"



## FOLIO PORTABLE

D64010-

PROJECT	_____
TYPE	_____
SPECIFIER	_____
QUANTITY	_____
DATE	_____

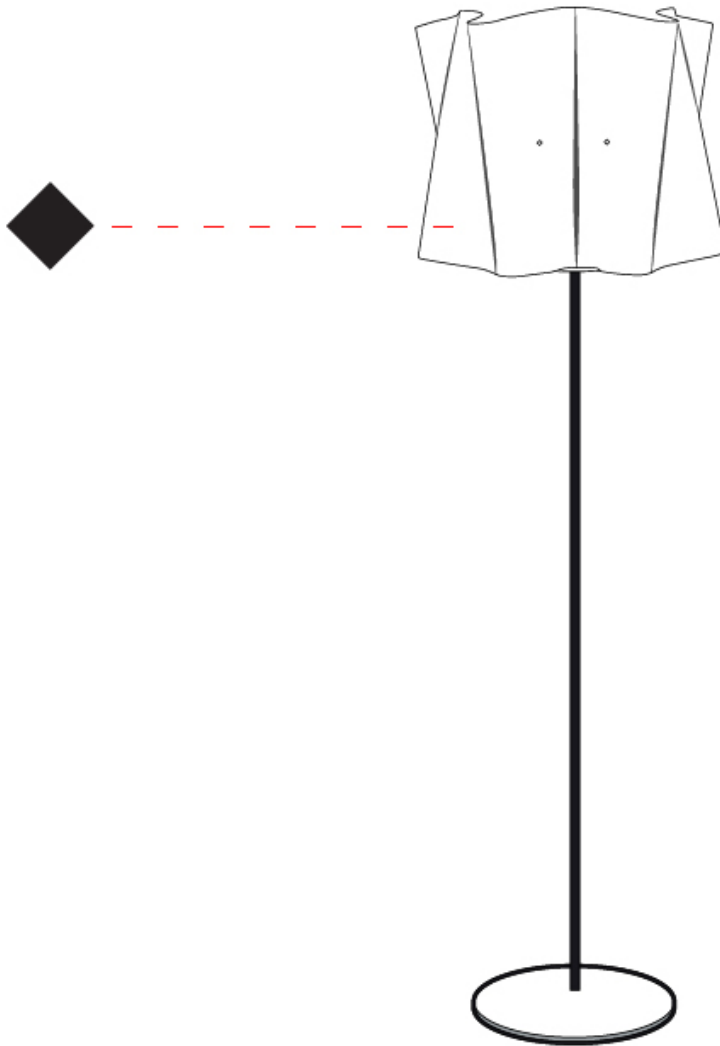



PROJECT
TYPE
SPECIFIER
QUANTITY
DATE

## FOLIO PORTABLE

### D64011-

base number            Finish             
Options           

- To build a product code in our configurator select the specify button on the base model # product page
- To build a manual product code on this datasheet choose from the options listed below in blue font and add the suffix to the base model #

#### GENERAL

Series: Folio             
 Brand: Linea Zero             
 Division: Design             
 Mounting Type: Portable             
 Mounting Location: Floor             
 Subcategory: Ambient           

#### PHYSICAL

Shape: Abstract             
 Diameter (mm): 400             
 Diameter (in): 15 3/4             
 Height (mm): 1570             
 Height (in): 61 13/16             
 Light Distribution: Omnidirectional             
 Diffuser: Polilux™ Shade - See Finish Options             
 Fixture Finish: WHI / PNK / ORG / VIO / SIL / NGD / COP / PKM             
 Fixture Material: Polilux™/ Metal holder           

#### ELECTRICAL

Number of Lamps: 1             
 Lamp Type: LED Retrofit             
 Bulb Included: Bulb Not Included             
 Max. Wattage Per Lamp (W): 7             
 Lamp Base: E26             
 Input Voltage (V): 120             
 Lamp Voltage (V): 120             
 Upon Request: 277Vac / GU24           

#### LED

#### OPTICAL

#### RATINGS AND CERTIFICATIONS

Certified By: Certified for North American Standards             
 IP rating: IP20           



Ø400mm 15 3/4"

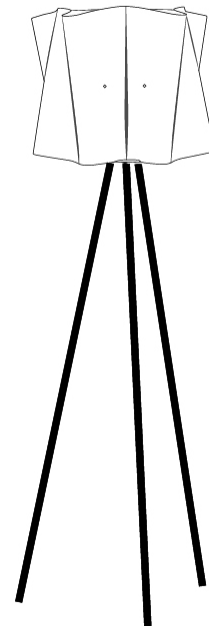

1570mm 61 13/16"



## FOLIO PORTABLE

D64011-

PROJECT

TYPE

SPECIFIER

QUANTITY

DATE

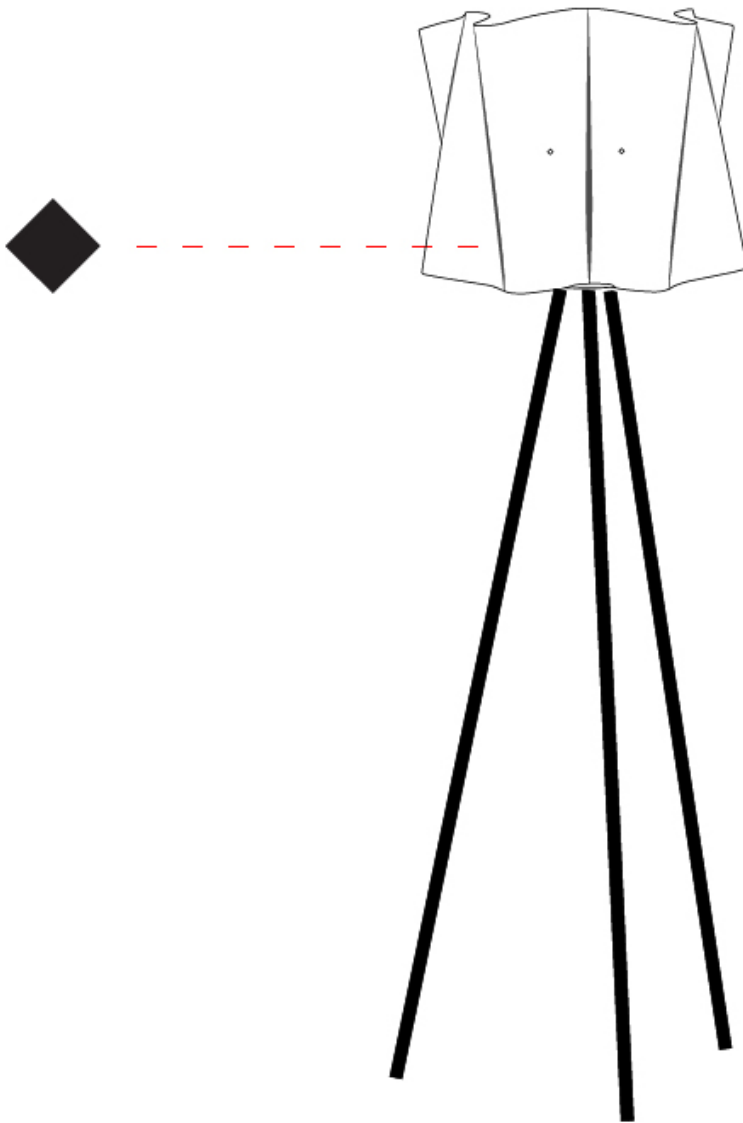

D

PROJECT	_____
TYPE	_____
SPECIFIER	_____
QUANTITY	_____
DATE	_____

### Fixture Finish

White - WHI



Pink - PNK



Orange - ORG



Violet - VIO



Silver - SIL



New Gold - NGD



Copper - COP



Pink Metal - PKM



Black - BLK

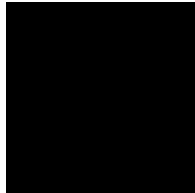

**Digital:** Not all screens are calibrated the same, and therefore, colors will appear differently between screens.

**Physical:** When texture is involved, there will be variations in color, character and tone within a product series and between product families.



PROJECT	
TYPE	
SPECIFIER	
QUANTITY	
DATE	

### LEGEND

floor-mounted	pivotal	special LED (upon request) RGB, RGBW, tunable, gold+, meat+, art+, fashion+
wall and ceiling: recessed and surface mounted	rotating	warm dim / natural dimming LED
ceiling-mounted and wall-mounted	illuminate tilted	rechargeable battery powered
wall-mounted	color of suspension cable	fixture with natural vivid LED (upon request)
omni-directional light distribution	length of suspension cable	color rendering index
direct light distribution	reflector degree selection	color temperature
direct/indirect light distribution	super spot	lumen (luminous flux)
indirect light distribution	lens	efficacy (lumens per watt)
asymmetric light distribution	lens pack	Unified Glare Rating (UGR) range from 5-40
aura light distribution	shine ring	marine grade (AISI 316 stainless steel)
round wall or ceiling cut-out	integrated shine ring with diffuser	walk on
square wall or ceiling cut-out	free individual colors 01-29	drive on
the supplied jig specifies the cutout dimensions	individual colors: 00 (free of charge), 01-25 (extra charge)	Dark Sky Compliance
minimum distance (meters) lamp - object	luminaire part to be colored (F1)	Americans with Disabilities Act (less than 4" off the wall located between 27"-84" from floor)
recessed depth	luminaire part to be colored (F2)	lamp protected against explosion
ceiling thickness in mm	luminaire part to be colored (F3)	blown glass using traditional methods by master glass blower
ceiling thickness selection	luminaire part to be colored (F4)	acoustic material
dimmable DP (phase), DV (0-10V), DD (dali), DS (step-dim)	luminaire part to be colored (F5)	protection class I, protection insulation
included or excluded LED driver/transformer/control gear	color of 3-circuit adaptor	protection class II, protection insulation
separately switchable	indirect diffuser	ETL Certified to UL and CSA Standards
sensor	direct diffuser	UL Certified to UL and CSA Standards
remote control	ball-proof (upon request)	CSA Certified to UL and CSA Standards
available upon request	accessory	Certified for North American Standards

### IP RATING

IP20	protected against ingress of solid bodies greater than 12.5mm (finger)
IP33	protected against ingress of solid bodies greater than 2.5mm protected against sprays of water up to 60 degrees from the vertical (rain)
IP40	protected against ingress of solid bodies greater than 1mm (wire) no protection against the ingress of moisture
IP43	protected against ingress of solid bodies greater than 1mm (wire) protected against sprays of water up to 60 degrees from the vertical (rain)
IP44	protected against ingress of solid bodies greater than 1mm (wire) protected against water splashed from all directions
IP54	protected against limited ingress of dust (wet rooms/covered outdoor areas) protected against water splashed from all directions
IP65	protected against ingress of dust protected against jets of water
IP66	protected against ingress of dust protected against powerful jets of water or heavy seas
IP67	protected against ingress of dust protected against immersion of water between 15cm - 1m for 30 minutes
IP68	protected against ingress of dust protected against immersion of water under pressure for long periods

### IK RATING

IK01	protected against 0.14 joules impact (equivalent to 0.25kg mass dropped from 56mm above the surface)
IK02	protected against 0.2 joules impact (equivalent to 0.25kg mass dropped from 80mm above the surface)
IK03	protected against 0.35 joules impact (equivalent to 0.25kg mass dropped from 140mm above the surface)
IK04	protected against 0.5 joules impact (equivalent to 0.25kg mass dropped from 200mm above the surface)
IK05	protected against 0.7 joules impact (equivalent to 0.25kg mass dropped from 280mm above the surface)
IK06	protected against 1 joules impact (equivalent to 0.25kg mass dropped from 400mm above the surface)
IK07	protected against 2 joules impact (equivalent to 0.5kg mass dropped from 400mm above the surface)
IK08	protected against 5 joules impact (equivalent to 1.7kg mass dropped from 300mm above the surface)
IK09	protected against 10 joules impact (equivalent to 5.0kg mass dropped from 200mm above the surface)
IK10	protected against 20 joules impact (equivalent to 5.0kg mass dropped from 400mm above the surface)