

## GOCCIA MONOPOINT SUSPENSION

### D141065-

base number                      Finish                       
Options                     

- To build a product code in our configurator select the specify button on the base model # product page
- To build a manual product code on this datasheet choose from the options listed below in blue font and add the suffix to the base model #

#### GENERAL

Series: Goccia                       
Subseries: Goccia Monopoint                       
Brand: Cangini & Tucci                       
Division: Design                       
Mounting Type: Suspension                       
Mounting Location: Ceiling                     

#### PHYSICAL

Shape: Abstract                       
Diameter (mm): 180                       
Diameter (in): 7 1/16                       
Height (mm): 320                       
Height (in): 12 5/8                       
Max. Overall Height (mm): 1820                       
Max. Overall Height (in): 71 5/8                       
Light Distribution: Omnidirectional                       
Weight (kg): 0.82                       
Weight (lbs): 1.81                       
[Fixture Finish: AMB / GRN / PNK / RUB / SKB / SMK / TOB / TRA](#)                       
Holder Finish: CHR                       
Fixture Material: Glass / Metal                       
Cable Details: 1500mm Cable                     

#### ELECTRICAL

Number of Lamps: 1                       
Lamp Type: LED Retrofit                       
Bulb Included: Bulb Not Included                       
Max. Wattage Per Lamp (W): 4                       
Lamp Base: E12                       
Input Voltage (V): 120                     

#### LED

#### OPTICAL

#### RATINGS AND CERTIFICATIONS

Certified By: Certified for North American Standards                       
IP rating: IP20                     

PROJECT	_____
TYPE	_____
SPECIFIER	_____
QUANTITY	_____
DATE	_____

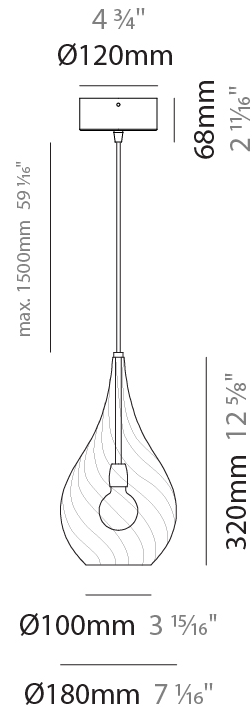

## GOCCIA MONOPOINT SUSPENSION

D141065-

PROJECT

TYPE

SPECIFIER

QUANTITY

DATE

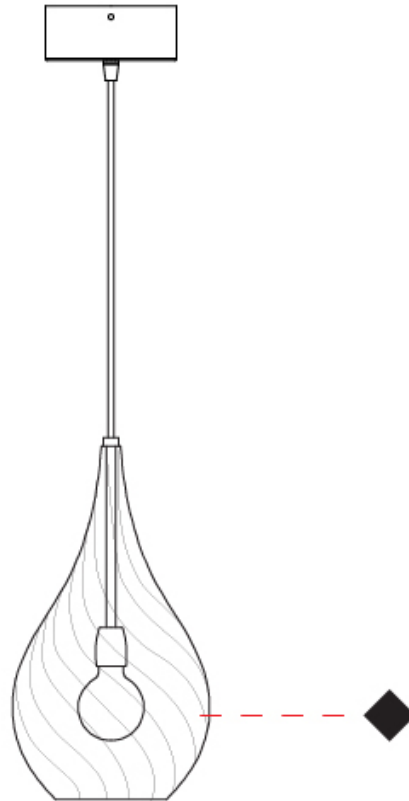

D

## GOCCIA MONOPOINT SUSPENSION

### D141066-

base number Finish  
Options

- To build a product code in our configurator select the specify button on the base model # product page
- To build a manual product code on this datasheet choose from the options listed below in blue font and add the suffix to the base model #

#### GENERAL

Series: Goccia  
Subseries: Goccia Monopoint  
Brand: Cangini & Tucci  
Division: Design  
Mounting Type: Suspension  
Mounting Location: Ceiling

#### PHYSICAL

Shape: Abstract  
Diameter (mm): 260  
Diameter (in): 10 ¼  
Height (mm): 420  
Height (in): 16 ⅙  
Max. Overall Height (mm): 1920  
Max. Overall Height (in): 75 ⅙  
Light Distribution: Omnidirectional  
Weight (kg): 1.085  
Weight (lbs): 2.39  
[Fixture Finish: AMB / GRN / PNK / RUB / SKB / SMK / TOB / TRA](#)  
Holder Finish: CHR  
Fixture Material: Glass / Metal  
Cable Details: 1500mm Cable

#### ELECTRICAL

Number of Lamps: 1  
Lamp Type: LED Retrofit  
Bulb Included: Bulb Not Included  
Max. Wattage Per Lamp (W): 8  
Lamp Base: E26  
Input Voltage (V): 120  
Upon Request: 277Vac / GU24

#### LED

#### OPTICAL

#### RATINGS AND CERTIFICATIONS

Certified By: Certified for North American Standards  
IP rating: IP20

PROJECT
TYPE
SPECIFIER
QUANTITY
DATE

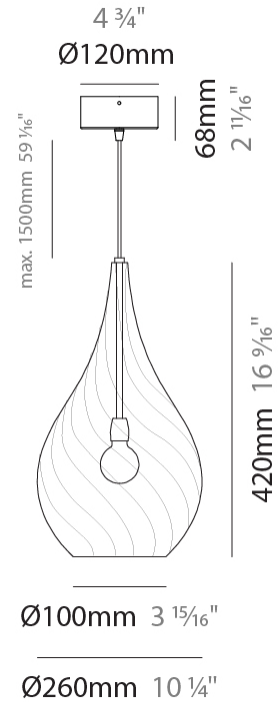

## GOCCIA MONOPOINT SUSPENSION

D141066-

PROJECT

TYPE

SPECIFIER

QUANTITY

DATE

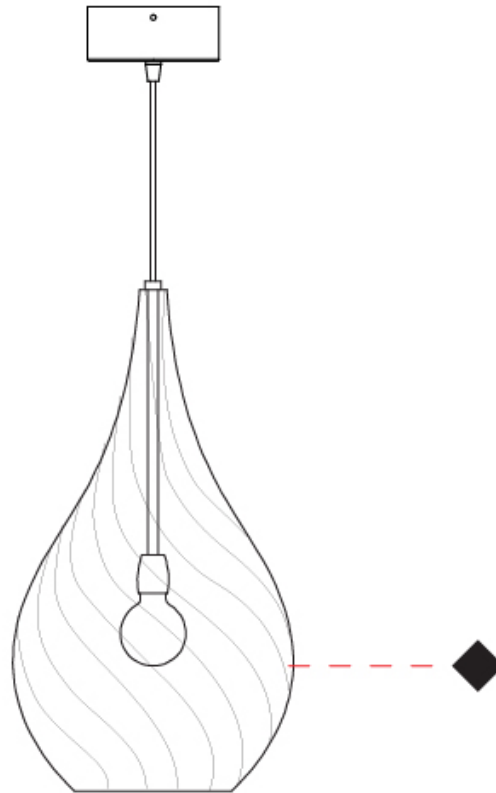

D

PROJECT	_____
TYPE	_____
SPECIFIER	_____
QUANTITY	_____
DATE	_____

## GOCCIA 2 LIGHT SWAG SUSPENSION

### D141072-

base number            Finish             
Options           

- To build a product code in our configurator select the specify button on the base model # product page
- To build a manual product code on this datasheet choose from the options listed below in blue font and add the suffix to the base model #

#### GENERAL

Series: Goccia  
 Subseries: Goccia 2 Light Swag  
 Brand: Cangini & Tucci  
 Division: Design  
 Mounting Type: Suspension  
 Mounting Location: Ceiling

#### PHYSICAL

Shape: Abstract  
 Diameter (mm): 180  
 Diameter (in): 7 1/16  
 Height (mm): 320  
 Height (in): 12 5/8  
 Max. Overall Height (mm): 1820  
 Max. Overall Height (in): 71 5/8  
 Light Distribution: Omnidirectional  
 Weight (kg): 1.54  
 Weight (lbs): 3.39  
 Fixture Finish: [AMB / GRN / PNK / RUB / SKB / SMK / TOB / TRA](#)  
 Holder Finish: CHR  
 Fixture Material: Glass / Metal  
 Cable Details: 1500mm Cable

#### ELECTRICAL

Number of Lamps: 2  
 Lamp Type: LED Retrofit  
 Bulb Included: Bulb Not Included  
 Total Output Wattage (W): 8  
 Max. Wattage Per Lamp (W): 4  
 Lamp Base: E12  
 Input Voltage (V): 120

#### LED

#### OPTICAL

#### RATINGS AND CERTIFICATIONS

Certified By: Certified for North American Standards  
 IP rating: IP20

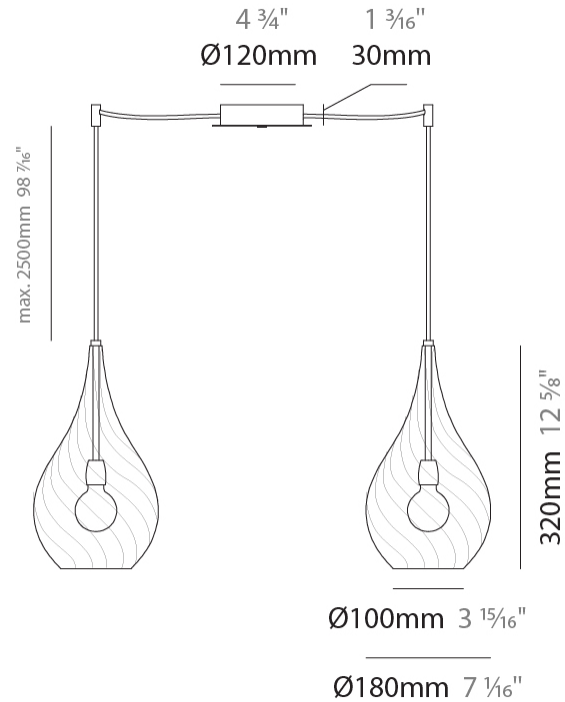

## GOCCIA 2 LIGHT SWAG SUSPENSION

D141072-

PROJECT	_____
TYPE	_____
SPECIFIER	_____
QUANTITY	_____
DATE	_____

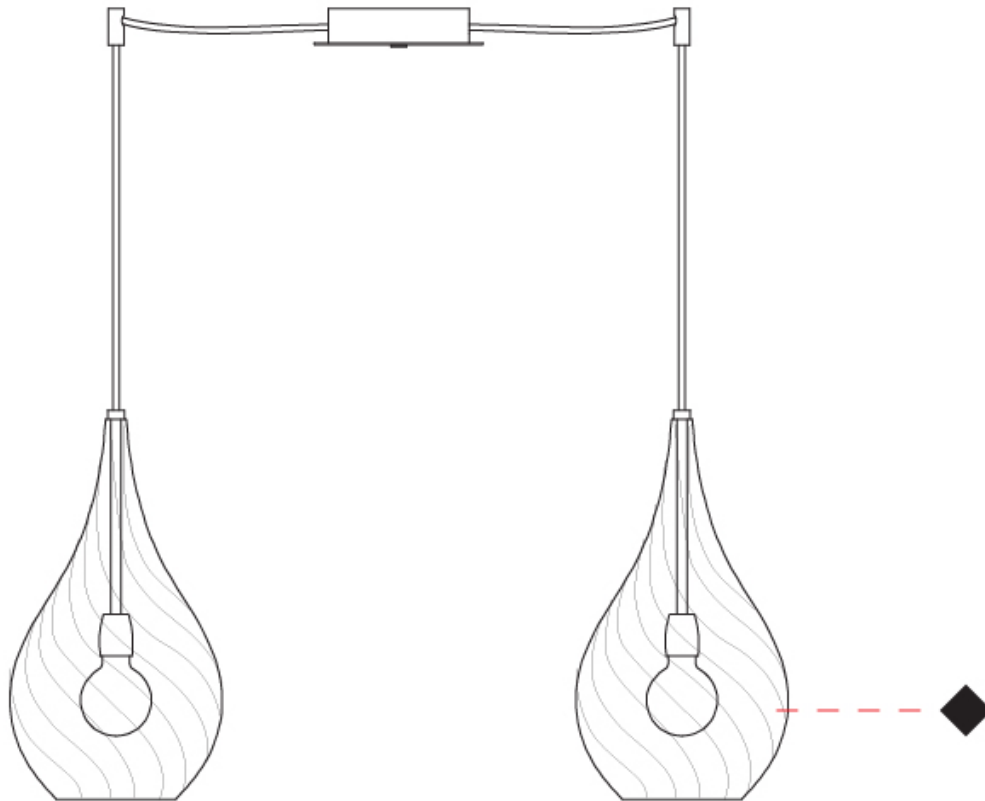

D

PROJECT	
TYPE	
SPECIFIER	
QUANTITY	
DATE	

## GOCCIA 3 LIGHT LINEAR SUSPENSION

### D141073-

base number Finish  
Options

- To build a product code in our configurator select the specify button on the base model # product page
- To build a manual product code on this datasheet choose from the options listed below in blue font and add the suffix to the base model #

#### GENERAL

Series: Goccia  
 Subseries: Goccia 3 Light Linear  
 Brand: Cangini & Tucci  
 Division: Design  
 Mounting Type: Suspension  
 Mounting Location: Ceiling

#### PHYSICAL

Shape: Abstract  
 Length (mm): 1200  
 Length (in): 47 1/4  
 Height (mm): 320  
 Height (in): 12 5/8  
 Max. Overall Height (mm): 1820  
 Max. Overall Height (in): 71 5/8  
 Light Distribution: Omnidirectional  
 Weight (kg): 3.4  
 Weight (lbs): 7.48  
[Fixture Finish: AMB / GRN / PNK / RUB / SKB / SMK / TOB / TRA](#)  
 Holder Finish: PSS  
 Fixture Material: Glass / Metal  
 Cable Details: 1500mm Cable

#### ELECTRICAL

Number of Lamps: 3  
 Lamp Type: LED Retrofit  
 Bulb Included: Bulb Not Included  
 Total Output Wattage (W): 12  
 Max. Wattage Per Lamp (W): 4  
 Lamp Base: E12  
 Input Voltage (V): 120

#### LED

#### OPTICAL

#### RATINGS AND CERTIFICATIONS

Certified By: Certified for North American Standards  
 IP rating: IP20

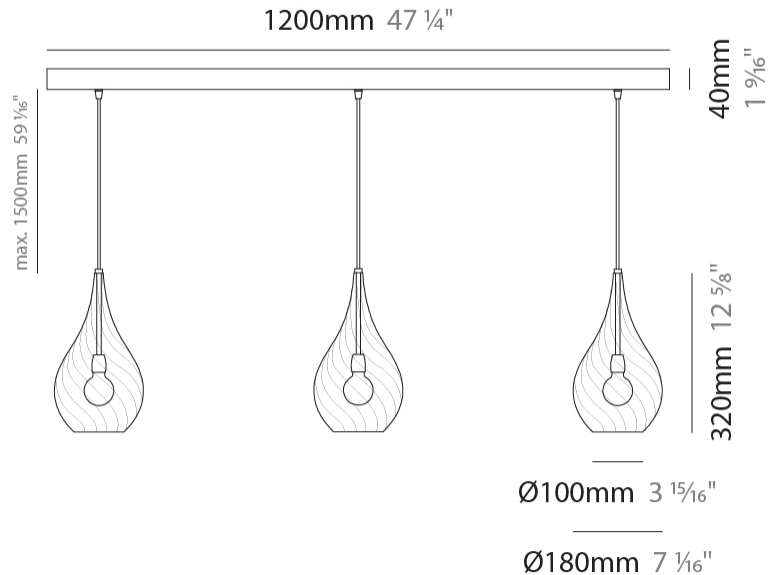

## GOCCIA 3 LIGHT LINEAR SUSPENSION

D141073-

PROJECT \_\_\_\_\_

TYPE \_\_\_\_\_

SPECIFIER \_\_\_\_\_

QUANTITY \_\_\_\_\_

DATE \_\_\_\_\_

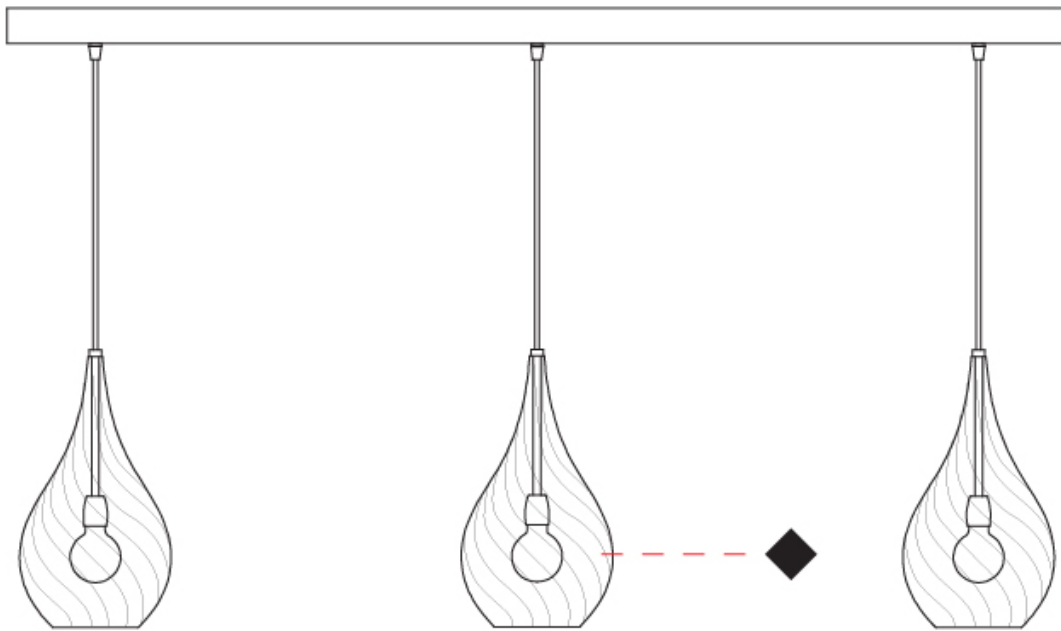

D



PROJECT	
TYPE	
SPECIFIER	
QUANTITY	
DATE	

## GOCCIA 3 LIGHT CLUSTER SUSPENSION

### D141074-

base number Finish  
Options

- To build a product code in our configurator select the specify button on the base model # product page
- To build a manual product code on this datasheet choose from the options listed below in blue font and add the suffix to the base model #

#### GENERAL

Series: Goccia  
 Subseries: Goccia 3 Light Cluster  
 Brand: Cangini & Tucci  
 Division: Design  
 Mounting Type: Suspension  
 Mounting Location: Ceiling

#### PHYSICAL

Shape: Abstract  
 Length (mm): 430  
 Length (in): 16 <sup>15</sup>/<sub>16</sub>  
 Max. Overall Height (mm): 1500  
 Max. Overall Height (in): 59 <sup>7</sup>/<sub>16</sub>  
 Light Distribution: Omnidirectional  
 Weight (kg): 4.6  
 Weight (lbs): 10.12  
 Fixture Finish: [AMB](#) / [GRN](#) / [PNK](#) / [RUB](#) / [SKB](#) / [SMK](#) / [TOB](#) / [TRA](#)  
 Holder Finish: PSS  
 Fixture Material: Glass / Metal  
 Cable Details: 1500mm Cable

#### ELECTRICAL

Number of Lamps: 3  
 Lamp Type: LED Retrofit  
 Bulb Included: Bulb Not Included  
 Total Output Wattage (W): 16  
 Max. Wattage Per Lamp (W): 8 + 8  
 Lamp Base: E26 + E12  
 Input Voltage (V): 120

#### LED

#### OPTICAL

#### RATINGS AND CERTIFICATIONS

Certified By: Certified for North American Standards  
 IP rating: IP20

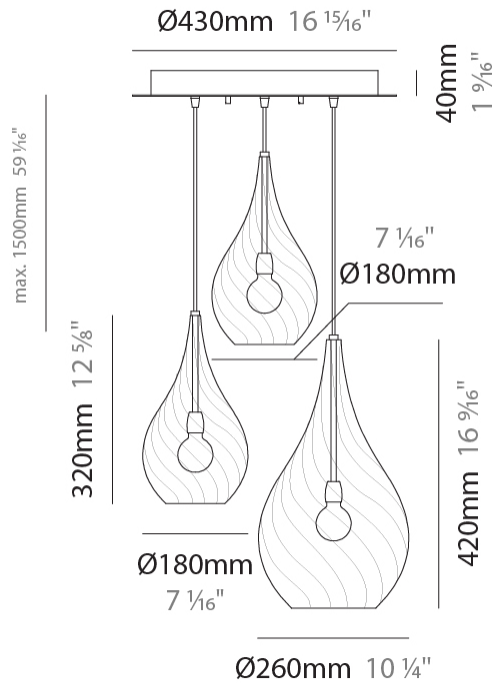

## GOCCIA 3 LIGHT CLUSTER SUSPENSION

D141074-

PROJECT

TYPE

SPECIFIER

QUANTITY

DATE

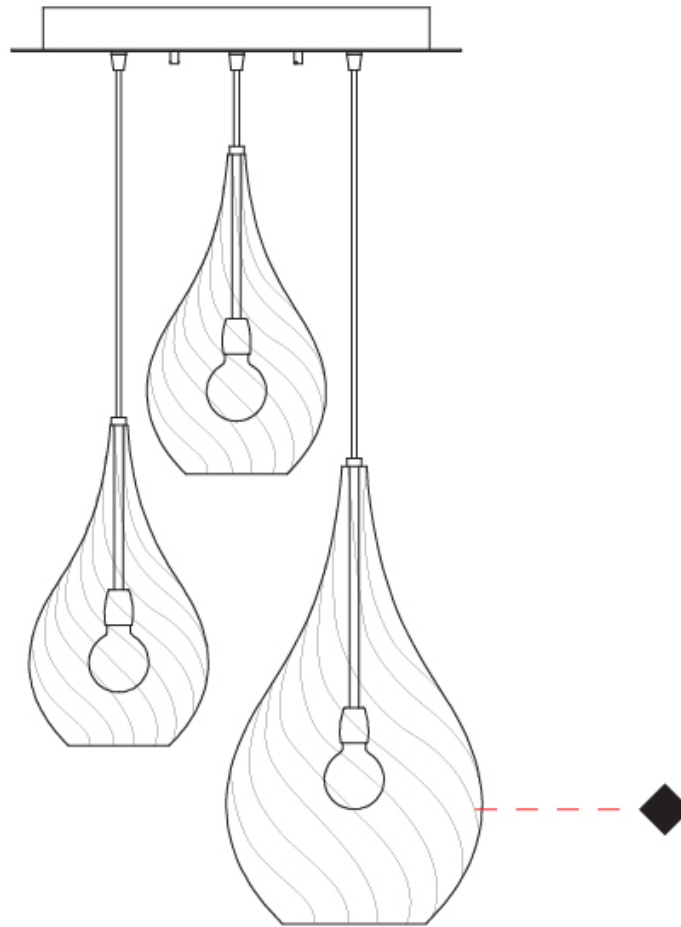

D

PROJECT
TYPE
SPECIFIER
QUANTITY
DATE

## GOCCIA PORTABLE

### D144006-

base number                      Finish                       
Options                     

- To build a product code in our configurator select the specify button on the base model # product page
- To build a manual product code on this datasheet choose from the options listed below in blue font and add the suffix to the base model #

#### GENERAL

Series: Goccia                       
 Brand: Cangiini & Tucci                       
 Division: Design                       
 Mounting Type: Portable                       
 Mounting Location: Table                     

#### PHYSICAL

Shape: Abstract                       
 Diameter (mm): 300                       
 Diameter (in): 11 <sup>13</sup>/<sub>16</sub>                       
 Height (mm): 550                       
 Height (in): 21 <sup>5</sup>/<sub>8</sub>                       
 Light Distribution: Omnidirectional                       
 Weight (kg): 0.97                       
 Weight (lbs): 2.13                       
 Fixture Finish: [AMB](#) / [GRN](#) / [PNK](#) / [RUB](#) / [SKB](#) / [SMK](#) / [TOB](#) / [TRA](#)                       
 Holder Finish: CHR                       
 Fixture Material: Glass / Metal                       
 Cable Details: 1500mm Cable                     

#### ELECTRICAL

Number of Lamps: 1                       
 Lamp Type: LED Retrofit                       
 Bulb Included: Bulb Not Included                       
 Max. Wattage Per Lamp (W): 4                       
 Lamp Base: E12                       
 Input Voltage (V): 120                     

#### LED

#### OPTICAL

#### RATINGS AND CERTIFICATIONS

Certified By: Certified for North American Standards                       
 IP rating: IP20                     



Ø300mm 11 <sup>13</sup>/<sub>16</sub>"

Ø200mm 7 <sup>7</sup>/<sub>8</sub>"

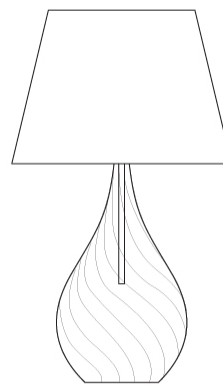

210mm 8 <sup>1</sup>/<sub>4</sub>"

550mm 21 <sup>5</sup>/<sub>8</sub>"

Ø180mm 7 <sup>1</sup>/<sub>16</sub>"



D144006-

PROJECT

TYPE

SPECIFIER

QUANTITY

DATE

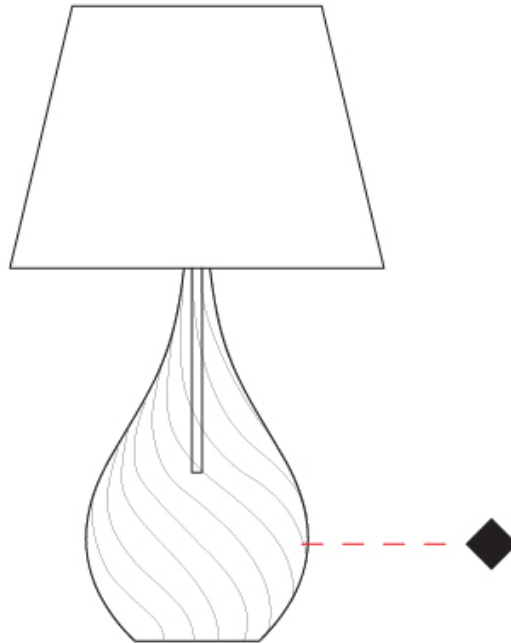

D

## GOCCIA PORTABLE

**D144007-**

base number                      Finish                       
Options                     

PROJECT	_____
TYPE	_____
SPECIFIER	_____
QUANTITY	_____
DATE	_____

- To build a product code in our configurator select the specify button on the base model # product page
- To build a manual product code on this datasheet choose from the options listed below in blue font and add the suffix to the base model #

### GENERAL

Series: Goccia \_\_\_\_\_  
 Brand: Cangini & Tucci \_\_\_\_\_  
 Division: Design \_\_\_\_\_  
 Mounting Type: Portable \_\_\_\_\_  
 Mounting Location: Table \_\_\_\_\_

### PHYSICAL

Shape: Abstract \_\_\_\_\_  
 Diameter (mm): 400 \_\_\_\_\_  
 Diameter (in): 15 <sup>3</sup>/<sub>4</sub> \_\_\_\_\_  
 Height (mm): 700 \_\_\_\_\_  
 Height (in): 27 <sup>9</sup>/<sub>16</sub> \_\_\_\_\_  
 Light Distribution: Omnidirectional \_\_\_\_\_  
 Weight (kg): 1.48 \_\_\_\_\_  
 Weight (lbs): 3.26 \_\_\_\_\_  
 Fixture Finish: [AMB](#) / [GRN](#) / [PNK](#) / [RUB](#) / [SKB](#) / [SMK](#) / [TOB](#) / [TRA](#) \_\_\_\_\_  
 Holder Finish: CHR \_\_\_\_\_  
 Fixture Material: Glass / Metal \_\_\_\_\_  
 Cable Details: 1500mm Cable \_\_\_\_\_

### ELECTRICAL

Number of Lamps: 1 \_\_\_\_\_  
 Lamp Type: LED Retrofit \_\_\_\_\_  
 Bulb Included: Bulb Not Included \_\_\_\_\_  
 Max. Wattage Per Lamp (W): 8 \_\_\_\_\_  
 Lamp Base: E26 \_\_\_\_\_  
 Input Voltage (V): 120 \_\_\_\_\_  
 Upon Request: 277Vac / GU24 \_\_\_\_\_

### LED

### OPTICAL

### RATINGS AND CERTIFICATIONS

Certified By: Certified for North American Standards \_\_\_\_\_  
 IP rating: IP20 \_\_\_\_\_

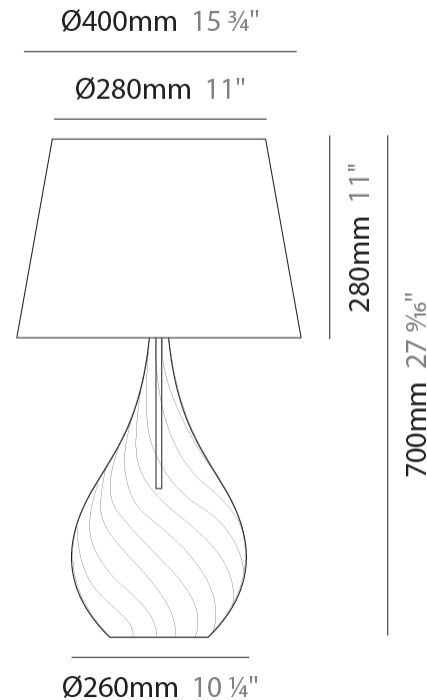

D144007-

PROJECT

TYPE

SPECIFIER

QUANTITY

DATE

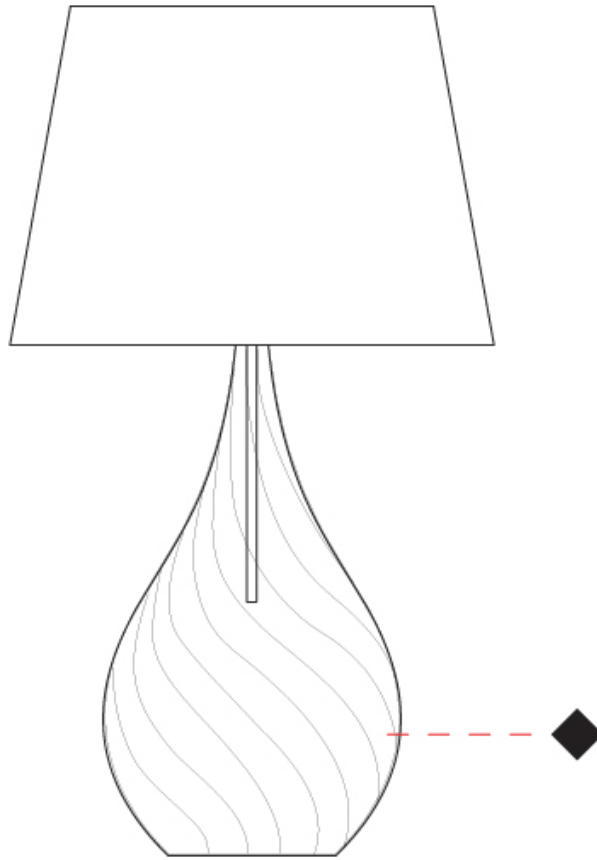

D

PROJECT	_____
TYPE	_____
SPECIFIER	_____
QUANTITY	_____
DATE	_____

### Fixture Finish

Amber - AMB



Green - GRN



Pink - PNK



Ruby - RUB



Sky Blue - SKB



Smoke - SMK



Tobacco - TOB



Transparent - TRA



### Holder Finish

Chrome - CHR



Polished Stainless Steel - PSS

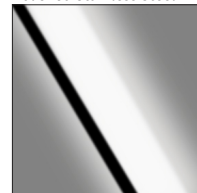

**Digital:** Not all screens are calibrated the same, and therefore, colors will appear differently between screens.

**Physical:** When texture is involved, there will be variations in color, character and tone within a product series and between product families.

PROJECT	
TYPE	
SPECIFIER	
QUANTITY	
DATE	

### LEGEND

floor-mounted	pivotal	special LED (upon request) RGB, RGBW, tunable, gold+, meat+, art+, fashion+
wall and ceiling: recessed and surface mounted	rotating	warm dim / natural dimming LED
ceiling-mounted and wall-mounted	illuminate tilted	rechargeable battery powered
wall-mounted	color of suspension cable	fixture with natural vivid LED (upon request)
omni-directional light distribution	length of suspension cable	color rendering index
direct light distribution	reflector degree selection	color temperature
direct/indirect light distribution	super spot	lumen (luminous flux)
indirect light distribution	lens	efficacy (lumens per watt)
asymmetric light distribution	lens pack	Unified Glare Rating (UGR) range from 5-40
aura light distribution	shine ring	marine grade (AISI 316 stainless steel)
round wall or ceiling cut-out	integrated shine ring with diffuser	walk on
square wall or ceiling cut-out	free individual colors 01-29	drive on
the supplied jig specifies the cutout dimensions	individual colors: 00 (free of charge), 01-25 (extra charge)	Dark Sky Compliance
minimum distance (meters) lamp - object	luminaire part to be colored (F1)	Americans with Disabilities Act (less than 4" off the wall located between 27"-84" from floor)
recessed depth	luminaire part to be colored (F2)	lamp protected against explosion
ceiling thickness in mm	luminaire part to be colored (F3)	blown glass using traditional methods by master glass blower
ceiling thickness selection	luminaire part to be colored (F4)	acoustic material
dimmable DP (phase), DV (0-10V), DD (dali), DS (step-dim)	luminaire part to be colored (F5)	protection class I, protection insulation
included or excluded LED driver/transformer/control gear	color of 3-circuit adaptor	protection class II, protection insulation
separately switchable	indirect diffuser	ETL Certified to UL and CSA Standards
sensor	direct diffuser	UL Certified to UL and CSA Standards
remote control	ball-proof (upon request)	CSA Certified to UL and CSA Standards
available upon request	accessory	Certified for North American Standards

### IP RATING

IP20	protected against ingress of solid bodies greater than 12.5mm (finger)
IP33	protected against ingress of solid bodies greater than 2.5mm protected against sprays of water up to 60 degrees from the vertical (rain)
IP40	protected against ingress of solid bodies greater than 1mm (wire) no protection against the ingress of moisture
IP43	protected against ingress of solid bodies greater than 1mm (wire) protected against sprays of water up to 60 degrees from the vertical (rain)
IP44	protected against ingress of solid bodies greater than 1mm (wire) protected against water splashed from all directions
IP54	protected against limited ingress of dust (wet rooms/covered outdoor areas) protected against water splashed from all directions
IP65	protected against ingress of dust protected against jets of water
IP66	protected against ingress of dust protected against powerful jets of water or heavy seas
IP67	protected against ingress of dust protected against immersion of water between 15cm - 1m for 30 minutes
IP68	protected against ingress of dust protected against immersion of water under pressure for long periods

### IK RATING

IK01	protected against 0.14 joules impact (equivalent to 0.25kg mass dropped from 56mm above the surface)
IK02	protected against 0.2 joules impact (equivalent to 0.25kg mass dropped from 80mm above the surface)
IK03	protected against 0.35 joules impact (equivalent to 0.25kg mass dropped from 140mm above the surface)
IK04	protected against 0.5 joules impact (equivalent to 0.25kg mass dropped from 200mm above the surface)
IK05	protected against 0.7 joules impact (equivalent to 0.25kg mass dropped from 280mm above the surface)
IK06	protected against 1 joules impact (equivalent to 0.25kg mass dropped from 400mm above the surface)
IK07	protected against 2 joules impact (equivalent to 0.5kg mass dropped from 400mm above the surface)
IK08	protected against 5 joules impact (equivalent to 1.7kg mass dropped from 300mm above the surface)
IK09	protected against 10 joules impact (equivalent to 5.0kg mass dropped from 200mm above the surface)
IK10	protected against 20 joules impact (equivalent to 5.0kg mass dropped from 400mm above the surface)