

PROJECT
TYPE
SPECIFIER
QUANTITY
DATE

## HANGOVER PLUG MONOPOINT RECESSED CANOPY SUSPENSION

### A30841-

base number	Color Temperature	Finishes (Diamond)	Finishes (Triangle)	Finishes (Circle)	Lens Options	Cable Options	Lens Options
-------------	-------------------	--------------------	---------------------	-------------------	--------------	---------------	--------------

- To build a product code in our configurator select the specify button on the base model # product page
- To build a manual product code on this datasheet choose from the options listed below in blue font and add the suffix to the base model #

#### GENERAL

Series: Hangover  
 Subseries: Hangover Plug Monopoint Recessed Canopy  
 Brand: Prolicht  
 Division: Architectural  
 Mounting Type: Suspension  
 Mounting Location: Ceiling  
 Subcategory: Pendant

#### PHYSICAL

Shape: Cylinder  
 Diameter (mm): 28  
 Diameter (in): 1 1/8  
 Height (mm): 450  
 Height (in): 17 11/16  
 Max. Overall Height (mm): 2450  
 Max. Overall Height (in): 96 7/16  
 Min. Recessing Depth (mm): 75  
 Min. Recessing Depth (in): 2 15/16  
 Light Distribution: Downlight  
 Weight (kg): 0.389  
 Weight (lbs): 0.856  
 Fixture Finish: SSR / BKV / CWI / CRY / HAB / UFT / ITA / RUA / FTG / MYG / LOD / PUS / FRO / FUP / KIA / POP / BLS / SPG / MEY / GOH / GUM / CHC / COM / ABZ / JAG / OBR / MOS / ROR  
 Accent Finish: NOR / OPL / YEL / ORA / RED / BLU / GRN  
 Fixture Material: Aluminum  
 Cable Details: 2000mm or 4000mm Cable - Black, Green, Orange, Red, White  
 Cut-out Measurements: 68mm / 2 11/16"

#### ELECTRICAL

Lamp Type: LED (Zhaga Standard)  
 Input Wattage (W): 6.4  
 Total Output Wattage (W): 6  
 Dimming: Tri-Mode (Non-Dimming and Phase Dimming (120Vac only) and 0-10V Dimming)  
 Driver Included: Yes  
 Driver Location: External  
 Driver Type: Constant Current - Universal  
 Driver Class: Class 2  
 Housing: ENCP3 w/Quick Connect  
 Input Voltage (V): 120 - 277  
 Constant Current (MA): 500

#### LED

Number of LEDs: 1  
 Color Temperature (°K): 2700 / 3000 / 3500 / 4000  
 Max. Delivered Lumen (lm): Max 381 / 404 / 426 / 438  
 Nominal Lumen (lm): 460 / 487 / 514 / 528  
 CRI: >90 CRI  
 Lamp Life (hrs): 50000

#### OPTICAL

Reflector°: 20 / 26 / 56

#### RATINGS AND CERTIFICATIONS

Certified By: CSA Certified to UL and CSA Standards

IP20 © 2024, T 1800-388-3382, F 416-247-9319, www.zaneen.com

Available for International specifications by adding 'INT' at the end of the existing Model #. For assistance on 'custom' specifications, contact zteam@zaneen.com. In a constant effort to supply the best product, we reserve the right to change specifications or materials without notice. The most recent specification sheets are found at zaneen.com

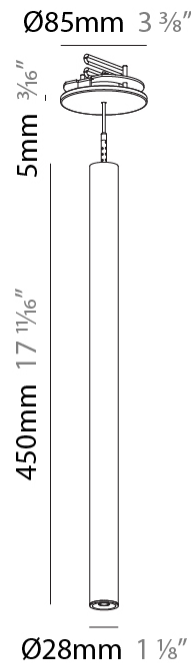
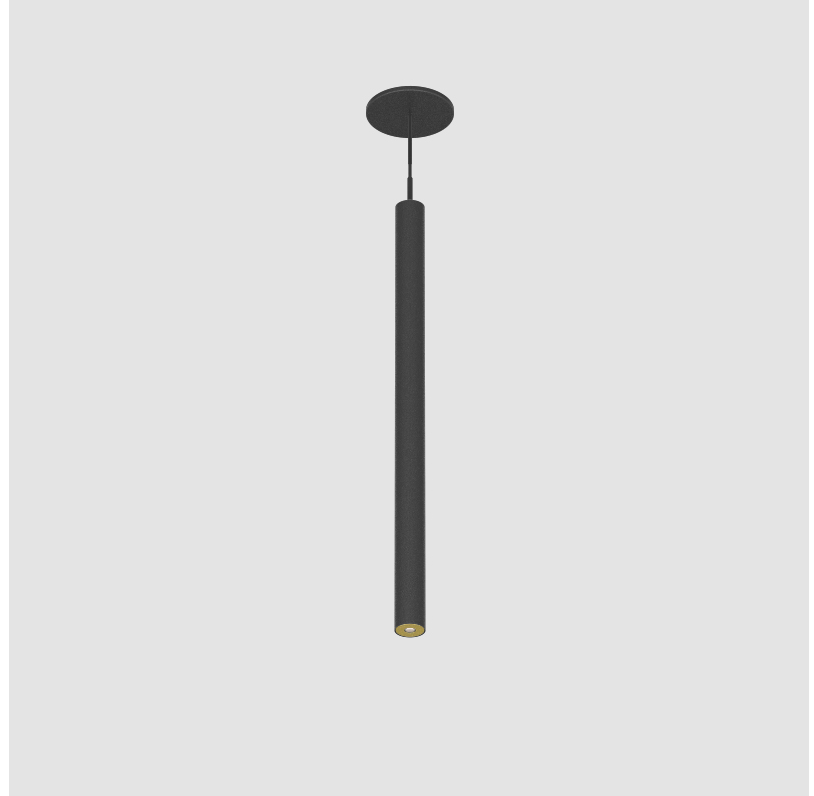

## HANGOVER PLUG MONOPOINT RECESSED CANOPY SUSPENSION

A30841-

PROJECT \_\_\_\_\_

TYPE \_\_\_\_\_

SPECIFIER \_\_\_\_\_

QUANTITY \_\_\_\_\_

DATE \_\_\_\_\_

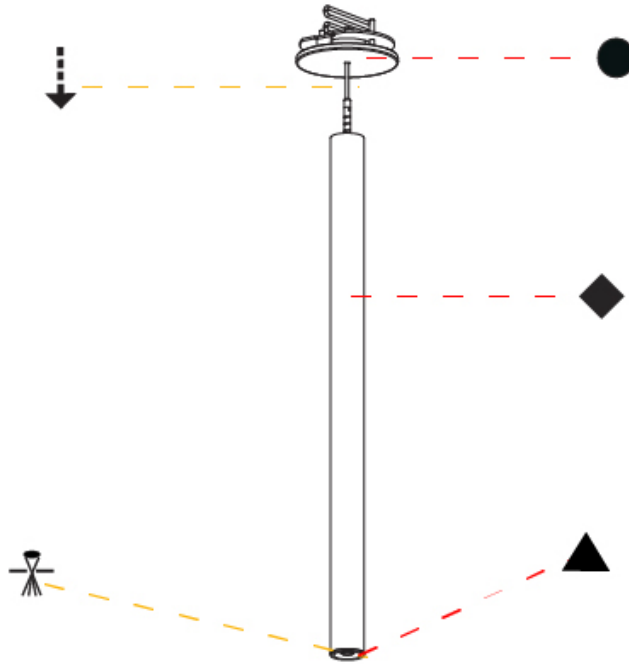

A

PROJECT
TYPE
SPECIFIER
QUANTITY
DATE

## HANGOVER PLUG SHINE MONOPOINT RECESSED CANOPY SUSPENSION

### A30844-

base number	Color	Finishes	Finishes	Finishes	Lens	Shine Ring	Cable
	Temperature	(Diamond)	(Triangle)	(Circle)	Options		Options

- To build a product code in our configurator select the specify button on the base model # product page
- To build a manual product code on this datasheet choose from the options listed below in blue font and add the suffix to the base model #

#### GENERAL

Series: Hangover  
 Subseries: Hangover Plug Shine Monopoint Recessed Canopy  
 Brand: Prolicht  
 Division: Architectural  
 Mounting Type: Suspension  
 Mounting Location: Ceiling  
 Subcategory: Pendant

#### PHYSICAL

Shape: Cylinder  
 Diameter (mm): 28  
 Diameter (in): 1 1/8  
 Height (mm): 450  
 Height (in): 17 11/16  
 Max. Overall Height (mm): 2450  
 Max. Overall Height (in): 96 7/16  
 Min. Recessing Depth (mm): 75  
 Min. Recessing Depth (in): 2 15/16  
 Light Distribution: Downlight  
 Weight (kg): 0.504  
 Weight (lbs): 1.11  
 Diffuser: Shine Ring - Opal / Yellow / Orange / Red / Blue / Green  
 Fixture Finish: SSR / BKV / CWI / CRY / HAB / UFT / ITA / RUA / FTG / MYG / LOD / PUS / FRO / FUP / KIA / POP / BLS / SPG / MEY / GOH / GUM / CHC / COM / ABZ / JAG / OBR / MOS / ROR  
 Fixture Material: Aluminum  
 Cable Details: 2000mm or 4000mm Black Cable  
 Cut-out Measurements: 68mm / 2 11/16"

#### ELECTRICAL

Lamp Type: LED (Zhaga Standard)  
 Input Wattage (W): 6.6  
 Total Output Wattage (W): 6  
 Dimming: Tri-Mode (Non-Dimming and Phase Dimming (120Vac only) and 0-10V Dimming)  
 Driver Included: Yes  
 Driver Location: External  
 Driver Type: Constant Current - Universal  
 Driver Class: Class 2  
 Housing: ENCP3 w/Quick Connect  
 Input Voltage (V): 120 - 277  
 Constant Current (MA): 500

#### LED

Number of LEDs: 1  
 Color Temperature (°K): 2700 / 3000 / 4000  
 Max. Delivered Lumen (lm): 330 / 360 / 380  
 CRI: >90 CRI  
 Efficiency (%): 86  
 Lamp Life (hrs): 50000  
 Upon Request: \*\*\*3500K available in minimum quantities (larger quantities upon request)

#### OPTICAL

Optic°: 24 / 32 / 58

#### RATINGS AND CERTIFICATIONS

Certified By: Certified for North American Standards www.zaneen.com

Apply the International specifications by adding 'INT' at the end of the existing Model #. For assistance on 'custom' specifications, contact zteam@zaneen.com. In a constant effort to supply the best product, we reserve the right to change specifications or materials without notice. The most recent specification sheets are found at zaneen.com

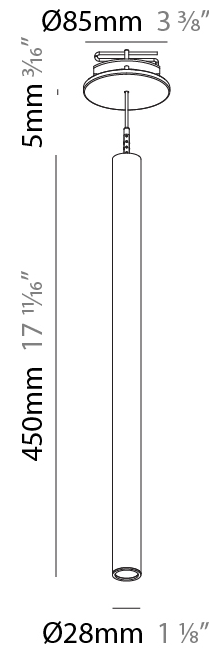

## HANGOVER PLUG SHINE MONOPOINT RECESSED CANOPY SUSPENSION

A30844-

PROJECT

TYPE

SPECIFIER

QUANTITY

DATE

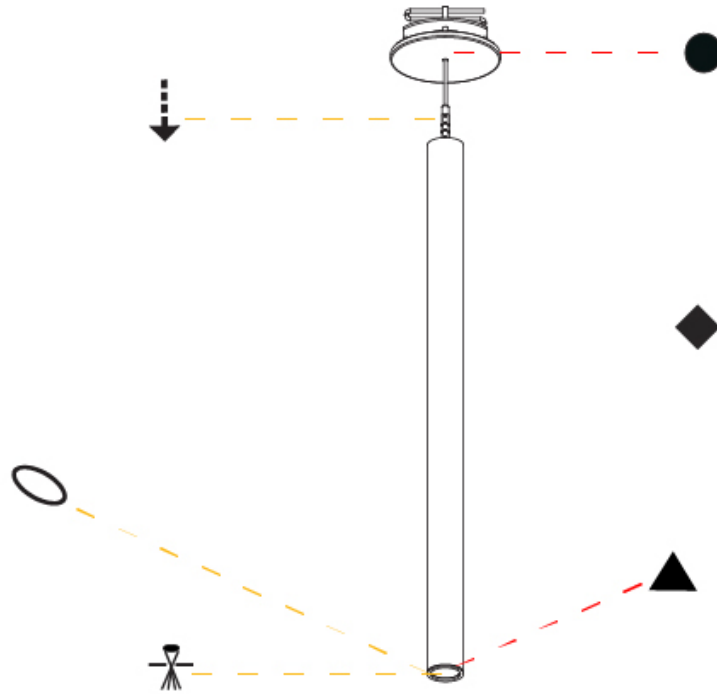

A

PROJECT	_____
TYPE	_____
SPECIFIER	_____
QUANTITY	_____
DATE	_____

## HANGOVER PLUG MONOPOINT SURFACE CANOPY SUSPENSION

### A30846-

base number	Color	Finishes	Finishes	Finishes	Lens	Cable
	Temperature	(Diamond)	(Triangle)	(Circle)	Options	Options

- To build a product code in our configurator select the specify button on the base model # product page
- To build a manual product code on this datasheet choose from the options listed below in blue font and add the suffix to the base model #

#### GENERAL

Series: Hangover  
 Subseries: Hangover Plug Monopoint Surface Canopy  
 Brand: Prolight  
 Division: Architectural  
 Mounting Type: Suspension  
 Mounting Location: Ceiling  
 Subcategory: Pendant

#### PHYSICAL

Shape: Cylinder  
 Diameter (mm): 28  
 Diameter (in): 1 1/8  
 Height (mm): 450  
 Height (in): 17 11/16  
 Max. Overall Height (mm): 2450  
 Max. Overall Height (in): 96 7/16  
 Light Distribution: Downlight  
 Weight (kg): 0.504  
 Weight (lbs): 1.11  
 Fixture Finish: [SSR / BKV / CWI / CRY / HAB / UFT / ITA / RUA / FTG / MYG / LOD / PUS / FRO / FUP / KIA / POP / BLS / SPG / MEY / GOH / GUM / CHC / COM / ABZ / JAG / OBR / MOS / ROR](#)  
 Fixture Material: Aluminum  
 Cable Details: [2000mm or 4000mm Black Cable](#)

#### ELECTRICAL

Lamp Type: LED (Zhaga Standard)  
 Input Wattage (W): 6.6  
 Total Output Wattage (W): 6  
 Dimming: Tri-Mode (Non-Dimming and Phase Dimming (120Vac only) and 0-10V Dimming)  
 Driver Included: Yes  
 Driver Location: External  
 Driver Type: Constant Current - Universal  
 Driver Class: Class 2  
 Housing: ENCP3 w/quick connect  
 Input Voltage (V): 120 - 277  
 Constant Current (MA): 500

#### LED

Number of LEDs: 1  
 Color Temperature (°K): [2700 / 3000 / 4000](#)  
 Max. Delivered Lumen (lm): 330 / 360 / 380  
 CRI: >90 CRI  
 Lamp Life (hrs): 50000  
 Upon Request: \*\*\*3500K available in minimum quantities (larger quantities upon request)

#### OPTICAL

Optic°: [24 / 32 / 34 / 55 / 58](#)

#### RATINGS AND CERTIFICATIONS

Certified By: Certified for North American Standards  
 IP rating: IP20

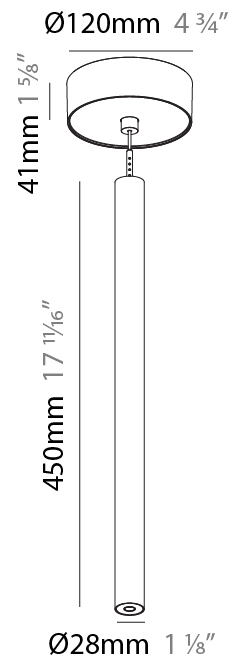

## HANGOVER PLUG MONOPOINT SURFACE CANOPY SUSPENSION

A30846-

PROJECT
TYPE
SPECIFIER
QUANTITY
DATE

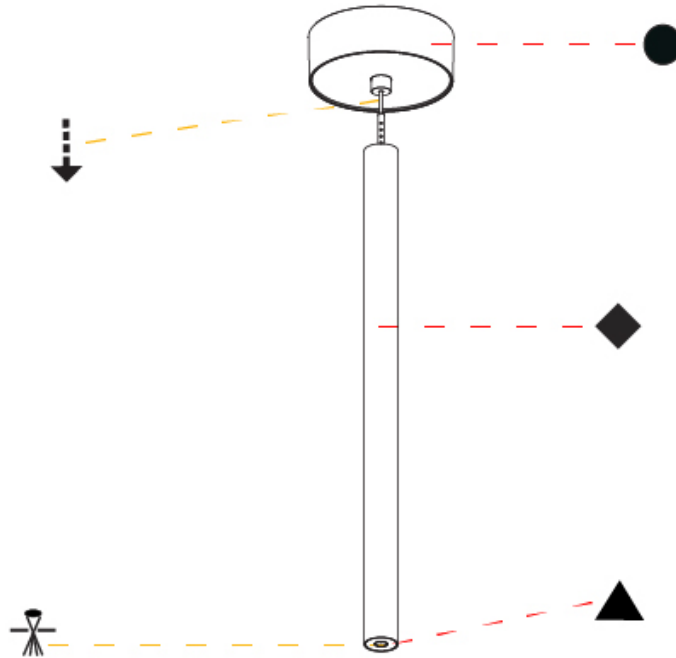

A

PROJECT
TYPE
SPECIFIER
QUANTITY
DATE

## HANGOVER PLUG SHINE MONOPOINT SURFACE CANOPY SUSPENSION

### A30849-

base number	Color Temperature	Finishes (Diamond)	Finishes (Triangle)	Finishes (Circle)	Lens Options	Shine Ring	Cable Options
-------------	-------------------	--------------------	---------------------	-------------------	--------------	------------	---------------

- To build a product code in our configurator select the specify button on the base model # product page
- To build a manual product code on this datasheet choose from the options listed below in blue font and add the suffix to the base model #

#### GENERAL

Series: Hangover  
 Subseries: Hangover Plug Shine Monopoint Surface Canopy  
 Brand: Prolicht  
 Division: Architectural  
 Mounting Type: Suspension  
 Mounting Location: Ceiling  
 Subcategory: Pendant

#### PHYSICAL

Shape: Cylinder  
 Diameter (mm): 28  
 Diameter (in): 1 1/8  
 Height (mm): 450  
 Height (in): 17 11/16  
 Max. Overall Height (mm): 2450  
 Max. Overall Height (in): 96 7/16  
 Light Distribution: Downlight  
 Weight (kg): 0.64  
 Weight (lbs): 1.41  
 Diffuser: Shine Ring - Opal / Yellow / Orange / Red / Blue / Green  
 Fixture Finish: SSR / BKV / CWI / CRY / HAB / UFT / ITA / RUA / FTG / MYG / LOD / PUS / FRO / FUP / KIA / POP / BLS / SPG / MEY / GOH / GUM / CHC / COM / ABZ / JAG / OBR / MOS / ROR  
 Fixture Material: Aluminum  
 Cable Details: 2000mm or 4000mm Black Cable

#### ELECTRICAL

Lamp Type: LED (Zhaga Standard)  
 Input Wattage (W): 6.6  
 Total Output Wattage (W): 6  
 Dimming: Tri-Mode (Non-Dimming and Phase Dimming (120Vac only) and 0-10V Dimming)  
 Driver Included: Yes  
 Driver Location: External  
 Driver Type: Constant Current - Universal  
 Driver Class: Class 2  
 Housing: ENCP3 w/quick connect  
 Input Voltage (V): 120 - 277  
 Constant Current (MA): 500

#### LED

Number of LEDs: 1  
 Color Temperature (°K): 2700 / 3000 / 3500 / 4000  
 Max. Delivered Lumen (lm): 330 / 350 / 363 / 370  
 CRI: >90 CRI  
 Efficiency (%): 86  
 Lamp Life (hrs): 50000  
 Upon Request: \*\*\*3500K available in minimum quantities (larger quantities upon request)

#### OPTICAL

Optic°: 24 / 32 / 58

#### RATINGS AND CERTIFICATIONS

Certified By: Certified for North American Standards  
 IP rating: IP20

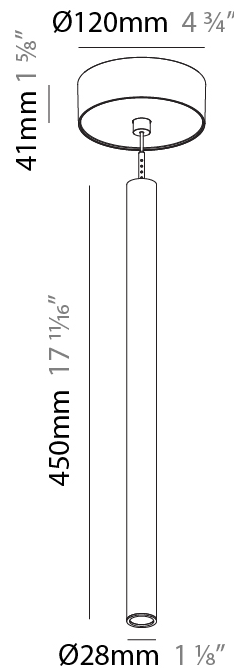

## HANGOVER PLUG SHINE MONOPOINT SURFACE CANOPY SUSPENSION

A30849-

PROJECT
TYPE
SPECIFIER
QUANTITY
DATE

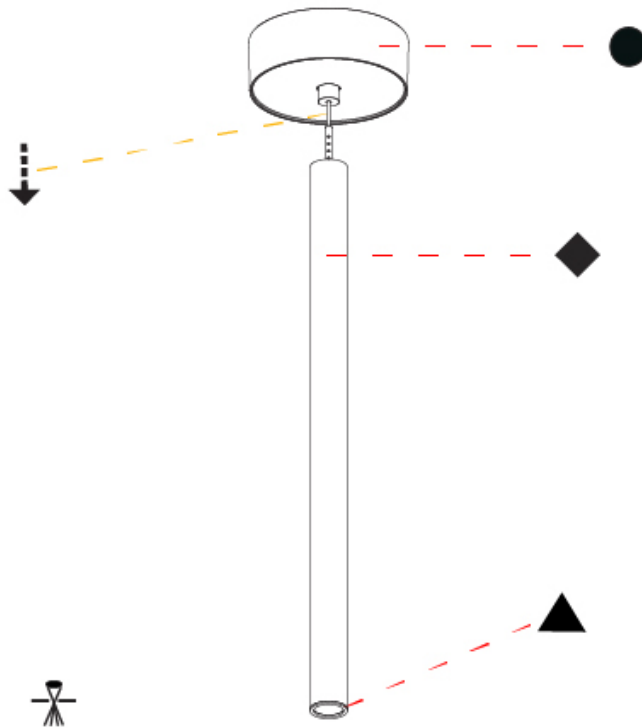

A



## HANGOVER

### COLOR FINISH CHART

PROJECT \_\_\_\_\_

TYPE \_\_\_\_\_

SPECIFIER \_\_\_\_\_

QUANTITY \_\_\_\_\_

DATE \_\_\_\_\_

#### Fixture Finish

Sparkling Silver - 01 (SSR)



Black Velvet - 02 (BKV)



Crystal White - 03 (CWI)



Creamy - 04 (CRY)



Hampton Bay - 05 (HAB)



Urban Forest - 07 (UFT)



In the Army - 08 (ITA)

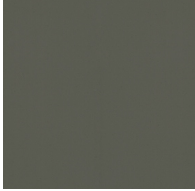

Rusty Angel - 09 (RUA)



Fade to Gray - 12 (FTG)



Mysterious Gray - 13 (MYG)

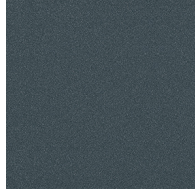

Lost Dream - 15 (LOD)

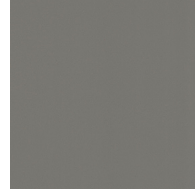

Purple Sky - 16 (PUS)



Fresh Oh - 17 (FRO)

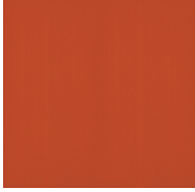

Funky P. - 18 (FUP)



Kissing Aphrodite - 19 (KIA)

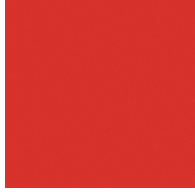

Poseidon's Paradise - 20 (POP)

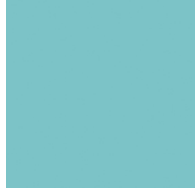

Blue Sky - 21 (BLS)



Spring Green - 22 (SPG)

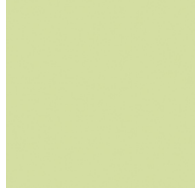

Mellow Yellow - 23 (MEY)

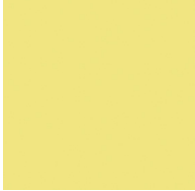

Golden Heart - 24 (GOH)



Gun Metal - 25 (GUM)



Champagne Cream - 26 (CHC)



Copper Mine - 27 (COM)



Ancient Bronze - 28 (ABZ)



Jazz Gold - 29 (JAG)



Olive Breeze - 30 (OBR)



Moonlight Silver - 31 (MOS)



Rosewood Red - 32 (ROR)



## HANGOVER PLUG MONOPOINT SURFACE CANOPY,HANGOVER PLUG SHINE MONOPOINT RECESSED CANOPY,HANGOVER PLUG SHINE MONOPOINT SURFACE CANOPY,HANGOVER PLUG MONOPOINT RECESSED CANOPY **SUSPENSION**

### COLOR FINISH CHART

#### Accent Finish

Yellow - (YEL)

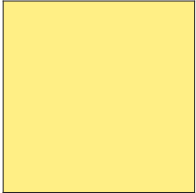

Orange - (ORA)

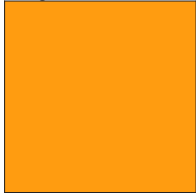

Red - (RED)

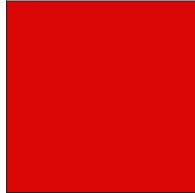

Blue - (BLU)



Green - (GRN)

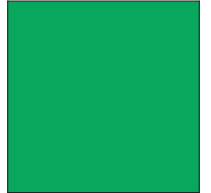

**Digital:** Not all screens are calibrated the same, and therefore, colors will appear differently between screens.

**Physical:** When texture is involved, there will be variations in color, character and tone within a product series and between product families.

**Gun Metal:** No Gun Metal finish is alike. It combines a mixture of transparent and black color particles which ensures a highly individual effect and no luminaire being identical.

**Champagne Cream, Copper Mine, Ancient Bronze + Jazz Gold:** These finishes have slight fading from specific powder coating production. Each luminaire will slightly vary.



### LEGEND

	floor-mounted		pivotal		special LED (upon request) RGB, RGBW, tunable, gold+, meat+, art+, fashion+
	wall and ceiling: recessed and surface mounted		rotating		warm dim / natural dimming LED
	ceiling-mounted and wall-mounted		illuminate tilted		rechargeable battery powered
	wall-mounted		color of suspension cable		fixture with natural vivid LED (upon request)
	omni-directional light distribution		length of suspension cable		color rendering index
	direct light distribution		reflector degree selection		color temperature
	direct/indirect light distribution		super spot		lumen (luminous flux)
	indirect light distribution		lens		efficacy (lumens per watt)
	asymmetric light distribution		lens pack		Unified Glare Rating (UGR) range from 5-40
	aura light distribution		shine ring		marine grade (AISI 316 stainless steel)
	round wall or ceiling cut-out		integrated shine ring with diffuser		walk on
	square wall or ceiling cut-out		free individual colors 01-29		drive on
	the supplied jig specifies the cutout dimensions		individual colors: 00 (free of charge), 01-25 (extra charge)		Dark Sky Compliance
	minimum distance (meters) lamp - object		luminaire part to be colored (F1)		Americans with Disabilities Act (less than 4" off the wall located between 27"-84" from floor)
	recessed depth		luminaire part to be colored (F2)		lamp protected against explosion
	ceiling thickness in mm		luminaire part to be colored (F3)		blown glass using traditional methods by master glass blower
	ceiling thickness selection		luminaire part to be colored (F4)		acoustic material
	dimnable DP (phase), DV (0-10V), DD (dali), DS (step-dim)		luminaire part to be colored (F5)		protection class I, protection insulation
	included or excluded LED driver/transformer/control gear		color of 3-circuit adaptor		protection class II, protection insulation
	separately switchable		indirect diffuser		ETL Certified to UL and CSA Standards
	sensor		direct diffuser		UL Certified to UL and CSA Standards
	remote control		ball-proof (upon request)		CSA Certified to UL and CSA Standards
	available upon request		accessory		Certified for North American Standards

### IP RATING

	protected against ingress of solid bodies greater than 12.5mm (finger)
	protected against ingress of solid bodies greater than 2.5mm protected against sprays of water up to 60 degrees from the vertical (rain)
	protected against ingress of solid bodies greater than 1mm (wire) no protection against the ingress of moisture
	protected against ingress of solid bodies greater than 1mm (wire) protected against sprays of water up to 60 degrees from the vertical (rain)
	protected against ingress of solid bodies greater than 1mm (wire) protected against water splashed from all directions
	protected against limited ingress of dust (wet rooms/covered outdoor areas) protected against water splashed from all directions
	protected against ingress of dust protected against jets of water
	protected against ingress of dust protected against powerful jets of water or heavy seas
	protected against ingress of dust protected against immersion of water between 15cm - 1m for 30 minutes
	protected against ingress of dust protected against immersion of water under pressure for long periods

### IK RATING

	protected against 0.14 joules impact (equivalent to 0.25kg mass dropped from 56mm above the surface)
	protected against 0.2 joules impact (equivalent to 0.25kg mass dropped from 80mm above the surface)
	protected against 0.35 joules impact (equivalent to 0.25kg mass dropped from 140mm above the surface)
	protected against 0.5 joules impact (equivalent to 0.25kg mass dropped from 200mm above the surface)
	protected against 0.7 joules impact (equivalent to 0.25kg mass dropped from 280mm above the surface)
	protected against 1 joules impact (equivalent to 0.25kg mass dropped from 400mm above the surface)
	protected against 2 joules impact (equivalent to 0.5kg mass dropped from 400mm above the surface)
	protected against 5 joules impact (equivalent to 1.7kg mass dropped from 300mm above the surface)
	protected against 10 joules impact (equivalent to 5.0kg mass dropped from 200mm above the surface)
	protected against 20 joules impact (equivalent to 5.0kg mass dropped from 400mm above the surface)