

## HANGOVER PLUG MONOPOINT RECESSED CANOPY SUSPENSION

### A30840-

base number    Color Temperature    Finishes (Diamond)    Finishes (Triangle)    Finishes (Circle)    Lens Options    Cable Options

- To build a product code in our configurator select the specify button on the base model # product page
- To build a manual product code on this datasheet choose from the options listed below in blue font and add the suffix to the base model #

#### GENERAL

Series: Hangover  
 Subseries: Hangover Plug Monopoint Recessed Canopy  
 Brand: Prolicht  
 Division: Architectural  
 Mounting Type: Suspension  
 Mounting Location: Ceiling  
 Subcategory: Pendant

#### PHYSICAL

Shape: Cylinder  
 Diameter (mm): 28  
 Diameter (in): 1 1/8  
 Height (mm): 300  
 Height (in): 11 13/16  
 Max. Overall Height (mm): 2300  
 Max. Overall Height (in): 90 3/16  
 Min. Recessing Depth (mm): 75  
 Min. Recessing Depth (in): 2 15/16  
 Light Distribution: Downlight  
 Weight (kg): 0.389  
 Weight (lbs): 0.856  
 Fixture Finish: SSR / BKV / CWI / CRY / HAB / UFT / ITA / RUA / FTG / MYG / LOD / PUS / FRO / FUP / KIA / POP / BLS / SPG / MEY / GOH / GUM / CHC / COM / ABZ / JAG / OBR / MOS / ROR  
 Fixture Material: Aluminum  
 Cable Details: 2000mm or 4000mm Black Cable  
 Cut-out Measurements: 68mm / 2 11/16"

#### ELECTRICAL

Lamp Type: LED (Zhaga Standard)  
 Input Wattage (W): 6.6  
 Total Output Wattage (W): 6  
 Dimming: Tri-Mode (Non-Dimming and Phase Dimming (120Vac only) and 0-10V Dimming)  
 Driver Included: Yes  
 Driver Location: External  
 Driver Type: Constant Current - Universal  
 Driver Class: Class 2  
 Housing: ENCP3 w/Quick Connect  
 Input Voltage (V): 120 - 277  
 Constant Current (MA): 500

#### LED

Number of LEDs: 1  
 Color Temperature (°K): 2700 / 3000 / 4000  
 Max. Delivered Lumen (lm): 330 / 360 / 380  
 CRI: >90 CRI  
 Lamp Life (hrs): 50000  
 Upon Request: \*\*\*3500K available in minimum quantities (larger quantities upon request)

#### OPTICAL

Optic°: 24 / 32 / 34 / 55 / 58

#### RATINGS AND CERTIFICATIONS

Certified By: Certified for North American Standards  
 IP rating: IP20

Zaneen Group Inc. © 2024, T 1800-388-3382, F 416-247-9319, www.zaneen.com

Available for International specifications by adding 'INT' at the end of the existing Model #. For assistance on 'custom' specifications, contact zteam@zaneen.com. In a constant effort to supply the best product, we reserve the right to change specifications or materials without notice. The most recent specification sheets are found at zaneen.com

|           |
|-----------|
| PROJECT   |
| TYPE      |
| SPECIFIER |
| QUANTITY  |
| DATE      |

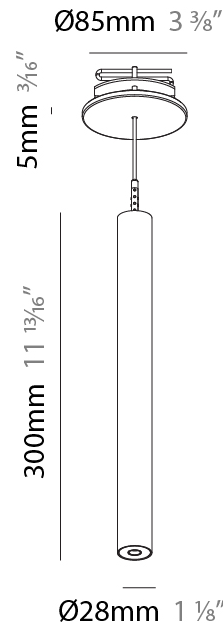

## HANGOVER PLUG MONOPOINT RECESSED CANOPY SUSPENSION

A30840-

PROJECT

TYPE

SPECIFIER

QUANTITY

DATE

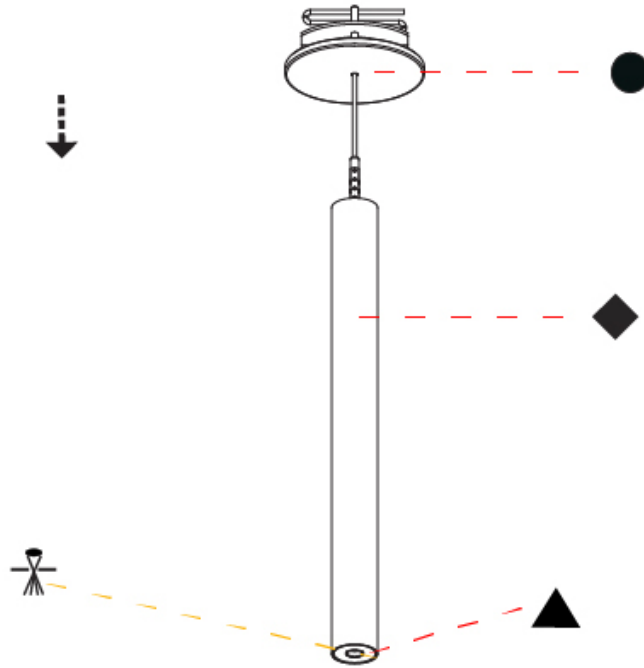

A

|           |
|-----------|
| PROJECT   |
| TYPE      |
| SPECIFIER |
| QUANTITY  |
| DATE      |

## HANGOVER PLUG MONOPOINT RECESSED CANOPY SUSPENSION

### A30841-

|             |                   |                    |                     |                   |              |               |              |
|-------------|-------------------|--------------------|---------------------|-------------------|--------------|---------------|--------------|
| base number | Color Temperature | Finishes (Diamond) | Finishes (Triangle) | Finishes (Circle) | Lens Options | Cable Options | Lens Options |
|-------------|-------------------|--------------------|---------------------|-------------------|--------------|---------------|--------------|

- To build a product code in our configurator select the specify button on the base model # product page
- To build a manual product code on this datasheet choose from the options listed below in blue font and add the suffix to the base model #

#### GENERAL

Series: Hangover  
 Subseries: Hangover Plug Monopoint Recessed Canopy  
 Brand: Prolicht  
 Division: Architectural  
 Mounting Type: Suspension  
 Mounting Location: Ceiling  
 Subcategory: Pendant

#### PHYSICAL

Shape: Cylinder  
 Diameter (mm): 28  
 Diameter (in): 1 1/8  
 Height (mm): 450  
 Height (in): 17 11/16  
 Max. Overall Height (mm): 2450  
 Max. Overall Height (in): 96 7/16  
 Min. Recessing Depth (mm): 75  
 Min. Recessing Depth (in): 2 15/16  
 Light Distribution: Downlight  
 Weight (kg): 0.389  
 Weight (lbs): 0.856  
 Fixture Finish: SSR / BKV / CWI / CRY / HAB / UFT / ITA / RUA / FTG / MYG / LOD / PUS / FRO / FUP / KIA / POP / BLS / SPG / MEY / GOH / GUM / CHC / COM / ABZ / JAG / OBR / MOS / ROR  
 Accent Finish: NOR / OPL / YEL / ORA / RED / BLU / GRN  
 Fixture Material: Aluminum  
 Cable Details: 2000mm or 4000mm Cable - Black, Green, Orange, Red, White  
 Cut-out Measurements: 68mm / 2 11/16"

#### ELECTRICAL

Lamp Type: LED (Zhaga Standard)  
 Input Wattage (W): 6.4  
 Total Output Wattage (W): 6  
 Dimming: Tri-Mode (Non-Dimming and Phase Dimming (120Vac only) and 0-10V Dimming)  
 Driver Included: Yes  
 Driver Location: External  
 Driver Type: Constant Current - Universal  
 Driver Class: Class 2  
 Housing: ENCP3 w/Quick Connect  
 Input Voltage (V): 120 - 277  
 Constant Current (MA): 500

#### LED

Number of LEDs: 1  
 Color Temperature (°K): 2700 / 3000 / 3500 / 4000  
 Max. Delivered Lumen (lm): Max 381 / 404 / 426 / 438  
 Nominal Lumen (lm): 460 / 487 / 514 / 528  
 CRI: >90 CRI  
 Lamp Life (hrs): 50000

#### OPTICAL

Reflector°: 20 / 26 / 56

#### RATINGS AND CERTIFICATIONS

Certified By: CSA Certified to UL and CSA Standards

IP Rating: IP20 © 2024, T 1800-388-3382, F 416-247-9319, www.zaneen.com

Available for International specifications by adding 'INT' at the end of the existing Model #. For assistance on 'custom' specifications, contact zteam@zaneen.com. In a constant effort to supply the best product, we reserve the right to change specifications or materials without notice. The most recent specification sheets are found at zaneen.com

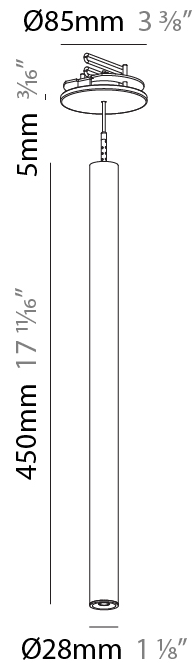

## HANGOVER PLUG MONOPOINT RECESSED CANOPY SUSPENSION

A30841-

PROJECT \_\_\_\_\_

TYPE \_\_\_\_\_

SPECIFIER \_\_\_\_\_

QUANTITY \_\_\_\_\_

DATE \_\_\_\_\_



A

## HANGOVER

### COLOR FINISH CHART

PROJECT \_\_\_\_\_

TYPE \_\_\_\_\_

SPECIFIER \_\_\_\_\_

QUANTITY \_\_\_\_\_

DATE \_\_\_\_\_

#### Fixture Finish

Sparkling Silver - 01 (SSR)



Black Velvet - 02 (BKV)



Crystal White - 03 (CWI)



Creamy - 04 (CRY)



Hampton Bay - 05 (HAB)



Urban Forest - 07 (UFT)



In the Army - 08 (ITA)



Rusty Angel - 09 (RUA)



Fade to Gray - 12 (FTG)



Mysterious Gray - 13 (MYG)



Lost Dream - 15 (LOD)



Purple Sky - 16 (PUS)



Fresh Oh - 17 (FRO)



Funky P. - 18 (FUP)



Kissing Aphrodite - 19 (KIA)



Poseidon's Paradise - 20 (POP)



Blue Sky - 21 (BLS)



Spring Green - 22 (SPG)



Mellow Yellow - 23 (MEY)



Golden Heart - 24 (GOH)



Gun Metal - 25 (GUM)



Champagne Cream - 26 (CHC)



Copper Mine - 27 (COM)



Ancient Bronze - 28 (ABZ)



Jazz Gold - 29 (JAG)



Olive Breeze - 30 (OBR)



Moonlight Silver - 31 (MOS)



Rosewood Red - 32 (ROR)



## HANGOVER PLUG MONOPOINT RECESSED CANOPY SUSPENSION

### COLOR FINISH CHART

#### Accent Finish

Yellow - (YEL)

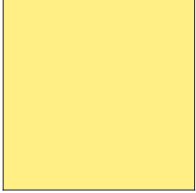

Orange - (ORA)

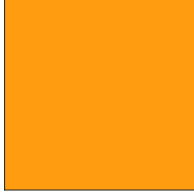

Red - (RED)

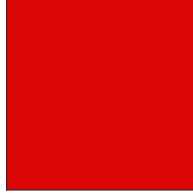

Blue - (BLU)



Green - (GRN)

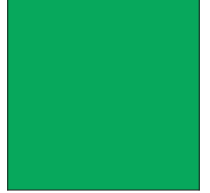

**Digital:** Not all screens are calibrated the same, and therefore, colors will appear differently between screens.

**Physical:** When texture is involved, there will be variations in color, character and tone within a product series and between product families.

**Gun Metal:** No Gun Metal finish is alike. It combines a mixture of transparent and black color particles which ensures a highly individual effect and no luminaire being identical.











**Champagne Cream, Copper Mine, Ancient Bronze + Jazz Gold:** These finishes have slight fading from specific powder coating production. Each luminaire will slightly vary.













### LEGEND

|                                                                                    |                                                           |                                                                                     |                                                              |                                                                                       |                                                                                                |
|------------------------------------------------------------------------------------|-----------------------------------------------------------|-------------------------------------------------------------------------------------|--------------------------------------------------------------|---------------------------------------------------------------------------------------|------------------------------------------------------------------------------------------------|
|    | floor-mounted                                             |    | pivotal                                                      |    | special LED (upon request) RGB, RGBW, tunable, gold+, meat+, art+, fashion+                    |
|    | wall and ceiling: recessed and surface mounted            |    | rotating                                                     |    | warm dim / natural dimming LED                                                                 |
|    | ceiling-mounted and wall-mounted                          |    | illuminate tilted                                            |    | rechargeable battery powered                                                                   |
|    | wall-mounted                                              |    | color of suspension cable                                    |    | fixture with natural vivid LED (upon request)                                                  |
|    | omni-directional light distribution                       |    | length of suspension cable                                   |    | color rendering index                                                                          |
|    | direct light distribution                                 |    | reflector degree selection                                   |    | color temperature                                                                              |
|    | direct/indirect light distribution                        |    | super spot                                                   |    | lumen (luminous flux)                                                                          |
|    | indirect light distribution                               |    | lens                                                         |    | efficacy (lumens per watt)                                                                     |
|    | asymmetric light distribution                             |    | lens pack                                                    |    | Unified Glare Rating (UGR) range from 5-40                                                     |
|    | aura light distribution                                   |    | shine ring                                                   |    | marine grade (AISI 316 stainless steel)                                                        |
|    | round wall or ceiling cut-out                             |    | integrated shine ring with diffuser                          |    | walk on                                                                                        |
|    | square wall or ceiling cut-out                            |    | free individual colors 01-29                                 |    | drive on                                                                                       |
|    | the supplied jig specifies the cutout dimensions          |    | individual colors: 00 (free of charge), 01-25 (extra charge) |    | Dark Sky Compliance                                                                            |
|    | minimum distance (meters) lamp - object                   |    | luminaire part to be colored (F1)                            |    | Americans with Disabilities Act (less than 4" off the wall located between 27"-84" from floor) |
|    | recessed depth                                            |    | luminaire part to be colored (F2)                            |    | lamp protected against explosion                                                               |
|   | ceiling thickness in mm                                   |   | luminaire part to be colored (F3)                            |   | blown glass using traditional methods by master glass blower                                   |
|  | ceiling thickness selection                               |  | luminaire part to be colored (F4)                            |  | acoustic material                                                                              |
|  | dimmable DP (phase), DV (0-10V), DD (dali), DS (step-dim) |  | luminaire part to be colored (F5)                            |  | protection class I, protection insulation                                                      |
|  | included or excluded LED driver/transformer/control gear  |  | color of 3-circuit adaptor                                   |  | protection class II, protection insulation                                                     |
|  | separately switchable                                     |  | indirect diffuser                                            |  | ETL Certified to UL and CSA Standards                                                          |
|  | sensor                                                    |  | direct diffuser                                              |  | UL Certified to UL and CSA Standards                                                           |
|  | remote control                                            |  | ball-proof (upon request)                                    |  | CSA Certified to UL and CSA Standards                                                          |
|  | available upon request                                    |  | accessory                                                    |  | Certified for North American Standards                                                         |

### IP RATING

|                                                                                   |                                                                                                                                                  |
|-----------------------------------------------------------------------------------|--------------------------------------------------------------------------------------------------------------------------------------------------|
|  | protected against ingress of solid bodies greater than 12.5mm (finger)                                                                           |
|  | protected against ingress of solid bodies greater than 2.5mm<br>protected against sprays of water up to 60 degrees from the vertical (rain)      |
|  | protected against ingress of solid bodies greater than 1mm (wire)<br>no protection against the ingress of moisture                               |
|  | protected against ingress of solid bodies greater than 1mm (wire)<br>protected against sprays of water up to 60 degrees from the vertical (rain) |
|  | protected against ingress of solid bodies greater than 1mm (wire)<br>protected against water splashed from all directions                        |
|  | protected against limited ingress of dust (wet rooms/covered outdoor areas)<br>protected against water splashed from all directions              |
|  | protected against ingress of dust<br>protected against jets of water                                                                             |
|  | protected against ingress of dust<br>protected against powerful jets of water or heavy seas                                                      |
|  | protected against ingress of dust<br>protected against immersion of water between 15cm - 1m for 30 minutes                                       |
|  | protected against ingress of dust<br>protected against immersion of water under pressure for long periods                                        |

### IK RATING

|                                                                                     |                                                                                                       |
|-------------------------------------------------------------------------------------|-------------------------------------------------------------------------------------------------------|
|  | protected against 0.14 joules impact (equivalent to 0.25kg mass dropped from 56mm above the surface)  |
|  | protected against 0.2 joules impact (equivalent to 0.25kg mass dropped from 80mm above the surface)   |
|  | protected against 0.35 joules impact (equivalent to 0.25kg mass dropped from 140mm above the surface) |
|  | protected against 0.5 joules impact (equivalent to 0.25kg mass dropped from 200mm above the surface)  |
|  | protected against 0.7 joules impact (equivalent to 0.25kg mass dropped from 280mm above the surface)  |
|  | protected against 1 joules impact (equivalent to 0.25kg mass dropped from 400mm above the surface)    |
|  | protected against 2 joules impact (equivalent to 0.5kg mass dropped from 400mm above the surface)     |
|  | protected against 5 joules impact (equivalent to 1.7kg mass dropped from 300mm above the surface)     |
|  | protected against 10 joules impact (equivalent to 5.0kg mass dropped from 200mm above the surface)    |
|  | protected against 20 joules impact (equivalent to 5.0kg mass dropped from 400mm above the surface)    |