

HAUL SUSPENSION

D91208-

base number Finish
Options

- To build a product code in our configurator select the specify button on the base model # product page
- To build a manual product code on this datasheet choose from the options listed below in blue font and add the suffix to the base model #

GENERAL

Series: Haul
Partner: Milan
Division: Design
Installation: Suspension
Product Type: Pendant
Mounting Location: Ceiling
Light Distribution: Direct

PHYSICAL

Shape: Cylinder
Diameter (mm): 55
Diameter (in): 2 3/16
Height (mm): 210
Height (in): 8 1/4
Max. Overall Height (mm): 2210
Max. Overall Height (in): 87
Fixture Finish: MWL / MBQ
Fixture Material: Extruded Aluminum
Cable Details: 2900mm Cable

ELECTRICAL

Number of Lamps: 1
Lamp Type: LED Retrofit
Max. Wattage Per Lamp (W): 7
Lamp Base: GU10
Input Voltage (V): 120

LED

Number of LEDs: 1
Color Temperature (°K): 3000
Max. Delivered Lumen (lm): 655
CRI: >90 CRI

OPTICAL

RATINGS AND CERTIFICATIONS

Certified By: Certified for North American Standards
IP rating: IP20

PROJECT	_____
TYPE	_____
SPECIFIER	_____
QUANTITY	_____
DATE	_____

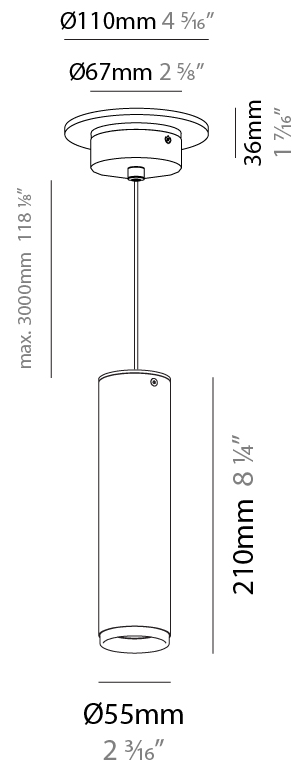

HAUL SUSPENSION

D91208-

PROJECT

TYPE

SPECIFIER

QUANTITY

DATE



D

HAUL SUSPENSION

D91213-

base number Finish
Options

- To build a product code in our configurator select the specify button on the base model # product page
- To build a manual product code on this datasheet choose from the options listed below in blue font and add the suffix to the base model #

GENERAL

Series: Haul
Partner: Milan
Division: Design
Installation: Suspension
Product Type: Pendant
Mounting Location: Ceiling
Light Distribution: Direct

PHYSICAL

Shape: Cylinder
Diameter (mm): 40
Diameter (in): 1 5/16
Height (mm): 153
Height (in): 6
Max. Overall Height (mm): 2153
Max. Overall Height (in): 84 3/4
Fixture Finish: MWL / MBQ
Fixture Material: Extruded Aluminum
Cable Details: 2900mm Cable

ELECTRICAL

Number of Lamps: 1
Lamp Type: LED Retrofit
Max. Wattage Per Lamp (W): 5
Input Voltage (V): 120

LED

Number of LEDs: 1
Color Temperature (°K): 2700
Max. Delivered Lumen (lm): 500
CRI: >90 CRI

OPTICAL

RATINGS AND CERTIFICATIONS

Certified By: Certified for North American Standards
IP rating: IP20

PROJECT	_____
TYPE	_____
SPECIFIER	_____
QUANTITY	_____
DATE	_____

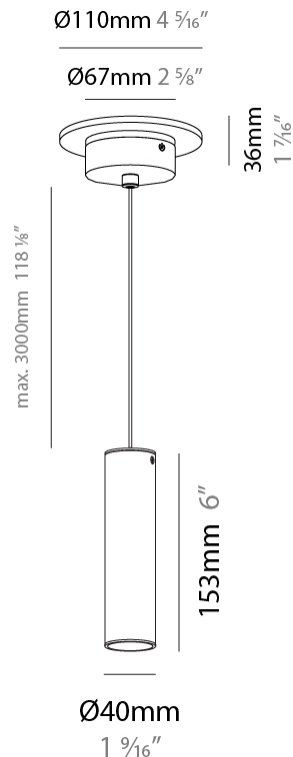

HAUL SUSPENSION

D91213-

PROJECT	_____
TYPE	_____
SPECIFIER	_____
QUANTITY	_____
DATE	_____

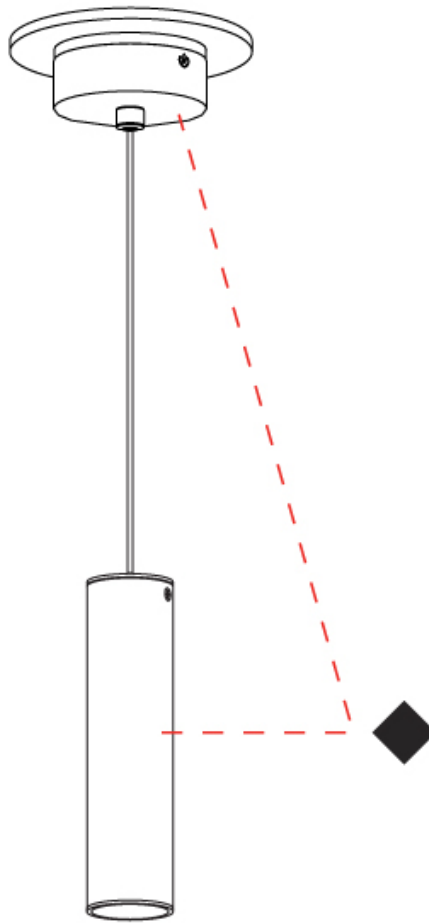

D

PROJECT
TYPE
SPECIFIER
QUANTITY
DATE

HAUL - CEILING SURFACE

D92105R9-

base number Finish
Options

- To build a product code in our configurator select the specify button on the base model # product page
- To build a manual product code on this datasheet choose from the options listed below in blue font and add the suffix to the base model #

GENERAL

Series: Haul
 Subseries: Haul - Ceiling
 Partner: Milan
 Division: Design
 Installation: Surface
 Product Type: Downlight
 Mounting Location: Ceiling
 Light Distribution: Direct

PHYSICAL

Aperture Sizes - Downlights: 1"
 Shape: Cylinder
 Diameter (mm): 40
 Diameter (in): 1 9/16
 Height (mm): 153
 Height (in): 6
 Fixture Finish: MWL / MBQ
 Fixture Material: Extruded Aluminum

ELECTRICAL

Lamp Type: LED
 Input Wattage (W): 5
 Dimming: Electronic Low Voltage Dimming
 Input Voltage (V): 120Vac Direct Line

LED

Number of LEDs: 1
 Color Temperature (°K): 3000
 Max. Delivered Lumen (lm): 500
 CRI: >90 CRI
 Lamp Life (hrs): 50000

OPTICAL

Beam Angle: 35

RATINGS AND CERTIFICATIONS

Certified By: Certified for North American Standards
 IP rating: IP20



Ø40 mm 1 9/16"

153 mm 6"



HAUL - CEILING SURFACE

D92105R9-

PROJECT

TYPE

SPECIFIER

QUANTITY

DATE

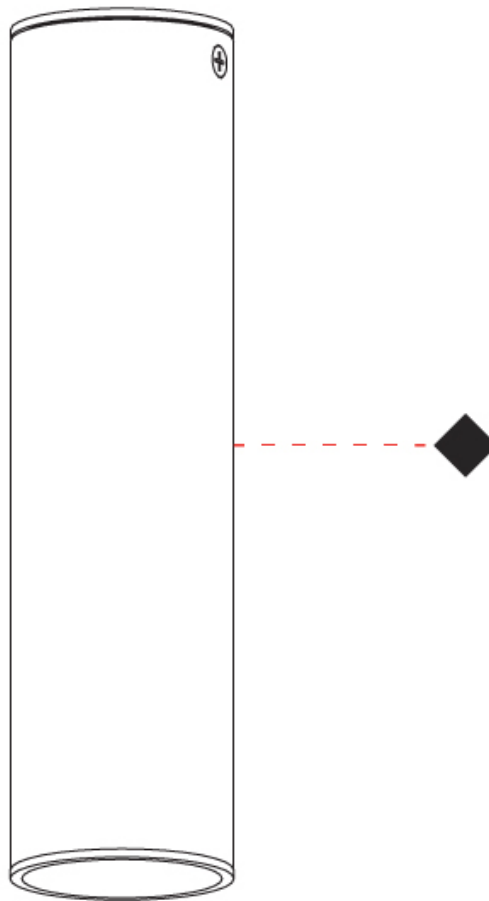

PROJECT
TYPE
SPECIFIER
QUANTITY
DATE

HAUL - CEILING SURFACE

D92105R9- : D92105R9-MBQ

base number

- To build a product code in our configurator select the specify button on the base model # product page
- To build a manual product code on this datasheet choose from the options listed below in blue font and add the suffix to the base model #

GENERAL

Series: Haul
 Subseries: Haul - Ceiling
 Partner: Milan
 Division: Design
 Installation: Surface
 Product Type: Downlight
 Mounting Location: Ceiling
 Light Distribution: Direct

PHYSICAL

Shape: Cylinder
 Diameter (mm): 40
 Diameter (in): 1 9/16
 Height (mm): 153
 Height (in): 6
 Weight (kg): 1.4
 Weight (lbs): 2.999
 Fixture Finish: Matte Black Lacquer
 Fixture Material: Extruded Aluminum

ELECTRICAL

Lamp Type: LED
 Input Wattage (W): 5
 Dimming: Electronic Low Voltage Dimming
 Input Voltage (V): 120Vac Direct Line

LED

Number of LEDs: 1
 Color Temperature (°K): 3000
 Max. Delivered Lumen (lm): 500
 CRI: >90 CRI
 Lamp Life (hrs): 50000

OPTICAL

RATINGS AND CERTIFICATIONS

Certified By: CSA Certified to UL and CSA Standards
 IP rating: IP20

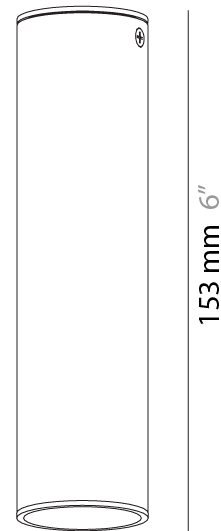

Ø40 mm 1 9/16"

153 mm 6"



HAUL - CEILING SURFACE

D92105R9- : D92105R9-MBQ

PROJECT

TYPE

SPECIFIER

QUANTITY

DATE

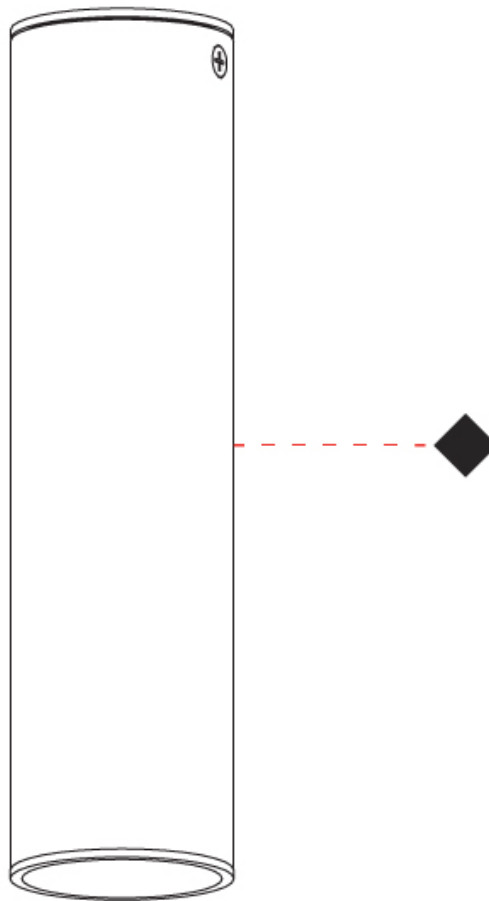

HAUL - CEILING SURFACE

D92248-

base number Finish
Options

- To build a product code in our configurator select the specify button on the base model # product page
- To build a manual product code on this datasheet choose from the options listed below in blue font and add the suffix to the base model #

GENERAL

Series: Haul
Subseries: Haul - Ceiling
Partner: Milan
Division: Design
Installation: Surface
Product Type: Downlight
Mounting Location: Ceiling
Light Distribution: Direct

PHYSICAL

Aperture Sizes - Downlights: 1"
Shape: Cylinder
Diameter (mm): 40
Diameter (in): 1 ⁹/₁₆
Height (mm): 64
Height (in): 2 ¹/₂
[Fixture Finish: MWL / MBQ](#)
Fixture Material: Extruded Aluminum

ELECTRICAL

Lamp Type: LED
Input Wattage (W): 6
Dimming: Non-Dimmable
Driver Included: Yes
Driver Location: External
Input Voltage (V): 120
Constant Current (MA): 200

LED

Number of LEDs: 1
Color Temperature (°K): 3000
Max. Delivered Lumen (lm): 500
CRI: >90 CRI
Lamp Life (hrs): 50000

OPTICAL

Beam Angle: 35

RATINGS AND CERTIFICATIONS

Certified By: Certified for North American Standards
IP rating: IP20

PROJECT	_____
TYPE	_____
SPECIFIER	_____
QUANTITY	_____
DATE	_____

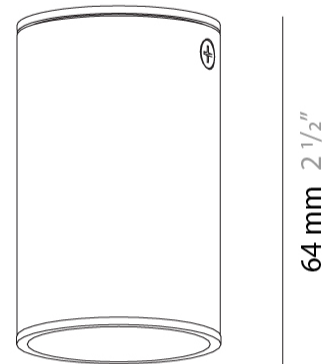

Ø40 mm 1 ⁹/₁₆"



HAUL - CEILING SURFACE

D92248-

PROJECT

TYPE

SPECIFIER

QUANTITY

DATE

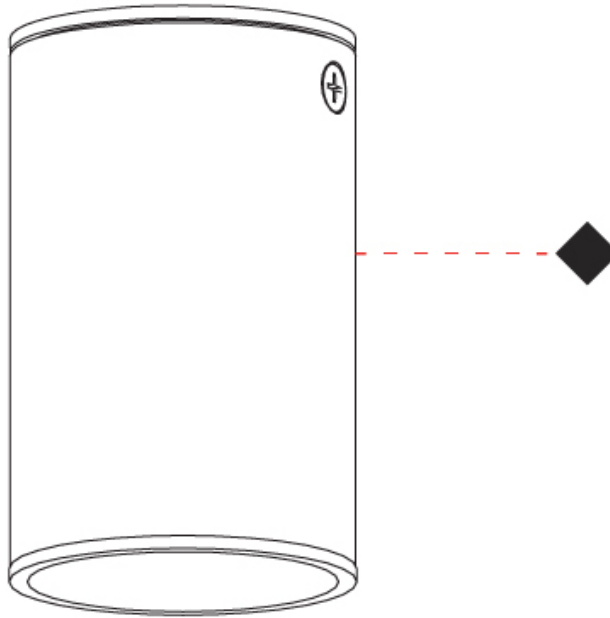

D

PROJECT
TYPE
SPECIFIER
QUANTITY
DATE

HAUL - CEILING SURFACE

D92249-

base number Finish
Options

- To build a product code in our configurator select the specify button on the base model # product page
- To build a manual product code on this datasheet choose from the options listed below in blue font and add the suffix to the base model #

GENERAL

Series: Haul
 Subseries: Haul - Ceiling
 Partner: Milan
 Division: Design
 Installation: Surface
 Product Type: Downlight
 Mounting Location: Ceiling
 Light Distribution: Direct

PHYSICAL

Aperture Sizes - Downlights: 2"
 Shape: Cylinder
 Diameter (mm): 55
 Diameter (in): 2 ³/₁₆
 Height (mm): 93
 Height (in): 3 ¹¹/₁₆
 Fixture Finish: MWL / MBQ
 Fixture Material: Extruded Aluminum

ELECTRICAL

Lamp Type: LED
 Input Wattage (W): 7
 Dimming: Electronic Low Voltage Dimming
 Input Voltage (V): 120Vac Direct Line

LED

Number of LEDs: 1
 Color Temperature (°K): 3000
 Max. Delivered Lumen (lm): 655
 CRI: >90 CRI
 Lamp Life (hrs): 50000

OPTICAL

Beam Angle: 35

RATINGS AND CERTIFICATIONS

Certified By: Certified for North American Standards
 IP rating: IP20

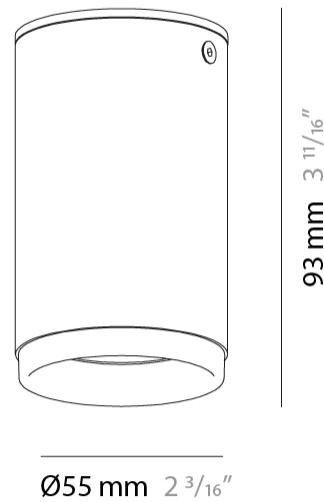

HAUL - CEILING SURFACE

D92249-

PROJECT
TYPE
SPECIFIER
QUANTITY
DATE

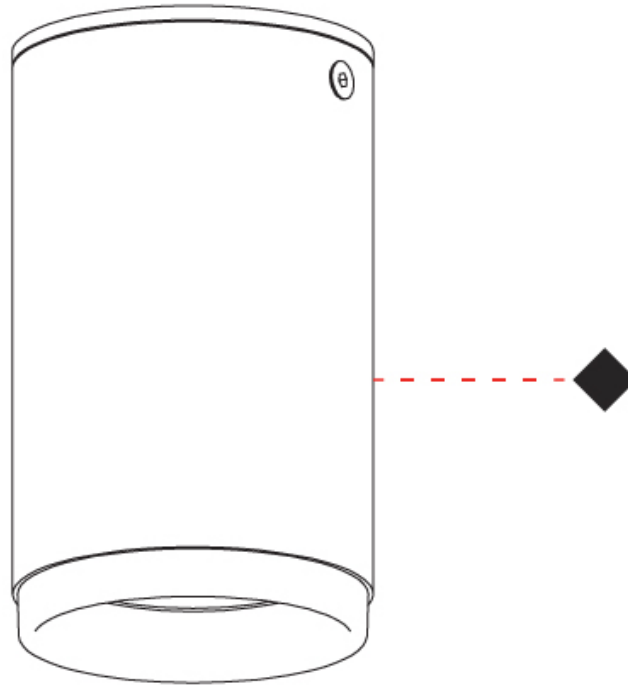

PROJECT
TYPE
SPECIFIER
QUANTITY
DATE

HAUL - CEILING SURFACE

D92250-

base number Finish
Options

- To build a product code in our configurator select the specify button on the base model # product page
- To build a manual product code on this datasheet choose from the options listed below in blue font and add the suffix to the base model #

GENERAL

Series: Haul
 Subseries: Haul - Ceiling
 Partner: Milan
 Division: Design
 Installation: Surface
 Product Type: Downlight
 Mounting Location: Ceiling
 Light Distribution: Direct

PHYSICAL

Aperture Sizes - Downlights: 2"
 Shape: Cylinder
 Diameter (mm): 55
 Diameter (in): 2 ³/₁₆
 Height (mm): 210
 Height (in): 8 ¹/₄
 Fixture Finish: MWL / MBQ
 Fixture Material: Extruded Aluminum

ELECTRICAL

Lamp Type: LED
 Input Wattage (W): 7
 Dimming: Electronic Low Voltage Dimming
 Input Voltage (V): 120Vac Direct Line

LED

Number of LEDs: 1
 Color Temperature (°K): 3000
 Max. Delivered Lumen (lm): 655
 CRI: >90 CRI
 Lamp Life (hrs): 50000

OPTICAL

Beam Angle: 35

RATINGS AND CERTIFICATIONS

Certified By: Certified for North American Standards
 IP rating: IP20

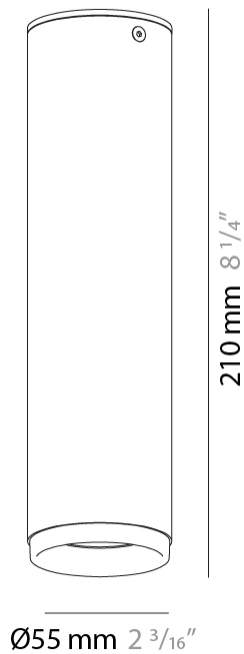

HAUL - CEILING SURFACE

D92250-

PROJECT

TYPE

SPECIFIER

QUANTITY

DATE

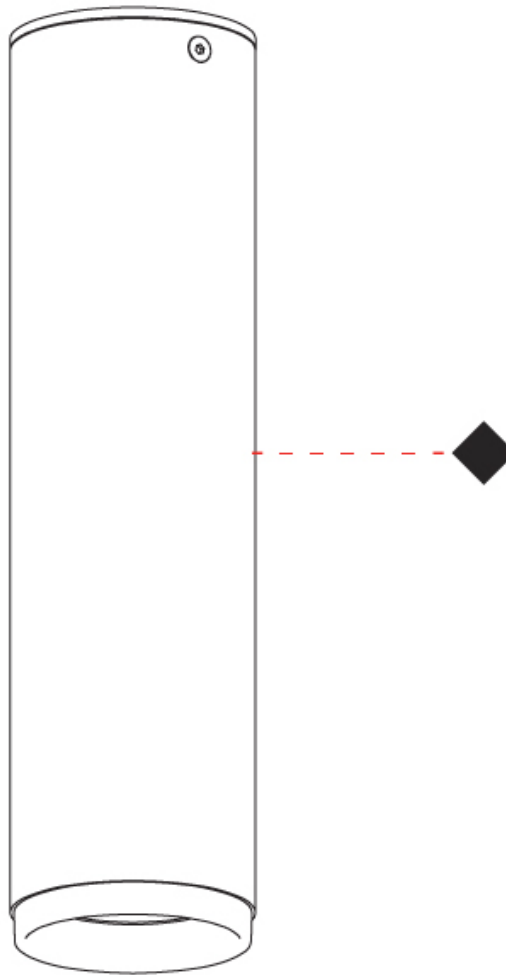

D

PROJECT
TYPE
SPECIFIER
QUANTITY
DATE

HAUL TRACK

D96070-

base number Finish
Options

- To build a product code in our configurator select the specify button on the base model # product page
- To build a manual product code on this datasheet choose from the options listed below in blue font and add the suffix to the base model #

GENERAL

Series: Haul
 Partner: Milan
 Division: Design
 Installation: Track
 Product Type: Track System Line Voltage
 Mounting Location: Ceiling
 Light Distribution: Direct

PHYSICAL

Aperture Sizes - Downlights: 1"
 Shape: Cylinder
 Diameter (mm): 40
 Diameter (in): 1 9/16
 Height (mm): 203
 Height (in): 8
 Max. Overall Height (mm): 1300
 Max. Overall Height (in): 51 7/16
 Fixture Finish: MWL / MBQ
 Fixture Material: Extruded Aluminum

ELECTRICAL

Lamp Type: LED
 Input Wattage (W): 5
 Dimming: Electronic Low Voltage Dimming
 Input Voltage (V): 120Vac Direct Line

LED

Number of LEDs: 1
 Color Temperature (°K): 3000
 Max. Delivered Lumen (lm): 500
 CRI: >90 CRI
 Lamp Life (hrs): 50000

OPTICAL

Reflector°: 35
 Beam Angle: 35

RATINGS AND CERTIFICATIONS

Certified By: Certified for North American Standards
 IP rating: IP20

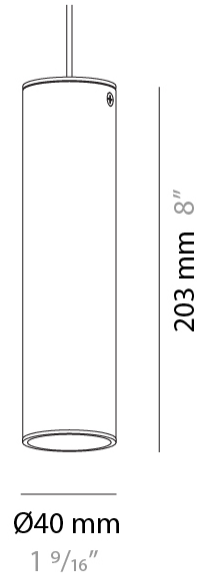

HAUL TRACK

D96070-

PROJECT

TYPE

SPECIFIER

QUANTITY

DATE

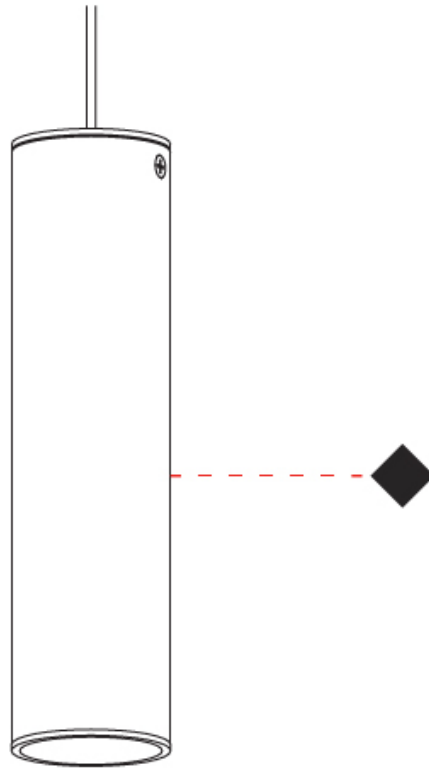

D

HAUL TRACK

D96070- : D96070-MBL

base number

1. To build a product code in our configurator select the specify button on the base model # product page
2. To build a manual product code on this datasheet choose from the options listed below in blue font and add the suffix to the base model #

GENERAL

Series: Haul
Partner: Milan
Division: Design
Installation: Track
Product Type: Track System Line Voltage
Mounting Location: Ceiling
Light Distribution: Direct

PHYSICAL

Shape: Cylinder
Diameter (mm): 40
Height (mm): 203
Max. Overall Height (mm): 1300
Max. Overall Height (in): 51 ³/₁₆
Fixture Material: Extruded Aluminum

ELECTRICAL

Lamp Type: LED
Total Output Wattage (W): 5
Driver Included: No
Input Voltage (V): 120

LED

Color Temperature (°K): 3000
Nominal Lumen (lm): 500
CRI: >90 CRI

OPTICAL

RATINGS AND CERTIFICATIONS

Certified By: Certified for North American Standards
IP rating: IP20

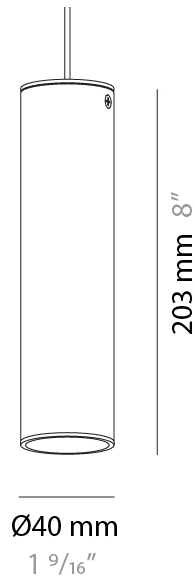

PROJECT
TYPE
SPECIFIER
QUANTITY
DATE

HAUL TRACK

D96071-

base number Finish
Options

- To build a product code in our configurator select the specify button on the base model # product page
- To build a manual product code on this datasheet choose from the options listed below in blue font and add the suffix to the base model #

GENERAL

Series: Haul
 Partner: Milan
 Division: Design
 Installation: Track
 Product Type: Track System Line Voltage
 Mounting Location: Ceiling
 Light Distribution: Direct

PHYSICAL

Aperture Sizes - Downlights: 1"
 Shape: Cylinder
 Diameter (mm): 55
 Diameter (in): 2 ³/₁₆
 Height (mm): 203
 Height (in): 8
 Max. Overall Height (mm): 1300
 Max. Overall Height (in): 51 ⁷/₁₆
 Fixture Finish: MWL / MBQ
 Fixture Material: Extruded Aluminum

ELECTRICAL

Lamp Type: LED
 Input Wattage (W): 7
 Dimming: Electronic Low Voltage Dimming
 Input Voltage (V): 120Vac Direct Line

LED

Number of LEDs: 1
 Color Temperature (°K): 3000
 Max. Delivered Lumen (lm): 665
 CRI: >90 CRI
 Lamp Life (hrs): 50000

OPTICAL

Reflector°: 35
 Beam Angle: 35

RATINGS AND CERTIFICATIONS

Certified By: Certified for North American Standards
 IP rating: IP20



HAUL TRACK

D96071-

PROJECT
TYPE
SPECIFIER
QUANTITY
DATE

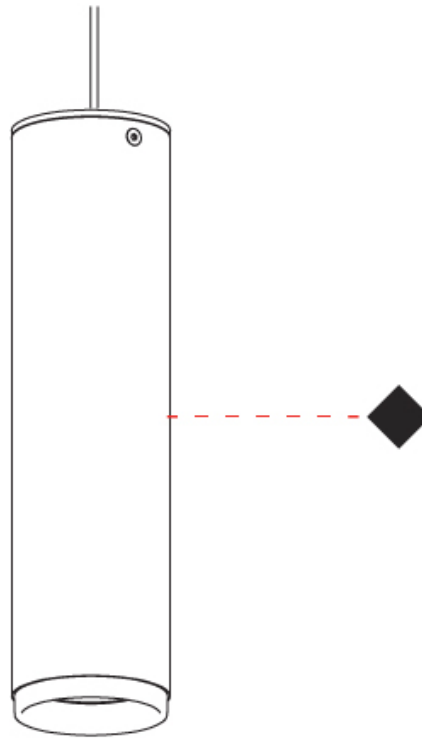

HAUL COLOR FINISH CHART

PROJECT

TYPE

SPECIFIER

QUANTITY

DATE

Fixture Finish

Matte White Lacquer - MWL



Matte Black Lacquer - MBQ

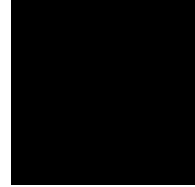

Digital: Not all screens are calibrated the same, and therefore, colors will appear differently between screens.

Physical: When texture is involved, there will be variations in color, character and tone within a product series and between product families.



PROJECT	
TYPE	
SPECIFIER	
QUANTITY	
DATE	

LEGEND

	floor-mounted		pivotable		special LED (upon request) RGB, RGBW, tunable, gold+, meat+, art+, fashion+
	wall and ceiling: recessed and surface mounted		rotating		warm dim / natural dimming LED
	ceiling-mounted and wall-mounted		illuminate tilted		rechargeable battery powered
	wall-mounted		color of suspension cable		fixture with natural vivid LED (upon request)
	omni-directional light distribution		length of suspension cable		color rendering index
	direct light distribution		reflector degree selection		color temperature
	direct/indirect light distribution		super spot		lumen (luminous flux)
	indirect light distribution		lens		efficacy (lumens per watt)
	asymmetric light distribution		lens pack		Unified Glare Rating (UGR) range from 5-40
	aura light distribution		shine ring		marine grade (AISI 316 stainless steel)
	round wall or ceiling cut-out		integrated shine ring with diffuser		walk on
	square wall or ceiling cut-out		free individual colors 01-29		drive on
	the supplied jig specifies the cutout dimensions		individual colors: 00 (free of charge), 01-25 (extra charge)		Dark Sky Compliance
	minimum distance (meters) lamp - object		luminaire part to be colored (F1)		Americans with Disabilities Act (less than 4" off the wall located between 27"-84" from floor)
	recessed depth		luminaire part to be colored (F2)		lamp protected against explosion
	ceiling thickness in mm		luminaire part to be colored (F3)		blown glass using traditional methods by master glass blower
	ceiling thickness selection		luminaire part to be colored (F4)		acoustic material
	dimmable DP (phase), DV (0-10V), DD (dali), DS (step-dim)		luminaire part to be colored (F5)		protection class I, protection insulation
	included or excluded LED driver/transformer/control gear		color of 3-circuit adaptor		protection class II, protection insulation
	separately switchable		indirect diffuser		ETL Certified to UL and CSA Standards
	sensor		direct diffuser		UL Certified to UL and CSA Standards
	remote control		ball-proof (upon request)		CSA Certified to UL and CSA Standards
	available upon request		accessory		Certified for North American Standards

IP RATING

	protected against ingress of solid bodies greater than 12.5mm (finger)
	protected against ingress of solid bodies greater than 2.5mm protected against sprays of water up to 60 degrees from the vertical (rain)
	protected against ingress of solid bodies greater than 1mm (wire) no protection against the ingress of moisture
	protected against ingress of solid bodies greater than 1mm (wire) protected against sprays of water up to 60 degrees from the vertical (rain)
	protected against ingress of solid bodies greater than 1mm (wire) protected against water splashed from all directions
	protected against limited ingress of dust (wet rooms/covered outdoor areas) protected against water splashed from all directions
	protected against ingress of dust protected against jets of water
	protected against ingress of dust protected against powerful jets of water or heavy seas
	protected against ingress of dust protected against immersion of water between 15cm - 1m for 30 minutes
	protected against ingress of dust protected against immersion of water under pressure for long periods

IK RATING

	protected against 0.14 joules impact (equivalent to 0.25kg mass dropped from 56mm above the surface)
	protected against 0.2 joules impact (equivalent to 0.25kg mass dropped from 80mm above the surface)
	protected against 0.35 joules impact (equivalent to 0.25kg mass dropped from 140mm above the surface)
	protected against 0.5 joules impact (equivalent to 0.25kg mass dropped from 200mm above the surface)
	protected against 0.7 joules impact (equivalent to 0.25kg mass dropped from 280mm above the surface)
	protected against 1 joules impact (equivalent to 0.25kg mass dropped from 400mm above the surface)
	protected against 2 joules impact (equivalent to 0.5kg mass dropped from 400mm above the surface)
	protected against 5 joules impact (equivalent to 1.7kg mass dropped from 300mm above the surface)
	protected against 10 joules impact (equivalent to 5.0kg mass dropped from 200mm above the surface)
	protected against 20 joules impact (equivalent to 5.0kg mass dropped from 400mm above the surface)