

PROJECT	_____
TYPE	_____
SPECIFIER	_____
QUANTITY	_____
DATE	_____

HAUL 2 LIGHT SURFACE

D92192R9-

base number _____
 Finish Options _____

- To build a product code in our configurator select the specify button on the base model # product page
- To build a manual product code on this datasheet choose from the options listed below in blue font and add the suffix to the base model #

GENERAL

Series: Haul _____
 Subseries: Haul 2 Light _____
 Brand: Milan _____
 Division: Design _____
 Mounting Type: Surface _____
 Mounting Location: Ceiling _____
 Subcategory: Spots _____

PHYSICAL

Shape: Cylinder _____
 Diameter (mm): 40 _____
 Diameter (in): 1 9/16 _____
 Width (mm): 85 _____
 Width (in): 3 3/8 _____
 Height (mm): 80 _____
 Height (in): 4 7/8 _____
 Light Distribution: Adjustable / Direct _____
 Fixture Finish: MWL / MBQ _____
 Fixture Material: Extruded Aluminum _____

ELECTRICAL

Lamp Type: LED _____
 Input Wattage (W): 10 _____
 Total Output Wattage (W): 8 _____
 Dimming: Electronic Low Voltage Dimming _____
 Input Voltage (V): 120Vac Direct Line _____

LED

Number of LEDs: 2 _____
 Color Temperature (°K): 3000 _____
 Max. Delivered Lumen (lm): 1000 _____
 CRI: >90 CRI _____
 Lamp Life (hrs): 50000 _____

OPTICAL

Beam Angle: 35 _____
 Adjustability: Rotational; Tilt 300° _____

RATINGS AND CERTIFICATIONS

Certified By: Certified for North American Standards _____
 IP rating: IP20 _____

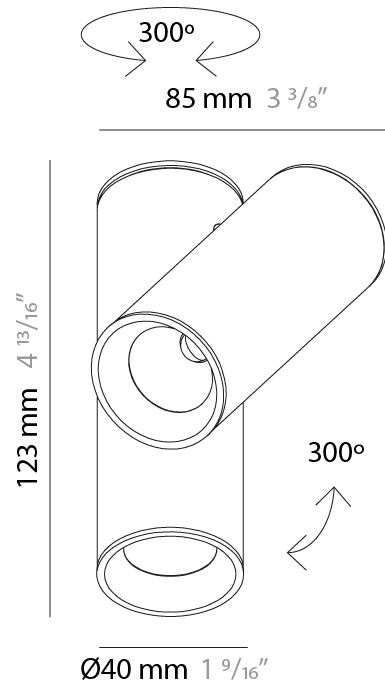

HAUL 2 LIGHT SURFACE

D92192R9-

PROJECT

TYPE

SPECIFIER

QUANTITY

DATE

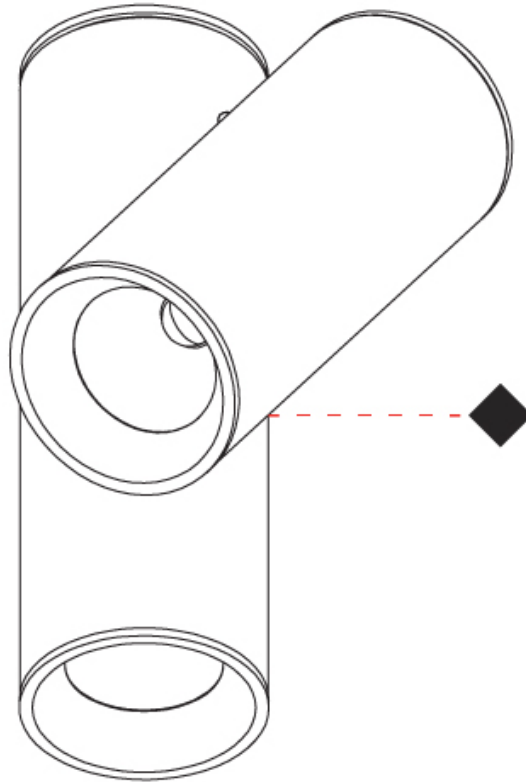

D

HAUL - CEILING SURFACE

D92247-

base number Finish
Options

PROJECT	_____
TYPE	_____
SPECIFIER	_____
QUANTITY	_____
DATE	_____

- To build a product code in our configurator select the specify button on the base model # product page
- To build a manual product code on this datasheet choose from the options listed below in blue font and add the suffix to the base model #

GENERAL

Series: Haul _____
 Subseries: Haul - Ceiling _____
 Brand: Milan _____
 Division: Design _____
 Mounting Type: Surface _____
 Mounting Location: Ceiling _____
 Subcategory: Spots _____

PHYSICAL

Shape: Cylinder _____
 Diameter (mm): 40 _____
 Diameter (in): 1 9/16 _____
 Length (mm): 98 _____
 Length (in): 3 7/8 _____
 Height (mm): 160 _____
 Height (in): 6 5/16 _____
 Light Distribution: Adjustable / Direct _____
 Fixture Finish: MWL / MBQ _____
 Fixture Material: Extruded Aluminum _____

ELECTRICAL

Lamp Type: LED _____
 Input Wattage (W): 5 _____
 Dimming: Electronic Low Voltage Dimming _____
 Input Voltage (V): 120Vac Direct Line _____

LED

Number of LEDs: 1 _____
 Color Temperature (°K): 3000 _____
 Max. Delivered Lumen (lm): 500 _____
 CRI: >90 CRI _____
 Lamp Life (hrs): 50000 _____

OPTICAL

Beam Angle: 35 _____
 Adjustability: Rotational 300°; Tilt 90° _____

RATINGS AND CERTIFICATIONS

Certified By: Certified for North American Standards _____
 IP rating: IP20 _____

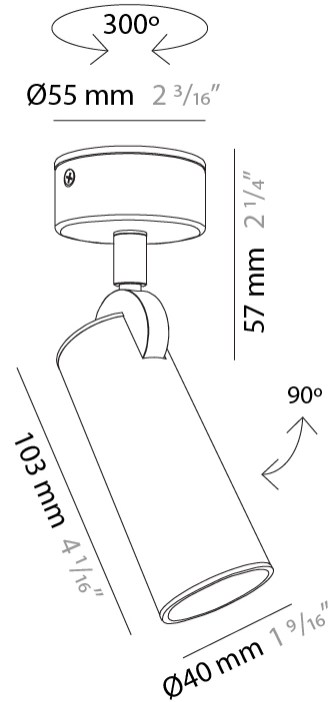

HAUL - CEILING SURFACE

D92247-

PROJECT	_____
TYPE	_____
SPECIFIER	_____
QUANTITY	_____
DATE	_____

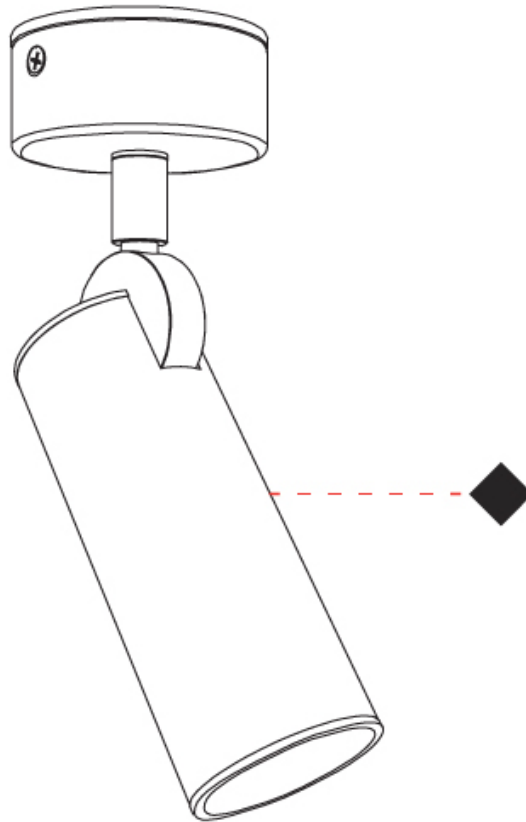

D

PROJECT
TYPE
SPECIFIER
QUANTITY
DATE

HAUL TRACK

D96070-

base number Finish
Options

- To build a product code in our configurator select the specify button on the base model # product page
- To build a manual product code on this datasheet choose from the options listed below in blue font and add the suffix to the base model #

GENERAL

Series: Haul
 Brand: Milan
 Division: Design
 Mounting Type: Track
 Mounting Location: Ceiling
 Subcategory: Spots

PHYSICAL

Shape: Cylinder
 Diameter (mm): 40
 Diameter (in): 1 9/16
 Height (mm): 203
 Height (in): 8
 Max. Overall Height (mm): 1300
 Max. Overall Height (in): 51 3/16
 Light Distribution: Direct
 Fixture Finish: MWL / MBQ
 Fixture Material: Extruded Aluminum

ELECTRICAL

Lamp Type: LED
 Input Wattage (W): 5
 Dimming: Electronic Low Voltage Dimming
 Input Voltage (V): 120Vac Direct Line

LED

Number of LEDs: 1
 Color Temperature (°K): 3000
 Max. Delivered Lumen (lm): 500
 CRI: >90 CRI
 Lamp Life (hrs): 50000

OPTICAL

Reflector°: 35
 Beam Angle: 35

RATINGS AND CERTIFICATIONS

Certified By: Certified for North American Standards
 IP rating: IP20

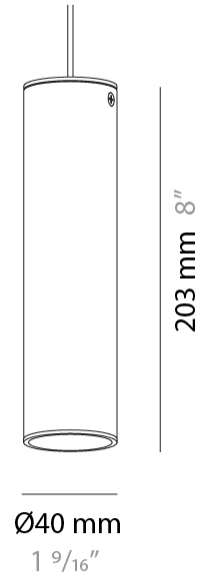

HAUL TRACK

D96070-

PROJECT

TYPE

SPECIFIER

QUANTITY

DATE

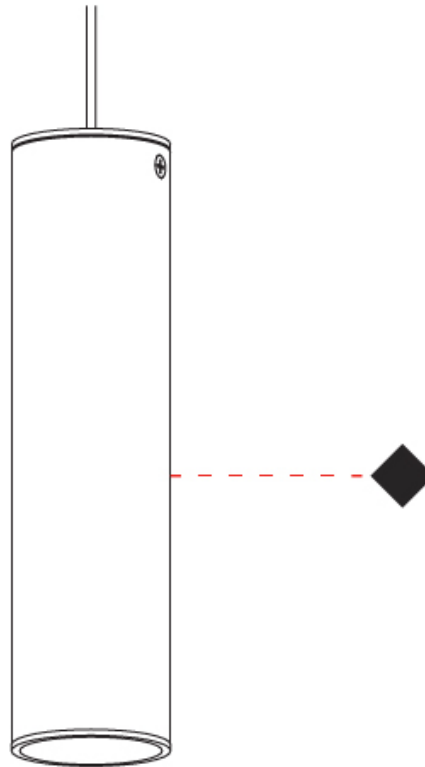

D

HAUL TRACK

D96072-

base number Finish
Options

- To build a product code in our configurator select the specify button on the base model # product page
- To build a manual product code on this datasheet choose from the options listed below in blue font and add the suffix to the base model #

GENERAL

Series: Haul
 Brand: Milan
 Division: Design
 Mounting Type: Track
 Mounting Location: Ceiling
 Subcategory: Spots

PHYSICAL

Shape: Cylinder
 Diameter (mm): 40
 Diameter (in): 1 9/16
 Height (mm): 203
 Height (in): 8
 Max. Overall Height (mm): 1300
 Max. Overall Height (in): 51 3/16
 Light Distribution: Direct
 Fixture Finish: MWL / MBQ
 Fixture Material: Extruded Aluminum

ELECTRICAL

Lamp Type: LED
 Input Wattage (W): 5
 Dimming: Electronic Low Voltage Dimming
 Input Voltage (V): 120Vac Direct Line

LED

Color Temperature (°K): 3000
 Max. Delivered Lumen (lm): 500
 CRI: >90 CRI
 Lamp Life (hrs): 50000

OPTICAL

Reflector°: 35
 Beam Angle: 35

RATINGS AND CERTIFICATIONS

Certified By: Certified for North American Standards
 IP rating: IP20

PROJECT	_____
TYPE	_____
SPECIFIER	_____
QUANTITY	_____
DATE	_____

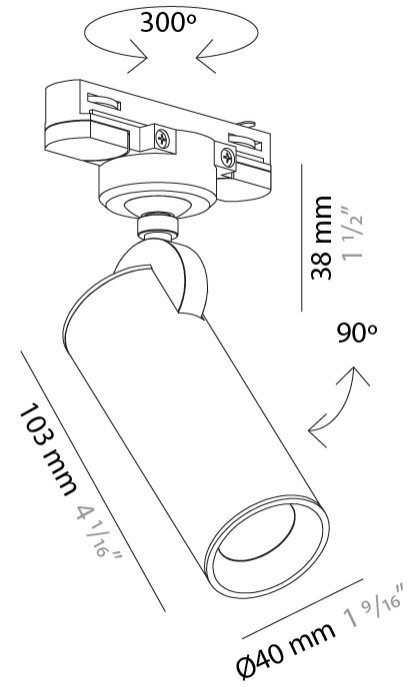

HAUL TRACK

D96072-

PROJECT
TYPE
SPECIFIER
QUANTITY
DATE

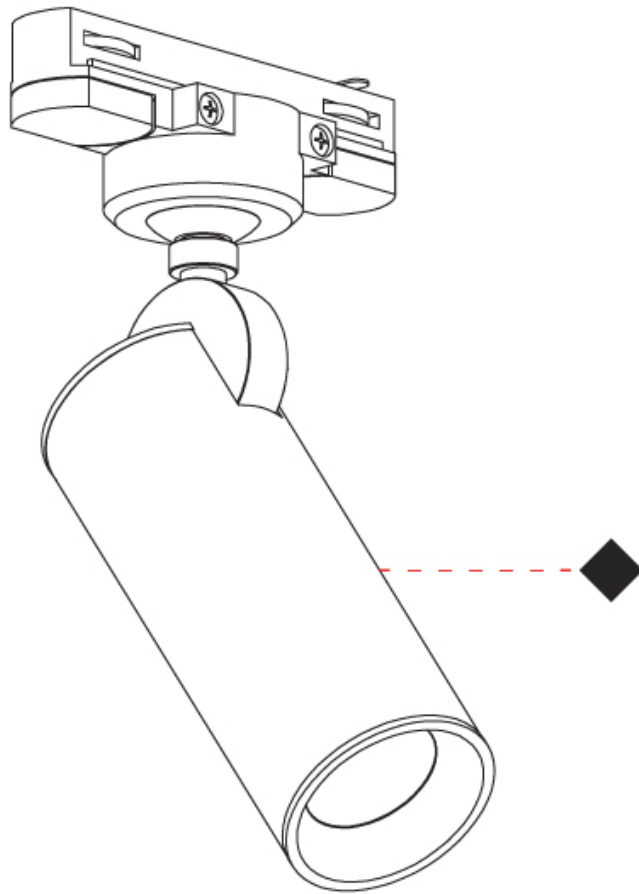

D

HAUL COLOR FINISH CHART

PROJECT

TYPE

SPECIFIER

QUANTITY

DATE

Fixture Finish

Matte White Lacquer - MWL



Matte Black Lacquer - MBQ

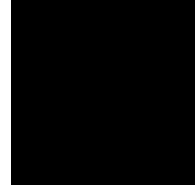





































































Digital: Not all screens are calibrated the same, and therefore, colors will appear differently between screens.

Physical: When texture is involved, there will be variations in color, character and tone within a product series and between product families.













HAUL











LEGEND

	floor-mounted		pivotal		special LED (upon request) RGB, RGBW, tunable, gold+, meat+, art+, fashion+
	wall and ceiling: recessed and surface mounted		rotating		warm dim / natural dimming LED
	ceiling-mounted and wall-mounted		illuminate tilted		rechargeable battery powered
	wall-mounted		color of suspension cable		fixture with natural vivid LED (upon request)
	omni-directional light distribution		length of suspension cable		color rendering index
	direct light distribution		reflector degree selection		color temperature
	direct/indirect light distribution		super spot		lumen (luminous flux)
	indirect light distribution		lens		efficacy (lumens per watt)
	asymmetric light distribution		lens pack		Unified Glare Rating (UGR) range from 5-40
	aura light distribution		shine ring		marine grade (AISI 316 stainless steel)
	round wall or ceiling cut-out		integrated shine ring with diffuser		walk on
	square wall or ceiling cut-out		free individual colors 01-29		drive on
	the supplied jig specifies the cutout dimensions		individual colors: 00 (free of charge), 01-25 (extra charge)		Dark Sky Compliance
	minimum distance (meters) lamp - object		luminaire part to be colored (F1)		Americans with Disabilities Act (less than 4" off the wall located between 27"-84" from floor)
	recessed depth		luminaire part to be colored (F2)		lamp protected against explosion
	ceiling thickness in mm		luminaire part to be colored (F3)		blown glass using traditional methods by master glass blower
	ceiling thickness selection		luminaire part to be colored (F4)		acoustic material
	dimmable DP (phase), DV (0-10V), DD (dali), DS (step-dim)		luminaire part to be colored (F5)		protection class I, protection insulation
	included or excluded LED driver/transformer/control gear		color of 3-circuit adaptor		protection class II, protection insulation
	separately switchable		indirect diffuser		ETL Certified to UL and CSA Standards
	sensor		direct diffuser		UL Certified to UL and CSA Standards
	remote control		ball-proof (upon request)		CSA Certified to UL and CSA Standards
	available upon request		accessory		Certified for North American Standards

IP RATING

	protected against ingress of solid bodies greater than 12.5mm (finger)
	protected against ingress of solid bodies greater than 2.5mm protected against sprays of water up to 60 degrees from the vertical (rain)
	protected against ingress of solid bodies greater than 1mm (wire) no protection against the ingress of moisture
	protected against ingress of solid bodies greater than 1mm (wire) protected against sprays of water up to 60 degrees from the vertical (rain)
	protected against ingress of solid bodies greater than 1mm (wire) protected against water splashed from all directions
	protected against limited ingress of dust (wet rooms/covered outdoor areas) protected against water splashed from all directions
	protected against ingress of dust protected against jets of water
	protected against ingress of dust protected against powerful jets of water or heavy seas
	protected against ingress of dust protected against immersion of water between 15cm - 1m for 30 minutes
	protected against ingress of dust protected against immersion of water under pressure for long periods

IK RATING

	protected against 0.14 joules impact (equivalent to 0.25kg mass dropped from 56mm above the surface)
	protected against 0.2 joules impact (equivalent to 0.25kg mass dropped from 80mm above the surface)
	protected against 0.35 joules impact (equivalent to 0.25kg mass dropped from 140mm above the surface)
	protected against 0.5 joules impact (equivalent to 0.25kg mass dropped from 200mm above the surface)
	protected against 0.7 joules impact (equivalent to 0.25kg mass dropped from 280mm above the surface)
	protected against 1 joules impact (equivalent to 0.25kg mass dropped from 400mm above the surface)
	protected against 2 joules impact (equivalent to 0.5kg mass dropped from 400mm above the surface)
	protected against 5 joules impact (equivalent to 1.7kg mass dropped from 300mm above the surface)
	protected against 10 joules impact (equivalent to 5.0kg mass dropped from 200mm above the surface)
	protected against 20 joules impact (equivalent to 5.0kg mass dropped from 400mm above the surface)