

PROJECT	_____
TYPE	_____
SPECIFIER	_____
QUANTITY	_____
DATE	_____

HELIOS SHELL SUSPENSION

D61030-

base number Finish
Options

- To build a product code in our configurator select the specify button on the base model # product page
- To build a manual product code on this datasheet choose from the options listed below in blue font and add the suffix to the base model #

GENERAL

Series: Helios
 Subseries: Helios Shell
 Partner: Linea Zero
 Division: Design
 Installation: Suspension
 Product Type: Pendant
 Mounting Location: Ceiling

PHYSICAL

Shape: Abstract
 Diameter (mm): 400
 Diameter (in): 15 3/4
 Height (mm): 390
 Height (in): 15 3/8
 Max. Overall Height (mm): 1190
 Max. Overall Height (in): 46 7/8
 Diffuser: Polilux™ Shade - See Finish Options
 Fixture Finish: WHI / BLK / PBL / POR / PGN / COP / NGD / PKM / SIL
 Fixture Material: Polilux™/ Metal holder
 Primary Material: Non-Static Polilux
 Cable Details: Cable length 31"

ELECTRICAL

Number of Lamps: 1
 Lamp Type: LED Retrofit
 Bulb Included: Bulb Not Included
 Max. Wattage Per Lamp (W): 7
 Lamp Base: E26
 Input Voltage (V): 120
 Upon Request: 277Vac / GU24

LED

OPTICAL

RATINGS AND CERTIFICATIONS

Certified By: Certified for North American Standards
 IP rating: IP20

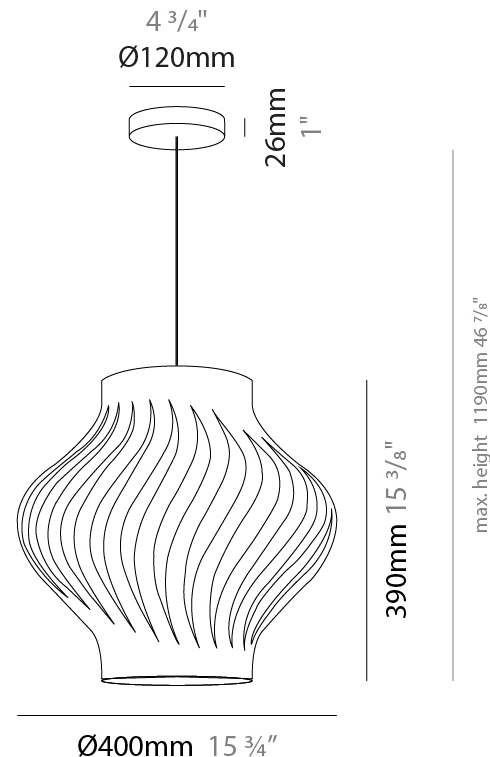

HELIOS SHELL SUSPENSION

D61030-

PROJECT _____

TYPE _____

SPECIFIER _____

QUANTITY _____

DATE _____



PROJECT	
TYPE	
SPECIFIER	
QUANTITY	
DATE	

HELIOS SHELL SUSPENSION

D61030- : D61030-WHI

base number

- To build a product code in our configurator select the specify button on the base model # product page
- To build a manual product code on this datasheet choose from the options listed below in blue font and add the suffix to the base model #

GENERAL

Series: Helios
 Subseries: Helios Shell
 Partner: Linea Zero
 Division: Design
 Installation: Suspension
 Product Type: Pendant
 Mounting Location: Ceiling

PHYSICAL

Shape: Abstract
 Diameter (mm): 400
 Diameter (in): 15 3/4
 Height (mm): 390
 Height (in): 15 3/8
 Max. Overall Height (mm): 1190
 Max. Overall Height (in): 46 7/8
 Weight (kg): 1.5
 Weight (lbs): 1.199
 Diffuser: White - Polilux® Shade
 Fixture Material: Polilux™/ Metal holder
 Primary Material: Non-Static Polilux
 Cable Details: Cable length 31" - White

ELECTRICAL

Number of Lamps: 1
 Lamp Type: LED Retrofit
 Bulb Included: Bulb Not Included
 Total Output Wattage (W): 7
 Max. Wattage Per Lamp (W): 7
 Lamp Base: E26
 Input Voltage (V): 120

LED

OPTICAL

RATINGS AND CERTIFICATIONS

Certified By: CSA Certified to UL and CSA Standards
 IP rating: IP20

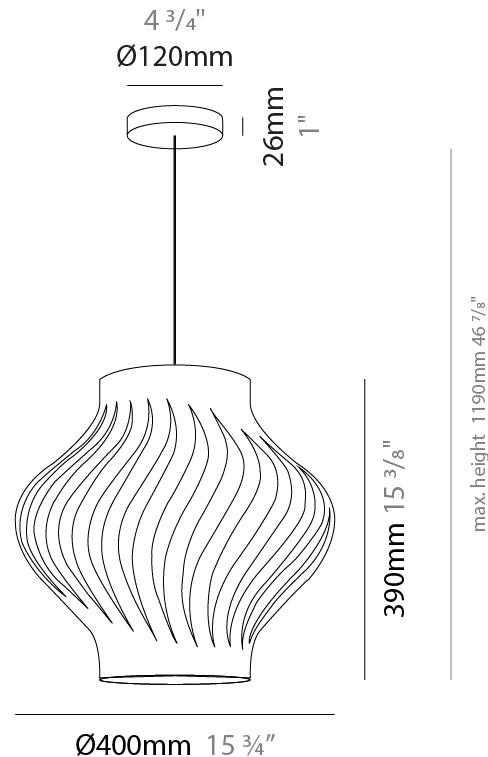

HELIOS SHELL SUSPENSION

D61030- : D61030-WHI

PROJECT

TYPE

SPECIFIER

QUANTITY

DATE



HELIOS LONG SUSPENSION

D61031-

base number Finish
Options

- To build a product code in our configurator select the specify button on the base model # product page
- To build a manual product code on this datasheet choose from the options listed below in blue font and add the suffix to the base model #

GENERAL

Series: Helios
Subseries: Helios Long
Partner: Linea Zero
Division: Design
Installation: Suspension
Product Type: Pendant
Mounting Location: Ceiling
Light Distribution: Downlight

PHYSICAL

Shape: Abstract
Diameter (mm): 350
Diameter (in): 13 3/4
Height (mm): 610
Height (in): 24
Max. Overall Height (mm): 1410
Max. Overall Height (in): 55 1/2
Diffuser: Polilux™ Shade - See Finish Options
Fixture Finish: WHI / BLK / PBL / POR / PGN / COP / NGD / PKM / SIL
Fixture Material: Polilux™/ Metal holder
Primary Material: Non-Static Polilux

ELECTRICAL

Number of Lamps: 1
Lamp Type: LED Retrofit
Bulb Included: Bulb Not Included
Max. Wattage Per Lamp (W): 7
Lamp Base: E26
Input Voltage (V): 120
Upon Request: 277Vac / GU24

LED

OPTICAL

RATINGS AND CERTIFICATIONS

Certified By: Certified for North American Standards
IP rating: IP20

PROJECT	_____
TYPE	_____
SPECIFIER	_____
QUANTITY	_____
DATE	_____

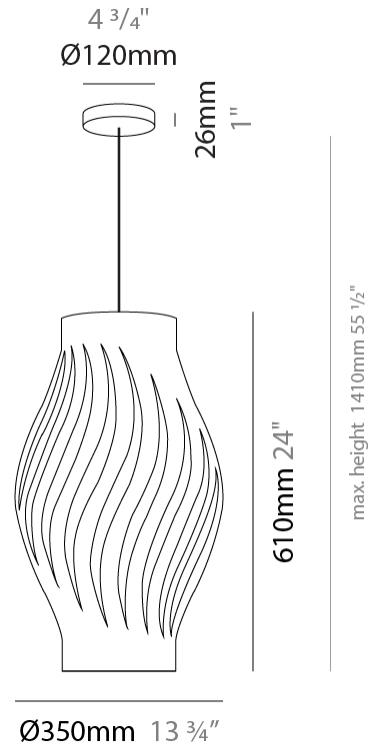

HELIOS LONG SUSPENSION

D61031-

PROJECT

TYPE

SPECIFIER

QUANTITY

DATE

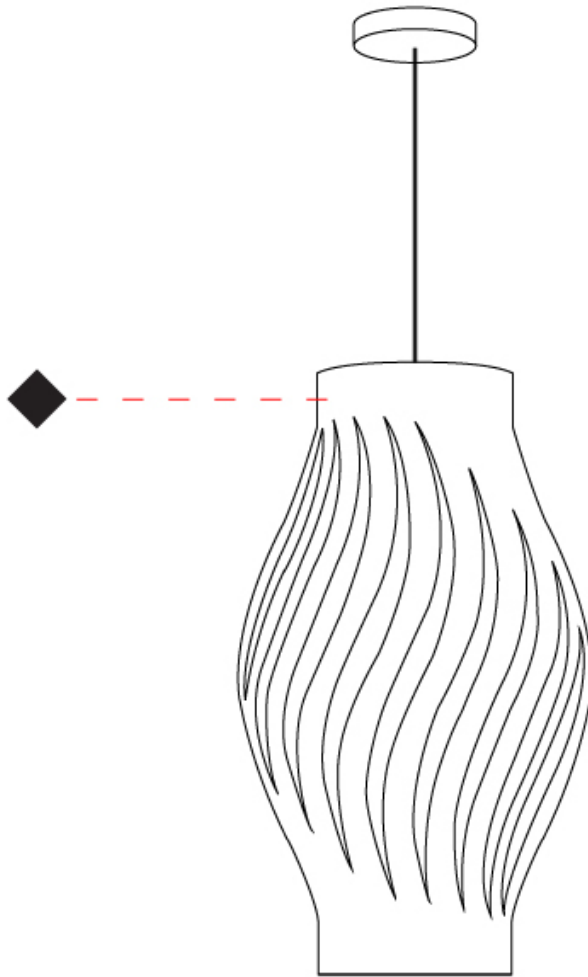

D

PROJECT
TYPE
SPECIFIER
QUANTITY
DATE

HELIOS LONG SUSPENSION

D61033-

base number Finish
Options

- To build a product code in our configurator select the specify button on the base model # product page
- To build a manual product code on this datasheet choose from the options listed below in blue font and add the suffix to the base model #

GENERAL

Series: Helios
 Subseries: Helios Long
 Partner: Linea Zero
 Division: Design
 Installation: Suspension
 Product Type: Pendant
 Mounting Location: Ceiling
 Light Distribution: Downlight

PHYSICAL

Shape: Abstract
 Diameter (mm): 190
 Diameter (in): 7 1/2"
 Height (mm): 320
 Height (in): 12 5/8"
 Max. Overall Height (mm): 1120
 Max. Overall Height (in): 44 1/8"
 Diffuser: Polilux™ Shade - See Finish Options
 Fixture Finish: WHI / BLK / PBL / POR / PGN / COP / NGD / PKM / SIL
 Fixture Material: Polilux™/ Metal holder
 Primary Material: Non-Static Polilux

ELECTRICAL

Number of Lamps: 1
 Lamp Type: LED Retrofit
 Bulb Included: Bulb Not Included
 Max. Wattage Per Lamp (W): 7
 Lamp Base: E26
 Input Voltage (V): 120
 Upon Request: 277Vac / GU24

LED

OPTICAL

RATINGS AND CERTIFICATIONS

Certified By: Certified for North American Standards
 IP rating: IP20

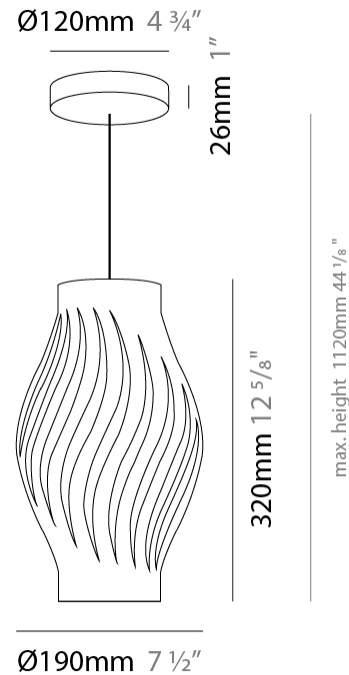

HELIOS LONG SUSPENSION

D61033-

PROJECT

TYPE

SPECIFIER

QUANTITY

DATE

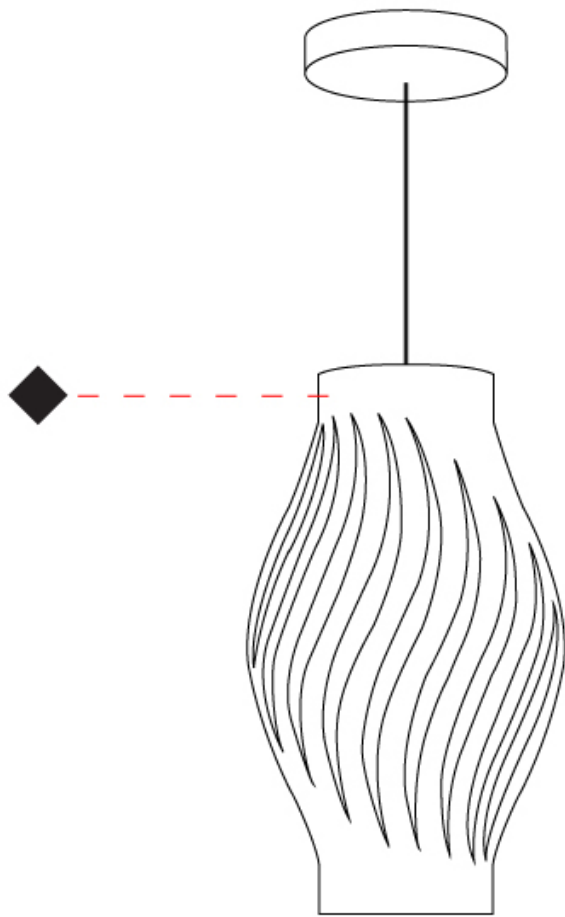

D

PROJECT	_____
TYPE	_____
SPECIFIER	_____
QUANTITY	_____
DATE	_____

HELIOS SURFACE

D62022-

base number Finish
Options

- To build a product code in our configurator select the specify button on the base model # product page
- To build a manual product code on this datasheet choose from the options listed below in blue font and add the suffix to the base model #

GENERAL

Series: Helios _____
 Partner: Linea Zero _____
 Division: Design _____
 Installation: Surface _____
 Product Type: Ceiling Surface _____
 Mounting Location: Ceiling _____

PHYSICAL

Shape: Abstract _____
 Diameter (mm): 400 _____
 Diameter (in): 15 3/4 _____
 Height (mm): 390 _____
 Height (in): 15 3/8 _____
 Diffuser: Polilux™ Shade - See Finish Options _____
 Fixture Finish: WHI / BLK / PBL / POR / PGN / COP / NGD / PKM / SIL _____
 Fixture Material: Polilux™/ Metal holder _____
 Primary Material: Non-Static Polilux _____

ELECTRICAL

Number of Lamps: 1 _____
 Lamp Type: LED Retrofit _____
 Bulb Included: Bulb Not Included _____
 Max. Wattage Per Lamp (W): 7 _____
 Lamp Base: E26 _____
 Input Voltage (V): 120 _____
 Upon Request: 277Vac / GU24 _____

LED

OPTICAL

RATINGS AND CERTIFICATIONS

Certified By: Certified for North American Standards _____
 IP rating: IP20 _____

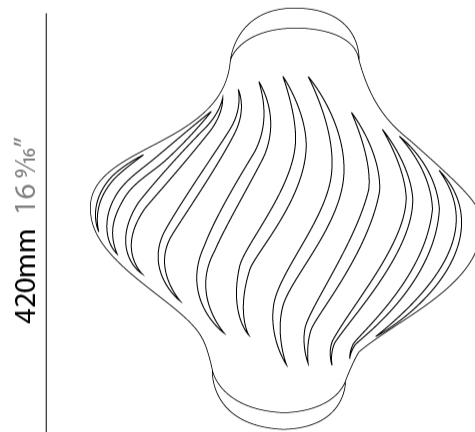

D62022-

PROJECT

TYPE

SPECIFIER

QUANTITY

DATE

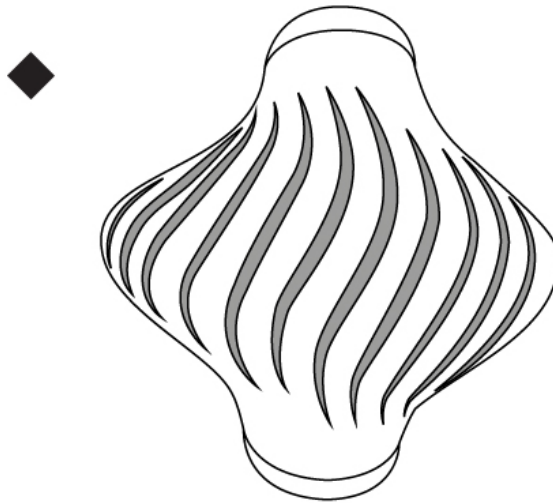

D

PROJECT _____
 TYPE _____
 SPECIFIER _____
 QUANTITY _____
 DATE _____

HELIOS SURFACE

D63004-

base number Finish
 Options

1. To build a product code in our configurator select the specify button on the base model # product page
2. To build a manual product code on this datasheet choose from the options listed below in blue font and add the suffix to the base model #

GENERAL

Series: Helios _____
 Partner: Linea Zero _____
 Division: Design _____
 Installation: Surface _____
 Product Type: Wall Surface _____
 Mounting Location: Wall _____

PHYSICAL

Shape: Abstract _____
 Length (mm): 330 _____
 Length (in): 13 _____
 Height (mm): 250 _____
 Height (in): 9 ¹³/₁₆ _____
 Extension (mm): 170 _____
 Extension (in): 6 ¹¹/₁₆ _____
 Diffuser: Polilux™ Shade - See Finish Options _____
 Fixture Finish: WHI / BLK / PBL / POR / PGN / COP / NGD / PKM / SIL _____
 Fixture Material: Polilux™/ Metal holder _____
 Primary Material: Non-Static Polilux _____

ELECTRICAL

Number of Lamps: 1 _____
 Lamp Type: LED Retrofit _____
 Bulb Included: Bulb Not Included _____
 Max. Wattage Per Lamp (W): 7 _____
 Lamp Base: E26 _____
 Input Voltage (V): 120 _____
 Upon Request: 277Vac / GU24 _____

LED

OPTICAL

RATINGS AND CERTIFICATIONS

Certified By: Certified for North American Standards _____
 IP rating: IP20 _____

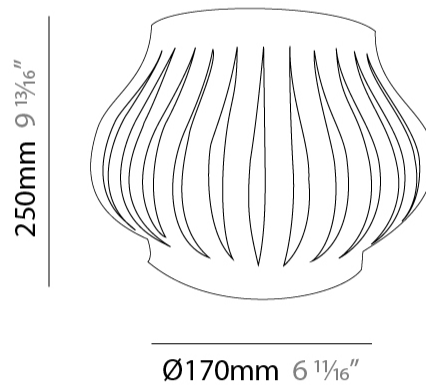

HELIOS SURFACE

D63004-

PROJECT

TYPE

SPECIFIER

QUANTITY

DATE

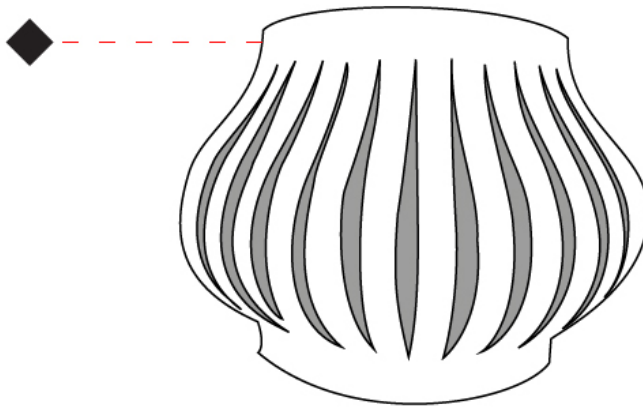

D

PROJECT _____
 TYPE _____
 SPECIFIER _____
 QUANTITY _____
 DATE _____

HELIOS SURFACE

D63005-

base number Finish
 Options

- To build a product code in our configurator select the specify button on the base model # product page
- To build a manual product code on this datasheet choose from the options listed below in blue font and add the suffix to the base model #

GENERAL

Series: Helios _____
 Partner: Linea Zero _____
 Division: Design _____
 Installation: Surface _____
 Product Type: Wall Surface _____
 Mounting Location: Wall _____

PHYSICAL

Shape: Abstract _____
 Length (mm): 330 _____
 Length (in): 13 _____
 Height (mm): 250 _____
 Height (in): 9 ¹³/₁₆ _____
 Extension (mm): 170 _____
 Extension (in): 6 ¹¹/₁₆ _____
 Diffuser: Polilux™ Shade - See Finish Options _____
 Fixture Finish: WHI / BLK / PBL / POR / PGN / COP / NGD / PKM / SIL _____
 Fixture Material: Polilux™/ Metal holder _____
 Primary Material: Non-Static Polilux _____

ELECTRICAL

Number of Lamps: 1 _____
 Lamp Type: LED Retrofit _____
 Bulb Included: Bulb Not Included _____
 Max. Wattage Per Lamp (W): 7 _____
 Lamp Base: E26 _____
 Input Voltage (V): 120 _____
 Upon Request: 277Vac / GU24 _____

LED

OPTICAL

RATINGS AND CERTIFICATIONS

Certified By: Certified for North American Standards _____
 IP rating: IP20 _____

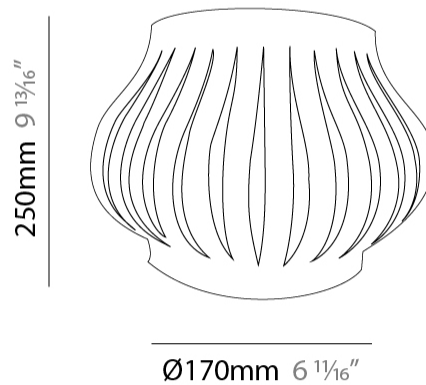

HELIOS SURFACE

D63005-

PROJECT

TYPE

SPECIFIER

QUANTITY

DATE

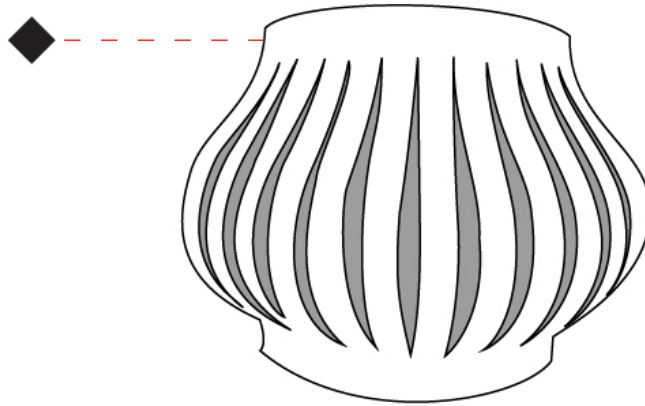

D

PROJECT
TYPE
SPECIFIER
QUANTITY
DATE

HELIOS SURFACE

D63006-

base number Finish
Options

- To build a product code in our configurator select the specify button on the base model # product page
- To build a manual product code on this datasheet choose from the options listed below in blue font and add the suffix to the base model #

GENERAL

Series: Helios
 Partner: Linea Zero
 Division: Design
 Installation: Surface
 Product Type: Wall Surface
 Mounting Location: Wall

PHYSICAL

Shape: Abstract
 Length (mm): 340
 Length (in): 13 ³/₈
 Height (mm): 350
 Height (in): 13 ³/₄
 Extension (mm): 190
 Extension (in): 7 ¹/₂
 Diffuser: Polilux™ Shade - See Finish Options
 Fixture Finish: WHI / BLK / PBL / POR / PGN / COP / NGD / PKM / SIL
 Fixture Material: Polilux™/ Metal holder
 Primary Material: Non-Static Polilux

ELECTRICAL

Number of Lamps: 1
 Lamp Type: LED Retrofit
 Bulb Included: Bulb Not Included
 Max. Wattage Per Lamp (W): 7
 Lamp Base: E26
 Input Voltage (V): 120
 Upon Request: 277Vac / GU24

LED

OPTICAL

RATINGS AND CERTIFICATIONS

Certified By: Certified for North American Standards
 IP rating: IP20



HELIOS SURFACE

D63006-

PROJECT

TYPE

SPECIFIER

QUANTITY

DATE

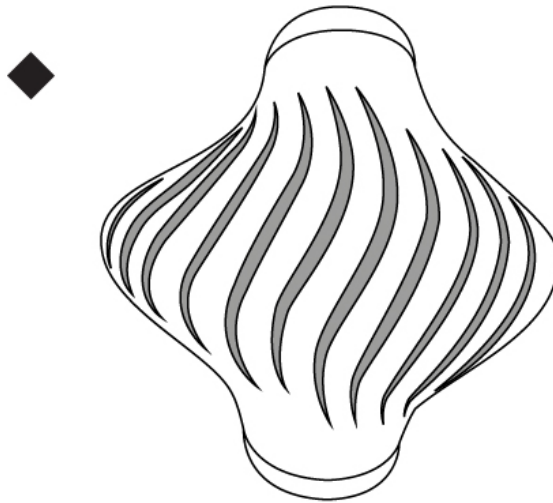

D

PROJECT	_____
TYPE	_____
SPECIFIER	_____
QUANTITY	_____
DATE	_____

HELIOS SURFACE

D63007-

base number Finish
Options

- To build a product code in our configurator select the specify button on the base model # product page
- To build a manual product code on this datasheet choose from the options listed below in blue font and add the suffix to the base model #

GENERAL

Series: Helios _____
 Partner: Linea Zero _____
 Division: Design _____
 Installation: Surface _____
 Product Type: Wall Surface _____
 Mounting Location: Wall _____
 Light Distribution: Direct / Indirect _____

PHYSICAL

Shape: Abstract _____
 Length (mm): 340 _____
 Length (in): 13 ³/₈ _____
 Height (mm): 350 _____
 Height (in): 13 ³/₄ _____
 Extension (mm): 190 _____
 Extension (in): 7 ¹/₂ _____
 Diffuser: Polilux™ Shade - See Finish Options _____
 Fixture Finish: WHI / BLK / PBL / POR / PGN / COP / NGD / PKM / SIL _____
 Fixture Material: Polilux™/ Metal holder _____
 Primary Material: Non-Static Polilux _____

ELECTRICAL

Number of Lamps: 1 _____
 Lamp Type: LED Retrofit _____
 Bulb Included: Bulb Not Included _____
 Max. Wattage Per Lamp (W): 7 _____
 Lamp Base: E26 _____
 Input Voltage (V): 120 _____
 Upon Request: 277Vac / GU24 _____

LED

OPTICAL

RATINGS AND CERTIFICATIONS

Certified By: Certified for North American Standards _____
 IP rating: IP20 _____

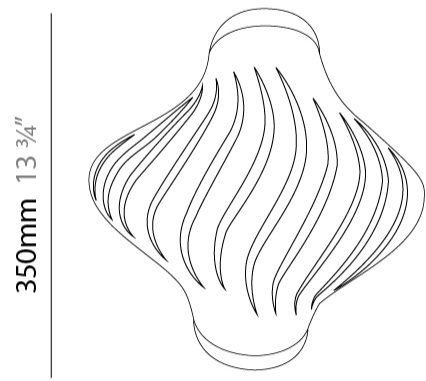

D63007-

PROJECT

TYPE

SPECIFIER

QUANTITY

DATE

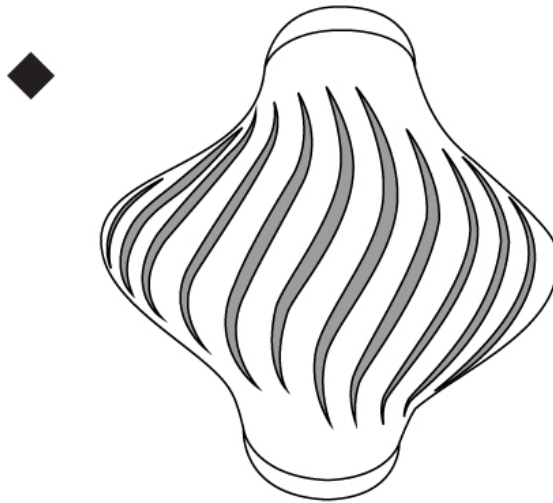

HELIOS SURFACE

D63009-

base number

1. To build a product code in our configurator select the specify button on the base model # product page
2. To build a manual product code on this datasheet choose from the options listed below in blue font and add the suffix to the base model #

GENERAL

Series: Helios
Partner: Linea Zero
Division: Design
Installation: Surface
Product Type: Wall Surface
Mounting Location: Wall

PHYSICAL

Shape: Cylinder
Length (mm): 100
Length (in): 3 ¹⁵/₁₆
Height (mm): 350
Height (in): 13 ³/₄
Extension (mm): 90
Extension (in): 3 ⁹/₁₆
Diffuser: Polilux™ Shade - See Finish Options
Fixture Finish: WHI
Fixture Material: Polilux™/ Metal holder
Primary Material: Non-Static Polilux

ELECTRICAL

Number of Lamps: 1
Lamp Type: LED Retrofit
Bulb Included: Bulb Not Included
Max. Wattage Per Lamp (W): 7
Lamp Base: E26
Input Voltage (V): 120
Upon Request: 277Vac / GU24

LED

OPTICAL

RATINGS AND CERTIFICATIONS

Certified By: Certified for North American Standards
IP rating: IP20

PROJECT	_____
TYPE	_____
SPECIFIER	_____
QUANTITY	_____
DATE	_____

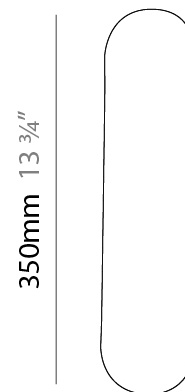

D63009-

PROJECT

TYPE

SPECIFIER

QUANTITY

DATE

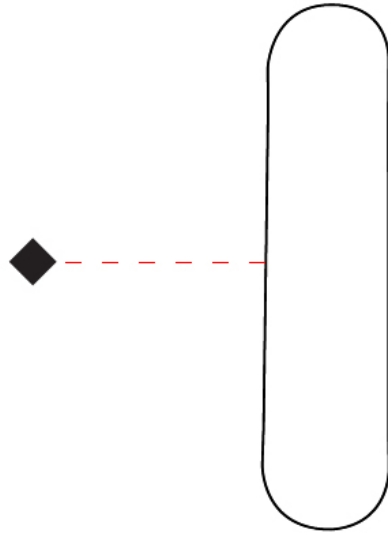

PROJECT	_____
TYPE	_____
SPECIFIER	_____
QUANTITY	_____
DATE	_____

HELIOS PORTABLE

D64023-

base number Finish
Options

- To build a product code in our configurator select the specify button on the base model # product page
- To build a manual product code on this datasheet choose from the options listed below in blue font and add the suffix to the base model #

GENERAL

Series: Helios _____
 Partner: Linea Zero _____
 Division: Design _____
 Installation: Portable _____
 Product Type: Table _____
 Mounting Location: Table _____

PHYSICAL

Shape: Abstract _____
 Diameter (mm): 400 _____
 Diameter (in): 15 3/4 _____
 Height (mm): 390 _____
 Height (in): 15 3/8 _____
 Diffuser: Polilux™ Shade - See Finish Options _____
 Fixture Finish: WHI / BLK / PBL / POR / PGN / COP / NGD / PKM / SIL _____
 Fixture Material: Polilux™/ Metal holder _____
 Primary Material: Non-Static Polilux _____
 Upon Request: Bolt Down _____

ELECTRICAL

Number of Lamps: 1 _____
 Lamp Type: LED Retrofit _____
 Bulb Included: Bulb Not Included _____
 Max. Wattage Per Lamp (W): 7 _____
 Lamp Base: E26 _____
 Input Voltage (V): 120 _____
 Upon Request: 277Vac / GU24 _____

LED

OPTICAL

RATINGS AND CERTIFICATIONS

Certified By: Certified for North American Standards _____
 IP rating: IP20 _____



HELIOS PORTABLE

D64023-

PROJECT

TYPE

SPECIFIER

QUANTITY

DATE

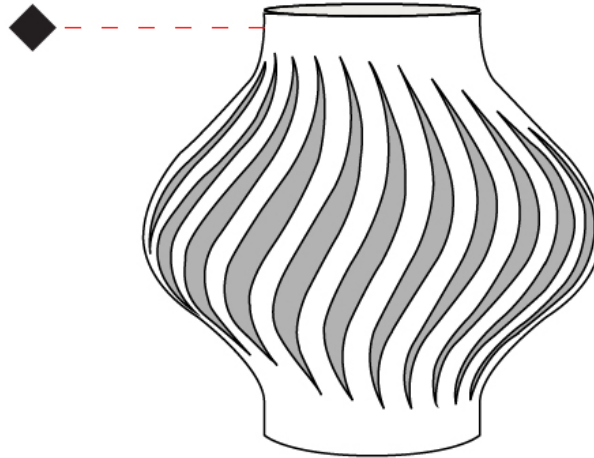

D

PROJECT
TYPE
SPECIFIER
QUANTITY
DATE

HELIOS PORTABLE

D64024-

base number Finish
Options

- To build a product code in our configurator select the specify button on the base model # product page
- To build a manual product code on this datasheet choose from the options listed below in blue font and add the suffix to the base model #

GENERAL

Series: Helios
 Partner: Linea Zero
 Division: Design
 Installation: Portable
 Product Type: Table
 Mounting Location: Table

PHYSICAL

Shape: Abstract
 Diameter (mm): 350
 Diameter (in): 13 3/4
 Height (mm): 610
 Height (in): 24
 Diffuser: Polilux™ Shade - See Finish Options
[Fixture Finish: WHI / BLK / PBL / POR / PGN / COP / NGD / PKM / SIL](#)
 Fixture Material: Polilux™/ Metal holder
 Primary Material: Non-Static Polilux
 Upon Request: Bolt Down

ELECTRICAL

Number of Lamps: 1
 Lamp Type: LED Retrofit
 Bulb Included: Bulb Not Included
 Max. Wattage Per Lamp (W): 7
 Lamp Base: E26
 Input Voltage (V): 120
 Upon Request: 277Vac / GU24

LED

OPTICAL

RATINGS AND CERTIFICATIONS

Certified By: Certified for North American Standards
 IP rating: IP20

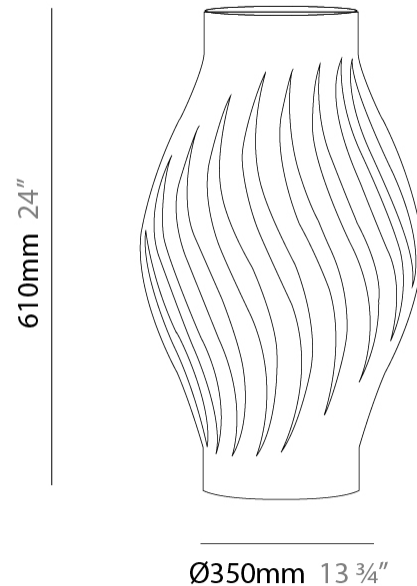

HELIOS PORTABLE

D64024-

PROJECT

TYPE

SPECIFIER

QUANTITY

DATE

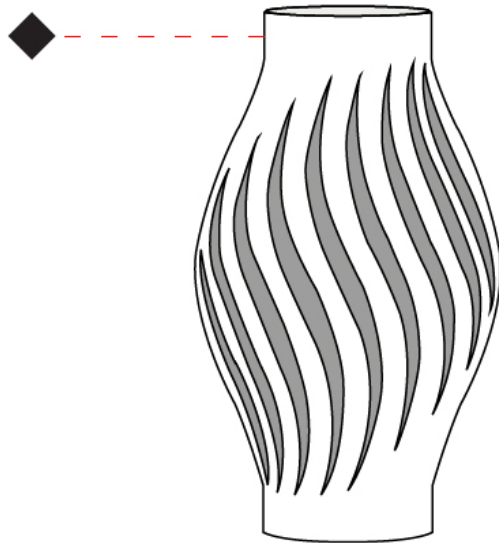

D

PROJECT	_____
TYPE	_____
SPECIFIER	_____
QUANTITY	_____
DATE	_____

HELIOS PORTABLE

D64026-

base number Finish
Options

- To build a product code in our configurator select the specify button on the base model # product page
- To build a manual product code on this datasheet choose from the options listed below in blue font and add the suffix to the base model #

GENERAL

Series: Helios _____
 Partner: Linea Zero _____
 Division: Design _____
 Installation: Portable _____
 Product Type: Table _____
 Mounting Location: Table _____

PHYSICAL

Shape: Abstract _____
 Diameter (mm): 190 _____
 Diameter (in): 7 1/2 _____
 Height (mm): 320 _____
 Height (in): 12 5/8 _____
 Diffuser: Polilux™ Shade - See Finish Options _____
 Fixture Finish: WHI / BLK / PBL / POR / PGN / COP / NGD / PKM / SIL _____
 Fixture Material: Polilux™/ Metal holder _____
 Primary Material: Non-Static Polilux _____
 Upon Request: Bolt Down _____

ELECTRICAL

Number of Lamps: 1 _____
 Lamp Type: LED Retrofit _____
 Bulb Included: Bulb Not Included _____
 Max. Wattage Per Lamp (W): 7 _____
 Lamp Base: E26 _____
 Input Voltage (V): 120 _____
 Upon Request: 277Vac / GU24 _____

LED

OPTICAL

RATINGS AND CERTIFICATIONS

Certified By: Certified for North American Standards _____
 IP rating: IP20 _____

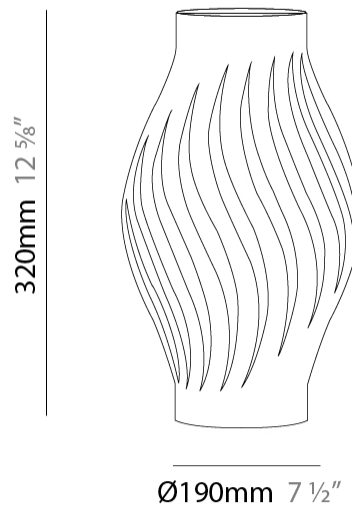

HELIOS PORTABLE

D64026-

PROJECT

TYPE

SPECIFIER

QUANTITY

DATE

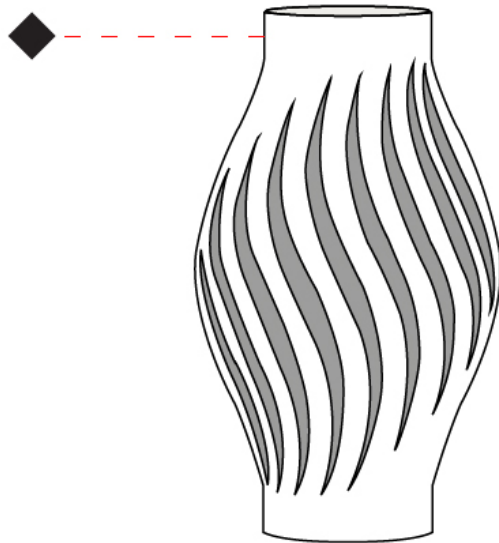

D

PROJECT	_____
TYPE	_____
SPECIFIER	_____
QUANTITY	_____
DATE	_____

HELIOS PORTABLE

D64027-

base number Finish
Options

1. To build a product code in our configurator select the specify button on the base model # product page
2. To build a manual product code on this datasheet choose from the options listed below in blue font and add the suffix to the base model #

GENERAL

Series: Helios _____
 Partner: Linea Zero _____
 Division: Design _____
 Installation: Portable _____
 Product Type: Table _____
 Mounting Location: Table _____

PHYSICAL

Shape: Abstract _____
 Diameter (mm): 130 _____
 Diameter (in): 5 1/8 _____
 Height (mm): 210 _____
 Height (in): 8 1/4 _____
 Diffuser: Polilux™ Shade - See Finish Options _____
 Fixture Finish: WHI / BLK / PBL / POR / PGN / COP / NGD / PKM / SIL _____
 Fixture Material: Polilux™/ Metal holder _____
 Primary Material: Non-Static Polilux _____
 Upon Request: Bolt Down _____

ELECTRICAL

Number of Lamps: 1 _____
 Lamp Type: LED Retrofit _____
 Bulb Included: Bulb Not Included _____
 Max. Wattage Per Lamp (W): 3 _____
 Lamp Base: E12 _____
 Input Voltage (V): 120 _____

LED

OPTICAL

RATINGS AND CERTIFICATIONS

Certified By: Certified for North American Standards _____
 IP rating: IP20 _____

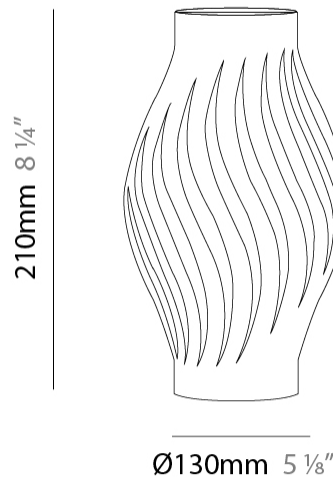

HELIOS PORTABLE

D64027-

PROJECT

TYPE

SPECIFIER

QUANTITY

DATE

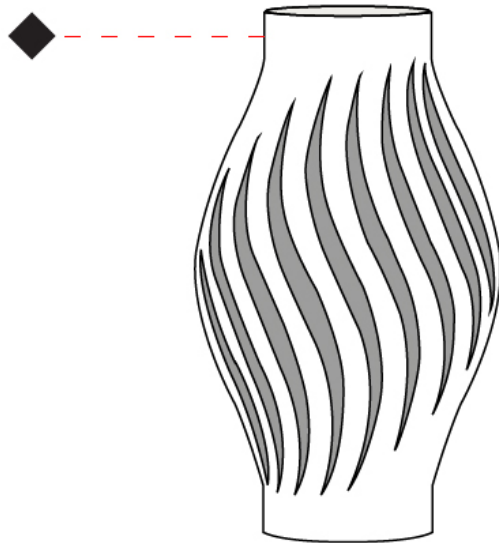

D

HELIOS COLOR FINISH CHART

PROJECT _____
TYPE _____
SPECIFIER _____
QUANTITY _____
DATE _____

Fixture Finish

White - WHI



Black - BLK

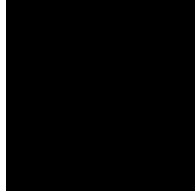

Pastel Blue - PBL

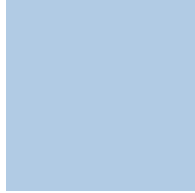

Pastel Ochre - POR



Pastel Green - PGN



Copper - COP



New Gold - NGD



Pink Metal - PKM



Silver - SIL



Digital: Not all screens are calibrated the same, and therefore, colors will appear differently between screens.











Physical: When texture is involved, there will be variations in color, character and tone within a product series and between product families.













LEGEND

	floor-mounted		pivotal		special LED (upon request) RGB, RGBW, tunable, gold+, meat+, art+, fashion+
	wall and ceiling: recessed and surface mounted		rotating		warm dim / natural dimming LED
	ceiling-mounted and wall-mounted		illuminate tilted		rechargeable battery powered
	wall-mounted		color of suspension cable		fixture with natural vivid LED (upon request)
	omni-directional light distribution		length of suspension cable		color rendering index
	direct light distribution		reflector degree selection		color temperature
	direct/indirect light distribution		super spot		lumen (luminous flux)
	indirect light distribution		lens		efficacy (lumens per watt)
	asymmetric light distribution		lens pack		Unified Glare Rating (UGR) range from 5-40
	aura light distribution		shine ring		marine grade (AISI 316 stainless steel)
	round wall or ceiling cut-out		integrated shine ring with diffuser		walk on
	square wall or ceiling cut-out		free individual colors 01-29		drive on
	the supplied jig specifies the cutout dimensions		individual colors: 00 (free of charge), 01-25 (extra charge)		Dark Sky Compliance
	minimum distance (meters) lamp - object		luminaire part to be colored (F1)		Americans with Disabilities Act (less than 4" off the wall located between 27"-84" from floor)
	recessed depth		luminaire part to be colored (F2)		lamp protected against explosion
	ceiling thickness in mm		luminaire part to be colored (F3)		blown glass using traditional methods by master glass blower
	ceiling thickness selection		luminaire part to be colored (F4)		acoustic material
	dimnable DP (phase), DV (0-10V), DD (dali), DS (step-dim)		luminaire part to be colored (F5)		protection class I, protection insulation
	included or excluded LED driver/transformer/control gear		color of 3-circuit adaptor		protection class II, protection insulation
	separately switchable		indirect diffuser		ETL Certified to UL and CSA Standards
	sensor		direct diffuser		UL Certified to UL and CSA Standards
	remote control		ball-proof (upon request)		CSA Certified to UL and CSA Standards
	available upon request		accessory		Certified for North American Standards

IP RATING

	protected against ingress of solid bodies greater than 12.5mm (finger)
	protected against ingress of solid bodies greater than 2.5mm protected against sprays of water up to 60 degrees from the vertical (rain)
	protected against ingress of solid bodies greater than 1mm (wire) no protection against the ingress of moisture
	protected against ingress of solid bodies greater than 1mm (wire) protected against sprays of water up to 60 degrees from the vertical (rain)
	protected against ingress of solid bodies greater than 1mm (wire) protected against water splashed from all directions
	protected against limited ingress of dust (wet rooms/covered outdoor areas) protected against water splashed from all directions
	protected against ingress of dust protected against jets of water
	protected against ingress of dust protected against powerful jets of water or heavy seas
	protected against ingress of dust protected against immersion of water between 15cm - 1m for 30 minutes
	protected against ingress of dust protected against immersion of water under pressure for long periods

IK RATING

	protected against 0.14 joules impact (equivalent to 0.25kg mass dropped from 56mm above the surface)
	protected against 0.2 joules impact (equivalent to 0.25kg mass dropped from 80mm above the surface)
	protected against 0.35 joules impact (equivalent to 0.25kg mass dropped from 140mm above the surface)
	protected against 0.5 joules impact (equivalent to 0.25kg mass dropped from 200mm above the surface)
	protected against 0.7 joules impact (equivalent to 0.25kg mass dropped from 280mm above the surface)
	protected against 1 joules impact (equivalent to 0.25kg mass dropped from 400mm above the surface)
	protected against 2 joules impact (equivalent to 0.5kg mass dropped from 400mm above the surface)
	protected against 5 joules impact (equivalent to 1.7kg mass dropped from 300mm above the surface)
	protected against 10 joules impact (equivalent to 5.0kg mass dropped from 200mm above the surface)
	protected against 20 joules impact (equivalent to 5.0kg mass dropped from 400mm above the surface)